

# NUVO<sup>®</sup>

## DECORATIVE LIGHTING CATALOG





DECORATIVE LIGHTING  
GENERAL ILLUMINATION  
EXTERIOR LIGHTING  
ACCENT LIGHTING



# NUVO LIGHTING

SATCO'S DECORATIVE LIGHTING BRAND SINCE 2005

**QUALITY**

**ON-TREND STYLE**

**STRONG VALUE**

**VAST SELECTION**

SATCO®|NUVO® offers one of the largest selections of decorative lighting. For over sixty years, we have been innovating lighting solutions for the hospitality, multi-family, and many other industries, providing solutions for nearly every aspect from the front of the house to back, and everywhere in between.

Today, SATCO|NUVO's decorative offering includes hundreds of styles designed to capture the essence of today's design trends and are manufactured with great attention to quality, detail, and durability.

SATCO|NUVO offers a value that extends beyond the beauty. Offering one of the largest in-stock inventory with warehousing near you. . . you can be certain your project needs are met and met on time.

---

**SATCO|NUVO is your trusted fixture solution**

KITCHENS  
BEDROOMS  
LIVING ROOMS  
BATHROOMS  
ENTRY WAYS



# RESIDENTIAL

A STYLISH COLLECTION OF INDOOR AND OUTDOOR HOME LIGHTING SOLUTIONS

**ELEVATE AMBIANCE WITH OUR DIVERSE RANGE OF LIGHTING SOLUTIONS, ENSURING THE PERFECT ATMOSPHERE FOR EVERY ROOM. THE IDEAL BLEND OF STYLE AND VALUE WHILE CREATING A WELCOMING ENVIRONMENT.**



KITCHENS  
BEDROOMS  
LIVING ROOMS  
BATHROOMS  
ENTRY WAYS



# MULTI-FAMILY

QUALITY, A VAST SELECTION OF STYLES AND VALUE THAT  
WORK FOR TODAY'S LIGHTING PROJECTS

**ACHIEVE THE IDEAL BALANCE OF STYLE AND EFFICIENCY WHILE  
FOSTERING A WARM AND INVITING ENVIRONMENT WITH OUR  
DIVERSE RANGE OF LIGHTING SOLUTIONS-DESIGNED TO CREATE  
THE PERFECT ATMOSPHERE FOR EVERY ROOM.**



GUESTROOMS  
CORRIDORS  
MEETING ROOMS  
LOBBY/FRONT DESK  
POOLS/DECKS



# HOSPITALITY

QUALITY, A VAST SELECTION OF IN-STOCK STYLE AND A VALUE THAT WORKS FOR TODAY'S SPECIFIER MARKET

**STYLE THAT WELCOMES GUESTS & INCREASES VALUE**

**QUALITY & DURABILITY THAT IS EASY TO MAINTAIN**

**FIXTURES MADE FOR STYLE, SAFETY & SAVINGS**





15

**INTERIOR EXPRESSIONS**

Elevate your living spaces with our stunning collection of residential decorative lighting.

255

**NUVO BASICS**

Contemporary lighting solutions, perfect for everyday spaces.



291

**FUNCTIONAL SOLUTIONS**

Light up spaces with our practical and durable selection of functional fixtures.

313

**TRACK LIGHTING**

Brighten up your home with our premium collection of residential track lighting solutions.



347

**EXTERIOR LIGHTING DESIGN**

Illuminate outdoor areas with our diverse collection of exterior lighting fixtures.

# CONTENTS

## INTERIOR EXPRESSIONS

Adina . . . . .	64	Cirrus . . . . .	104	Jackson LED . . . . .	190	Perkins . . . . .	73
Admiral . . . . .	72	Clarksville . . . . .	136	Jenkins LED . . . . .	195	PI LED . . . . .	241
Alexis . . . . .	50	Collins . . . . .	66	Jess LED . . . . .	187	Polaris . . . . .	178
Alondra . . . . .	78	Colony . . . . .	58	Kagen LED . . . . .	200	Pulse LED . . . . .	46
Altos . . . . .	54	Cora LED . . . . .	216	Kendall LED . . . . .	240	Roselle . . . . .	96
Amado . . . . .	88	Cordello . . . . .	124	Kenzo LED . . . . .	18	Rowen . . . . .	248
Antebellum . . . . .	95	Corinne LED . . . . .	43	Kettle . . . . .	56	Royale . . . . .	118
Arvada LED . . . . .	20	Cutty . . . . .	250	Kew . . . . .	253	Russel . . . . .	138
Asher LED . . . . .	26	Dale LED . . . . .	243	Kingsport LED . . . . .	40	Ryder . . . . .	102
Auden LED . . . . .	214	Darrow LED . . . . .	30	Lacey LED - STARFISH . . . . .	38	Sedona LED . . . . .	21
Aura LED . . . . .	36	Decker . . . . .	183	Lafayette . . . . .	70	Selene LED . . . . .	246
Axis . . . . .	100	Delaney . . . . .	239	Laguna . . . . .	164	Sherwood . . . . .	142
Bahari . . . . .	82	Delphi . . . . .	103	Lake . . . . .	172	Sky . . . . .	99
Bandon LED . . . . .	42	Donzi LED . . . . .	226	Lakeshore . . . . .	69	Skybridge . . . . .	140
Barnett LED . . . . .	23	Dover . . . . .	74	Lansing . . . . .	114	Skyloft . . . . .	98
Barrique . . . . .	53	Dupont . . . . .	176	Larissa LED . . . . .	204	Slice LED . . . . .	194
Basel . . . . .	92	Easton . . . . .	116	Lena LED . . . . .	210	Slick LED . . . . .	193
Bayard . . . . .	238	Edgeworth LED . . . . .	201	Liam . . . . .	132	Sloan . . . . .	234
Beaker . . . . .	81	Edmond LED . . . . .	37	Lightcap . . . . .	63	Soho . . . . .	182
Bellcap . . . . .	62	Ellusion LED . . . . .	222	Link . . . . .	47	Solano LED . . . . .	197
Bend LED . . . . .	188	Emma . . . . .	107	Loop . . . . .	189	Solara . . . . .	130
Bento . . . . .	156	Evander LED . . . . .	34	Longford LED . . . . .	33	Sommerset . . . . .	160
Blaine LED . . . . .	32	Everton . . . . .	68	Lune . . . . .	122	Spirefly . . . . .	105
Boliver . . . . .	89	Faro . . . . .	90	Marina . . . . .	52	Spyglass . . . . .	80
Bond LED . . . . .	202	Flush Fixture LED . . . . .	247	Marlowe . . . . .	154	Surrey . . . . .	168
Bow LED . . . . .	191	Frame LED . . . . .	48	Melrose LED . . . . .	45	Sylas LED . . . . .	29
Bowman LED . . . . .	198	Frankie . . . . .	112	Mercer LED . . . . .	212	Tango . . . . .	60
Bransel . . . . .	162	Gemini . . . . .	111	Mila LED . . . . .	220	Teresa . . . . .	83
Brewster . . . . .	110	Geneva LED . . . . .	24	Mobili . . . . .	180	Thompson . . . . .	231
Bridgeview . . . . .	76	Gianna . . . . .	120	Motif . . . . .	51	Trax LED . . . . .	225
Brightwyn LED . . . . .	306	Ginger . . . . .	174	Neval . . . . .	249	Tribeca . . . . .	228
Brookside . . . . .	125	Glacier . . . . .	184	Nova LED . . . . .	28	Trilby . . . . .	236
Bruge . . . . .	94	Grayson . . . . .	134	Odeon . . . . .	158	Tucker LED . . . . .	224
Button LED . . . . .	242	Grill LED . . . . .	192	Orbit LED . . . . .	31	Valdora . . . . .	71
Caleta . . . . .	146	Hartley . . . . .	93	Olmstead . . . . .	230	Vale LED . . . . .	22
Canal LED . . . . .	196	Hawk LED . . . . .	223	Outpost . . . . .	65	Valentine . . . . .	128
Candice . . . . .	113	Hazel LED . . . . .	218	Parallel . . . . .	179	Velano LED . . . . .	208
Caper LED . . . . .	211	Heather LED . . . . .	245	Parker . . . . .	185	Vesey . . . . .	232
Century LED . . . . .	44	Highline . . . . .	233	Patton . . . . .	170	Vintage . . . . .	84
Chantecleer . . . . .	252	Idris LED . . . . .	16	Payne . . . . .	152	Vista . . . . .	186
Chassis . . . . .	150	Intention . . . . .	148	Peak LED . . . . .	227	Warren . . . . .	144
		Intersection . . . . .	126	Pendleton . . . . .	108	Willow . . . . .	166

On the Cover:  
"Asher", designed  
with modern living in  
mind, page 26.



# CONTENTS (CONTINUED)

## NUVO BASICS

Chandeliers	256
Close-To-Ceiling	260
Pendants	278
Sconces	286
Vanities	282
Vanity / Wall Fixtures	288
Warehouse Pendants	281

## FUNCTIONAL

4" Surface Mounts	304
18" Wrap Fixture	309
Blink Performer	298
Blink Pro	294
Blink Pro+	296
Bulkhead	415
Cloud Fixtures	307
Crispo	302
Disk Lights	306
Glamour	300
Strip Fixtures	298
Twist & Lock	310
Wrap Fixtures	308

## TRACK LIGHTING

Accessories	342
LED Monopoints	316
LED Track Heads	317
LED Track Kits	338
Starfish Track Heads	314
Track Heads	334
Track Kits	340

## EXTERIOR LIGHTING

Adams	422
Accessories	458
Atmosphere LED	350
Austen	373
Austen LED	370

Banyan	424
Bethany LED	366
Boxwood	426
Briton	438
Broadstone	388
Bulkhead	441
Carport Flush Mount	450
Spider Cage	412
Central Park	432
Colt LED	356
Cornerstone	436
Corning	394
Cove Neck	429
Cradle LED	348
Crew LED	358
Cube	441
Diego LED	364
Drexel	404
East River	372
East River LED	368
Easton	109
Exhibit	400
Halifax	392
Holden	398
Homestead	402
Hopewell	390
Hopkins	378
Howell	408
Huron	386
Indie	418
Industrial Style	448
Jamesport	381
Lakeview	380
Landscape PAR	456
Lansing	382
Lawrence	375
Ledges LED	354
Lightgate LED	361
Luca	396
Morris	412
Newbridge	416

Oaklyn	376
Onion	440
PAR Floodlights	454
Pathway	457
Piper	440
Polaris	168
Poly	453
Porch Wall	452
Raiden	379
Raven LED	360
Ridge	414
Stillwell	374
Sullivan	395
Supreme LED	352
Tofino	384
Vega	410
Willis LED	362
Wilton	389
Wingate	406

On right page:  
"CREW", designed with  
modern sophistication,  
page 358







# INTERIOR expressions

---

## DESIGN THAT ELEVATES

Each NUVO fixture is conceived and engineered to deliver ease of installation and beautiful, functional lighting performance with style.

Select the perfect lighting fixture for your home or project from hundreds of on-trend concepts which offer exceptional design and value while delivering on quality, performance and reliability.





# IDRIS LED

## EDGE LIT LED WITH LIGHT GUIDE PANEL

Contemporary design meets innovative illumination with the Idris Collection. Designed for those who value cutting-edge style and subtle elegance, Idris redefines lighting as both functional and artistic.

### FINISH



Vintage Brass



62-2414 - 6" W



62-2415 - 25" W

ITEM	DESCRIPTION	FINISH	LIGHT SOURCE	WATTS	LENGTH	WIDTH	HEIGHT	EXT	CCT	LUMENS	CRI	CERT. TYPE
62-2411	Island Pendant	Vintage Brass	LED	26W	40.25"	5.25"	5.25"	*	3000K	2080	90	Dry
62-2412	4 Lt. Pendant	Vintage Brass	LED	37W	*	13"	16.5"	*	3000K	2960	90	Dry
62-2413	3 Lt. Pendant	Vintage Brass	LED	26W	*	11.5"	16.5"	*	3000K	2080	90	Dry
62-2414	1 Lt. Wall Sconce	Vintage Brass	LED	9W	*	6"	16.5"	6.25"	3000K	720	90	Dry
62-2415	3 Lt. Wall Sconce	Vintage Brass	LED	19W	*	24.5"	5.25"	6.75"	3000K	1520	90	Dry



Additional Stems: (6") 25-3086, (12") 25-3087 | (2) x 6" Stems and (2) x 12" Stems Included  
 Island Pendant Includes: (4) x 6" Stems and (4) x 12" Stems





# KENZO LED

## EDGE LIT LED WITH LIGHT GUIDE PANEL

Unveil the art of Modern design with the Kenzo Collection, where bold geometric styling meets sculptural elegance. Perfect for those who appreciate imagination, it is more than lighting in motion, it's a statement to the ingenuity and style of today's luminaires.

### FINISH



Polished Anodized  
Bronze



62-2408 - 25" W



62-2407 - 8" W

ITEM	DESCRIPTION	FINISH	LIGHT SOURCE	WATTS	LENGTH	WIDTH	HEIGHT	EXT	CCT	LUMENS	CRI	CERT. TYPE
62-2401	5 Lt. Flush Mount	Polished Anodized Bronze	LED	48W	•	17.75"	7.63"	8.5"	3000K	3840	90	Dry
62-2402	6 Lt. Flush Mount	Polished Anodized Bronze	LED	58W	•	20.5"	7.63"	8.5"	3000K	4640	90	Dry
62-2403	6 Lt. Chandelier	Polished Anodized Bronze	LED	58W	•	20.5"	5.5"	8.5"	3000K	4640	90	Dry
62-2404	12 Lt. Chandelier	Polished Anodized Bronze	LED	120W	•	34.25"	5.5"	8.5"	3000K	9600	90	Dry
62-2405	6 Lt. Island Pendant	Polished Anodized Bronze	LED	48W	37.13"	10.25"	5.5"	8.5"	3000K	3840	90	Dry
62-2406	2 Lt. Mini Pendant	Polished Anodized Bronze	LED	12W	13.63"	7.63"	8.13"	8.5"	3000K	960	90	Dry
62-2407	1 Lt. Wall Sconce	Polished Anodized Bronze	LED	6W	•	7.63"	5.7"	8.5"	3000K	480	90	Dry
62-2408	3 Lt. Vanity	Polished Anodized Bronze	LED	15W	•	25"	5.7"	8.5"	3000K	1200	90	Dry



Cable Length: 8'



62-2403 - 21" W



62-2404 - 34" W



62-2401 - 18" W (shown)



62-2405 - 37" L



62-2406 - 14" L



# ARVADA LED

## EDGE LIT LED WITH LIGHT GUIDE PANEL

Designed with modern living in mind, the Arvada Collection seamlessly integrates cutting-edge technology with timeless design. These pendants are designed to captivate, setting the state for ambiance and unforgettable moments.

ITEM	DESCRIPTION	FINISH	LIGHT SOURCE	WATTS	WIDTH	HEIGHT	CCT	LUMENS	CRI	CERT TYPE
62-2031	Round Pendant	Matte Black w/ Silk Screened Acrylic	LED	24W	8.75"	7.88"	3000K	1920	90	Dry
62-2032	Round Pendant	Matte Black w/ Silk Screened Acrylic	LED	31W	12.63"	11.75"	3000K	2480	90	Dry
62-2033	Round Pendant	Matte Black w/ Silk Screened Acrylic	LED	39W	16.63"	15.75"	3000K	3120	90	Dry
62-2034	Round Pendant	Matte Black w/ Silk Screened Acrylic	LED	47W	20.5"	19.63"	3000K	3760	90	Dry



Pendants: 9' of Wire Supplied



62-2034 - 20" W (shown)



62-2032 - 12" W (shown)

### FINISH



Matte Black w/  
Silk Screened Acrylic

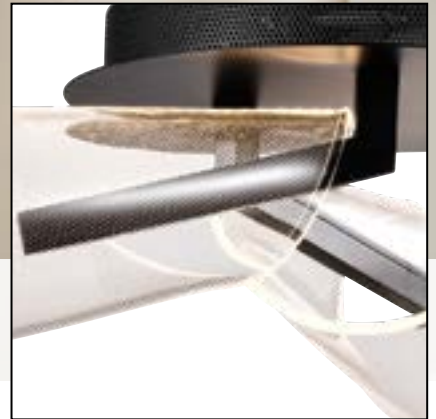

# SEDONA LED

## EDGE LIT LED WITH LIGHT GUIDE PANEL

For a touch of modern sophistication, the Sedona Collection delivers ambiance with a uniquely artistic twist. Embrace the future of lighting with this radiant collection, where every piece is not just a source of light but a true work of art.

ITEM	DESCRIPTION	FINISH	LIGHT SOURCE	WATTS	WIDTH	HEIGHT	EXT.	CCT	LUMENS	CRI	CERT TYPE
62-2281	6 Lt. Chandelier	Matte Black w/ Silk Screened Acrylic	LED	31W	28"	9.875"	*	3000K	2480	90	Dry
62-2282	1 Lt. Sconce	Matte Black w/ Silk Screened Acrylic	LED	8W	5.13"	12.25"	7.25"	3000K	640	90	Dry
62-2283	4 Lt. Chandelier	Matte Black w/ Silk Screened Acrylic	LED	24W	27.13"	9.88"	*	3000K	1920	90	Dry
62-2284	3 Lt. Flush Mount	Matte Black w/ Silk Screened Acrylic	LED	18W	22"	7.5"	*	3000K	1440	90	Dry



Additional Stems: (6") 25-3041, (12") 25-3042 (2) x 6" Stems and (2) x 12" Stems Included with Chandeliers

Sconce: CUL listed for Up or down installation

Chandelier: 9' of Wire Supplied



62-2281 - 28" W



62-2282- 13" W



62-2283 - 27" W

### FINISH



Matte Black w/  
Silk Screened Acrylic



62-2284- 22" W



# VALE LED

## EDGE LIT LED WITH LIGHT GUIDE PANEL

Elevate your living spaces with the Vale Collection, the marriage of modern ingenuity and artistic finesse. A refined addition to any space in need of a touch of modern sophistication, with it's harmonious blend of artistry and glamour. Illuminate your home and bask in the radiant elegance of contemporary design.

ITEM	DESCRIPTION	FINISH	LIGHT SOURCE	WATTS	LENGTH	WIDTH	HEIGHT	EXT.	CCT	LUMENS	CRI	CERT TYPE
62-2041	Island Pendant	Matte Black w/ Silk Screened Acrylic	LED	32W	43.5"	4.75"	5.38"	*	3000K	2560	90	Dry
62-2042	Sconce	Matte Black w/ Silk Screened Acrylic	LED	8W	*	4.75"	11.75"	6.25"	3000K	640	90	Dry



Sconce: cETLus listed for horizontal or vertical installation  
Island Pendant: 9' of Wire Supplied



62-2042 - 12" Ht



62-2041 - 44" L

### FINISH



Matte Black w/  
Silk Screened Acrylic



# BARNETT LED

## EDGE LIT LED WITH LIGHT GUIDE PANEL

It's not merely about aesthetics, it's a testament to innovation from design to execution, and the Barnett Series is your ticket to eclectic, fun lighting! These fixtures aren't just lights, turn your space into a canvas, resplendent with eccentric, modern charisma, and a captivating play of light and shadow.

ITEM	DESCRIPTION	FINISH	LIGHT SOURCE	WATTS	WIDTH	HEIGHT	EXT.	CCT	LUMENS	CRI	CERT TYPE
62-2035	Flush Mount	Matte Black w/ Silk Screened Acrylic	LED	24W	20.88"	7.63"	*	3000K	1920	90	Dry
62-2036	Light Chandelier	Matte Black w/ Silk Screened Acrylic	LED	24W	20.88"	7.75"	*	3000K	1920	90	Dry
62-2037	Sconce	Matte Black w/ Silk Screened Acrylic	LED	8W	7.5"	9.5"	6.88"	3000K	640	90	Dry



Sconce: cETLus listed for Up or down installation

Chandelier: 9' of Wire Supplied



62-2035 - 21" W



62-2037 - 10" Ht

### FINISH



Matte Black w/  
Silk Screened Acrylic



62-2036 - 21" W



# GENEVA LED

## EDGE LIT LED WITH LIGHT GUIDE PANEL

Step into a realm of contemporary sophistication with the Geneva Collection - where modern design meets artistic flair. This combination of technology and artistry creates a mesmerizing play of light, infusing your space with a sense of modern charm.

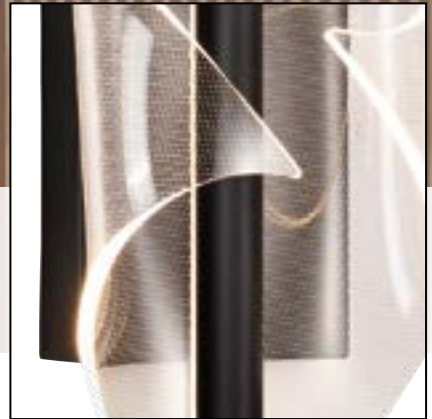

### FINISH



Matte Black w/  
Silk Screened Acrylic



62-2024 - 18" W

ITEM	DESCRIPTION	FINISH	LIGHT SOURCE	WATTS	LENGTH	WIDTH	HEIGHT	EXT.	CCT	LUMENS	CRI	CERT TYPE
62-2021	Sm. Wall Sconce	Matte Black w/ Silk Screened Acrylic	LED	24W	*	6.25"	17.75"	4.13"	3000K	1920	90	Dry
62-2022	Lg. Wall Sconce	Matte Black w/ Silk Screened Acrylic	LED	27W	*	6.75"	23.63"	4.75"	3000K	2160	90	Dry
62-2023	Island Pendant	Matte Black w/ Silk Screened Acrylic	LED	47W	46.88"	11.75"	8.25"	*	3000K	3760	90	Dry
62-2024	Flush Mount	Matte Black w/ Silk Screened Acrylic	LED	24W	*	17.75"	4.75"	*	3000K	1920	90	Dry
62-2025	Pendant	Matte Black w/ Silk Screened Acrylic	LED	24W	*	17.75"	4.75"	*	3000K	1920	90	Dry



Sconces: cETLus listed for horizontal or vertical installation

Pendants: 9' of Wire Supplied



62-2021 - 18" Ht (shown)



62-2025 - 18" W



62-2023 - 47" L

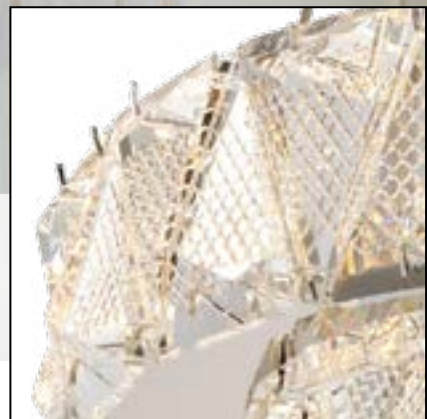

# ASHER LED

Featuring luxurious K9 crystal, each piece of the Asher Collection sparkles with brilliance and sophistication, reflecting the light to mesmerizing effect. The perfect melding of timeless luxury and modern flair, transforming any room into an oasis of elegance and illumination.

## FINISH



Polished Nickel / K9 Crystal

ITEM	DESCRIPTION	FINISH	LIGHT SOURCE	WATTS	LENGTH	WIDTH	HEIGHT	CCT	LUMENS	CRI	CERT TYPE
62-2441	16" Round K9 Crystal Pendant	Polished Nickel / K9 Crystal	LED	27W	•	15.75"	2.5"	3000K	2160	90	Dry
62-2442	36" Round K9 Crystal Pendant	Polished Nickel / K9 Crystal	LED	50W	•	35.5"	2.5"	3000K	4000	90	Dry
62-2443	36" Oval K9 Crystal Pendant	Polished Nickel / K9 Crystal	LED	50W		35.75"	11.75"	3000K	4000	90	Dry



9' of Wire Supplied with Pendants



62-2442 - 36" W



62-2441 - 16" W



62-2443 - 36" L



# NOVA LED

Encounter the Nova Collection, where contemporary crystal design meets classic elegance. Crafted with luxurious K9 crystal, each piece shines with exquisite clarity, casting a radiant glow throughout your space.

ITEM	DESCRIPTION	FINISH	LIGHT SOURCE	WATTS	LENGTH	WIDTH	HEIGHT	CCT	LUMENS	CRI	CERT TYPE
62-2444	23" Round K9 Crystal Flush Mount	Polished Nickel / K9 Crystal	LED	34W	•	22.88"	3.88"	3000K	2720	90	Dry
62-2445	16" K9 Crystal Mini Pendant	Polished Nickel / K9 Crystal	LED	12W	3"	1.38"	16"	3000K	960	90	Dry
62-2446	23" Round K9 Crystal Pendant	Polished Nickel / K9 Crystal	LED	34W	•	22.88"	1.25"	3000K	2720	90	Dry
62-2447	36" Round K9 Crystal Pendant	Polished Nickel / K9 Crystal	LED	48W	•	35.88"	1.25"	3000K	3840	90	Dry



9' of Wire Supplied with Pendants



62-2445 - 16 " Ht



62-2447 - 36" W (shown)

## FINISH



Polished Nickel /K9 Crystal



62-2444 - 23" W

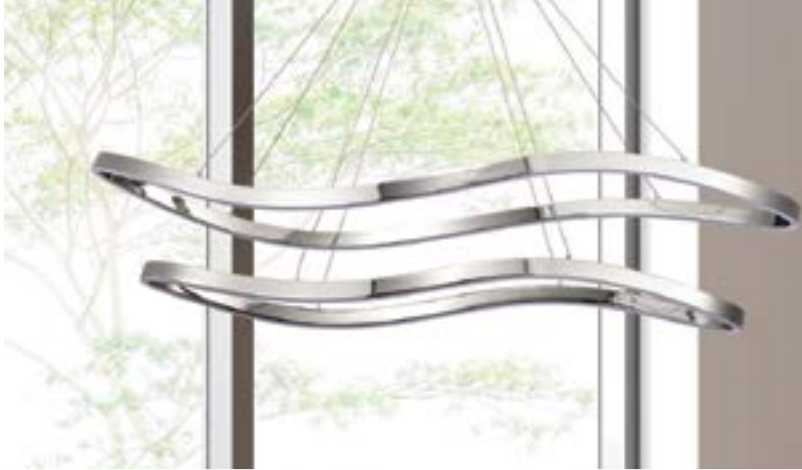

# SYLAS LED

Embrace the beauty of organic design with the Sylas Collection, a whimsical light sculpture that redefines the art of lighting. Its free-form silhouette is comprised of a fluid-like, sculptural frame evoking a sense of movement and creativity.

ITEM	DESCRIPTION	FINISH	LIGHT SOURCE	WATTS	LENGTH	WIDTH	HEIGHT	CCT	LUMENS	CRI	CERT TYPE
62-2421	37" Pendant	Matte Black	LED	64W	•	37.4"	8.4"	3000K	5120	90	Dry
62-2431	37" Pendant	Polished Nickel	LED	64W	•	37.4"	8.4"	3000K	5120	90	Dry
62-2422	48" Pendant	Matte Black	LED	64W	20.1"	48"	10.1"	3000K	5120	90	Dry
62-2432	48" Pendant	Polished Nickel	LED	64W	20.1"	48"	10.1"	3000K	5120	90	Dry



9' of Wire Supplied with Pendants



62-2421 - 37" W (shown)  
Matte Black



62-2432 - 48" W (shown)  
Polished Nickel

## FINISH OPTIONS



Matte Black



Polished Nickel

# DARROW LED

The Darrow Collection is not just a lighting ensemble; it's a testament to the artistry of design. Elevate your home and usher in a new era of transitional design for the modern home.



ITEM	DESCRIPTION	FINISH	LIGHT SOURCE	WATTS	WIDTH	HEIGHT	VOLTS	CCT	LUMENS	CRI	CERT TYPE
62-2001	Semi Flush	Matte Black w/ Acrylic Panels	LED	30W	14"	7.50"	120-277	3000K	2400	90	Dry
62-2002	Flush Mount	Matte Black w/ Acrylic Panels	LED	30W	14"	3.88"	120-277	3000K	2400	90	Dry
62-2003	Pendant	Matte Black w/ Acrylic Panels	LED	40W	24"	23.00"	120-277	3000K	3200	90	Dry
62-2011	Semi Flush	Vintage Brass w/ Acrylic Panels	LED	30W	14"	7.50"	120-277	3000K	2400	90	Dry
62-2012	Flush Mount	Vintage Brass w/ Acrylic Panels	LED	30W	14"	3.88"	120-277	3000K	2400	90	Dry
62-2013	Pendant	Vintage Brass w/ Acrylic Panels	LED	40W	24"	23.00"	120-277	3000K	3200	90	Dry



Additional Stems: (6") 25-498, (6") 25-3086, (12") 25-499, (12") 25-3087

(2) x 6" Stems and (2) x 12" Stems Included

Pendants: 9' of Wire Supplied



62-2001 - 14" W (shown)  
Matte Black



62-2012 - 14" W (shown)  
Vintage Brass

## FINISH OPTIONS



Matte Black w/  
Acrylic Panels



Vintage Brass w/  
Acrylic Panels



62-2003 - 24" W (shown)  
Matte Black



# ORBIT LED

CCT SELECTABLE - 3000K | 4000K | 5000K

Simplicity, form, and function best describe the Orbit LED flush mount. This fixture is sure to compliment already existing finishes and décor, providing the longevity and the latest technology for lighting and energy-saving needs.

ITEM	DESCRIPTION	FINISH	LIGHT SOURCE	WATTS	WIDTH	HEIGHT	VOLTS	CCT	LUMENS	CRI	CERT. TYPE
62-1451R1	Flush Mount	White	LED	20W	18"	6.06"	120-277	3000K/4000K/5000K	1426-1539	90	Dry
62-1452R1	Flush Mount	Black	LED	20W	18"	6.06"	120-277	3000K/4000K/5000K	1426-1539	90	Dry
62-1453R1	Flush Mount	White	LED	30W	24"	6.00"	120-277	3000K/4000K/5000K	2033-2314	90	Dry
62-1454R1	Flush Mount	Black	LED	30W	24"	6.00"	120-277	3000K/4000K/5000K	2033-2314	90	Dry
62-1455R1	Pendant	White	LED	20W	18"	4.38"	120-277	3000K/4000K/5000K	1426-1539	90	Dry
62-1456R1	Pendant	Black	LED	20W	17.75"	4.38"	120-277	3000K/4000K/5000K	1426-1539	90	Dry
62-1457R1	Pendant	White	LED	30W	23.5"	4.38"	120-277	3000K/4000K/5000K	2033-2314	90	Dry
62-1458R1	Pendant	Black	LED	30W	23.5"	4.38"	120-277	3000K/4000K/5000K	2033-2314	90	Dry



Pendants: 12' of wire and cable supplied



62-1451R1 - 18" W (shown)  
White



62-1458R1 - 24" W (shown)  
Black

## FINISH OPTIONS



White



Black



# BLAINE LED

Dive into the sleek sophistication of the Blaine Collection, where modern design reigns supreme, and outstanding style takes center stage. In a world full of colors, sometimes monochrome steals the show, and Blaine will elevate your space into a minimalist masterpiece.

ITEM	DESCRIPTION	FINISH	LIGHT SOURCE	WATTS	LENGTH	WIDTH	HEIGHT	CCT	LUMENS	CRI	CERT TYPE
62-2141	16" Pendant	Matte Black / Acrylic Lens	LED	18W	15.75"	15.76"	4.75"	3000K	1300	90	Dry
62-2151	13" Pendant	Matte Black / Acrylic Lens	LED	30W	12.875"	12.88"	13.63"	3000K	2150	90	Dry
62-2161	38" Island Pendant	Matte Black / Acrylic Lens	LED	42W	37.38"	7.88"	9.50"	3000K	3000	90	Dry



Additional Stems: (6") 25-3041, (12") 25-3042  
 (2) x 6" Stems and (2) x 12" Stems Included  
 Pendants: 12' of Wire Supplied



62-2161 - 37" L



62-2141 - 16" W



62-2151- 13" W

## FINISH



Matte Black /  
Acrylic Lens



# LONGFORD LED

Unveiling the Longford Series, a masterful blend of modern aesthetics and cutting-edge technology. Transform your environment into a landscape of elegance, minimalist design, and a beacon of LED brilliance, illuminating your world with style that transcends trends.

ITEM	DESCRIPTION	FINISH	LIGHT SOURCE	WATTS	LENGTH	WIDTH	HEIGHT	CCT	LUMENS	CRI	CERT TYPE
62-2261	20" Pendant	Textured Black/ Acrylic Lens	LED	21W	•	20.13"	23.38"	3000K	1700	90	Dry
62-2262	30" Pendant	Textured Black/ Acrylic Lens	LED	30W	•	30"	23.38"	3000K	2500	90	Dry
62-2263	36" Island Pendant	Textured Black/ Acrylic Lens	LED	39W	36"	2.75"	2"	3000K	3315	90	Dry



Additional Stems: (6") 25-342, (12") 25-343  
 (2) x 6" Stems and (2) x 12" Stems Included  
 Pendants: 12' of Wire Supplied



62-2262 - 30" W (shown)



62-2263 - 36" L

## FINISH



Textured Black / Acrylic Lens



# EVANDER LED

Discover the refined beauty of the Evander Collection, where modern LED design meets minimalist elegance. With its clean lines and subtle detailing, this collection projects quiet sophistication, offering a perfect balance of form and function.

## FINISH



Matte Black w/  
Smoked Glass



62-2453 - 5" W

ITEM	DESCRIPTION	FINISH	LIGHT SOURCE	WATTS	LENGTH	WIDTH	HEIGHT	EXT.	CCT	LUMENS	CRI	CERT TYPE
62-2451	16" Mini Pendant	Matte Black w/ Smoked Glass	LED	14W	•	2.75"	16.6"	•	3000K	1120	90	Dry
62-2452	50" Island Pendant	Matte Black w/ Smoked Glass	LED	50W	50"	2.75"	2.75"	•	3000K	4000	90	Dry
62-2453	1 Lt. Wall Sconce	Matte Black w/ Smoked Glass	LED	12W	•	4.75"	15.13"	4.13"	3000K	960	90	Dry



9' of Wire Supplied with Pendants



62-2452 - 50" L



62-2451 - 6" W



# AURA LED

A fusion of contemporary style and classic allure, the exquisite Aura Collection is a suite of elegantly crafted pendants for today's style. A dance of light awaits with integrated LED shining through a K9 bubble crystal column. Picture your space transformed with beautiful simplicity, the latest technology, and design that is a celebration of here and now.

ITEM	DESCRIPTION	FINISH	LIGHT SOURCE	WATTS	WIDTH	HEIGHT	VOLTS	CCT	LUMENS	CRI	CERT TYPE
62-2171	7" Pendant	Matte Black / K9 Bubble Crystal	LED	12W	7.25"	10"	120V	3000K	1020	90	Dry
62-2172	12" Pendant	Matte Black / K9 Bubble Crystal	LED	12W	12"	11.5"	120V	3000K	1020	90	Dry
62-2181	7" Pendant	Brushed Brass / K9 Bubble Crystal	LED	12W	7.25"	10"	120V	3000K	1020	90	Dry
62-2182	12" Pendant	Brushed Brass / K9 Bubble Crystal	LED	12W	12"	11.5"	120V	3000K	1020	90	Dry
62-2191	7" Pendant	Brushed Nickel / K9 Bubble Crystal	LED	12W	7.25"	10"	120V	3000K	1020	90	Dry
62-2192	12" Pendant	Brushed Nickel / K9 Bubble Crystal	LED	12W	12"	11.5"	120V	3000K	1020	90	Dry



Additional Stems: Matte Black (6") 25-479, (12") 25-480, Brushed Brass (6") 25-468, (12") 25-469

Additional Stems: Brushed Nickel (6") 25-615, (12") 25-615

(2) x 6" Stems and (2) x 12" Stems Included

12' of Wire Supplied



62-2172 - 12" W (shown)  
Matte Black/  
K9 Bubble Crystal



62-2182 - 12" W (shown)  
Brushed Brass/  
K9 Bubble Crystal



62-2192 - 12" W (shown)  
Brushed Nickel/  
K9 Bubble Crystal

## FINISH OPTIONS



Brushed Brass/  
K9 Bubble Crystal



Matte Black/  
K9 Bubble Crystal



Brushed Nickel/  
K9 Bubble Crystal



# EDMOND LED

## 3-LIGHT LED PLUS CENTER DOWNLIGHT

The Edmond Collection seamlessly combines form and function, providing a balance of design and sustainability. Illuminate your surroundings with the latest in lighting, offering a contemporary twist to your home or office.

ITEM	DESCRIPTION	FINISH	LIGHT SOURCE	WATTS	WIDTH	HEIGHT	CCT	LUMENS	CRI	CERT TYPE
62-2051	14" Pendant	Polished Nickel/Clear Glass	LED	12W	13.63"	8.5"	3000K	1272	90	Dry
62-2052	17" Pendant	Polished Nickel/Clear Glass	LED	18W	17"	8.88"	3000K	1944	90	Dry
62-2053	14" Semi Flush	Polished Nickel/Clear Glass	LED	12W	13.63"	9"	3000K	1272	90	Damp
62-2054	17" Semi Flush	Polished Nickel/Clear Glass	LED	18W	17"	9.5"	3000K	1944	90	Damp
62-2061	14" Pendant	Matte Black/Clear Glass	LED	12W	13.63"	8.5"	3000K	1272	90	Dry
62-2062	17" Pendant	Matte Black/Clear Glass	LED	18W	17"	8.88"	3000K	1944	90	Dry
62-2063	14" Semi Flush	Matte Black/Clear Glass	LED	12W	13.63"	9"	3000K	1272	90	Damp
62-2064	17" Semi Flush	Matte Black/Clear Glass	LED	18W	17"	9.5"	3000K	1944	90	Damp



Additional Stems: Polished Nickel (6") 25-3088, (12") 25-3089, Matte Black (6") 25-485, (12") 25-486

(2) x 6" Stems and (2) x 12" Stems Included

Pendants: 12' of Wire Supplied



62-2054 - 17" W (shown)  
Polished Nickel



62-2061 - 14" W (shown)  
Matte Black

### FINISH OPTIONS



Polished Nickel w/  
Clear Glass



Matte Black w/  
Clear Glass



# LACEY LED



## WIFI ENABLED

The Lacey LED pendant collection combines sophisticated design with the advanced functionality of STARFISH® Smart technology. Featuring beautiful lead free bubble crystal, these fixtures create a stunning interplay of light, texture, and color.



Dynamic RGB  
Color-Changing  
& Tunable White



Millions of Colors

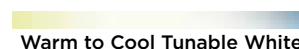

Warm to Cool Tunable White



## FINISH



Matte Black/  
K9 Bubble Crystal

ITEM	DESCRIPTION	FINISH	LIGHT SOURCE	WATTS	LENGTH	WIDTH	HEIGHT	EXT.	CCT	LUMENS	CRI	CERT TYPE
62-6001	Cylinder Mini Pendant	Matte Black / K9 Bubble Crystal	LED	11.5W	•	2.25"	13.13"	120V	RGBTW	1100	80	Damp
62-6002	Tear Drop Mini Pendant	Matte Black / K9 Bubble Crystal	LED	11.5W	•	3.75"	10.25"	120V	RGBTW	1100	80	Damp
62-6003	Island Pendant	Matte Black / K9 Bubble Crystal	LED	11.5W	22.75"	2.25"	2.25"	120V	RGBTW	1100	80	Damp



Additional Stems: (6") 25-479, (12") 25-480

Island Pendant: (2) x 6" Stems and (2) x 12" Stems Included

Pendants: 12' of Wire Supplied



62-6001 - 2" W



62-6002 - 4" W



62-6003 - 23" L



# KINGSPORT LED

Step into the realm of modern luxury with the Kingsport LED Fixtures, a dazzling embodiment of technology, and sophisticated design. Bridging the gap between modern and contemporary, these fixtures become focal points that redefine your space.

## FINISH



Matte Black /  
White Acrylic Lens



62-2131 - 20" Ht  
(vertical or horizontal mount optional)

ITEM	DESCRIPTION	FINISH	LIGHT SOURCE	WATTS	LENGTH	WIDTH	HEIGHT	EXT.	CCT	LUMENS	CRI	CERT TYPE
62-2131	20" Vanity	Matte Black / White Acrylic Lens	LED	15W	•	20.5"	4.75"	4.25"	3000K	1280	90	Damp
62-2132	44" Island Pendant	Matte Black / White Acrylic Lens	LED	38W	44.25"	2"	3.38"	•	3000K	2780	90	Dry



Additional Stems: (6") 25-465, (12") 25-466  
 (2) x 6" Stems and (2) x 12" Stems Included  
 Island Pendant: 12' of Wire Supplied



62-2132 - 44" L



# BANDON LED

Illuminate your space with the Bandon LED Collection, where sleek meets chic in a dance of modern design. It's not just about lighting a room, it's about lighting up your life with the latest in integrated LED, and fashion-forward design featuring flair and sophistication in a fun package.

ITEM	DESCRIPTION	FINISH	LIGHT SOURCE	WATTS	WIDTH	HEIGHT	VOLTS	CCT	LUMENS	CRI	CERT TYPE
62-3001	Pendant	Gray / Blue Textured Faux Leather	LED	40W	19.5"	2"	120V-277V	3000K	4026	90	Dry
62-3002	Flush Mount	Gray / Blue Textured Faux Leather	LED	40W	19.5"	3.25"	120V-277V	3000K	4026	90	Dry
62-3011	Pendant	Gray / Red Textured Faux Leather	LED	40W	19.5"	2"	120V-277V	3000K	4026	90	Dry
62-3012	Flush Mount	Gray / Red Textured Faux Leather	LED	40W	19.5"	3.25"	120V-277V	3000K	4026	90	Dry
62-3021	Pendant	Gray / Off White Textured Faux Leather	LED	40W	19.5"	2"	120V-277V	3000K	4026	90	Dry
62-3022	Flush Mount	Gray / Off White Textured Faux Leather	LED	40W	19.5"	3.25"	120V-277V	3000K	4026	90	Dry



Pendants: 9' of Wire Supplied



62-3012 - 20" W (shown)

Gray/Red  
Textured Faux  
Leather



62-3001 - 20" W (shown)

Gray / Blue  
Textured Faux  
Leather

## FINISH OPTIONS



Gray / Blue  
Textured Faux  
Leather

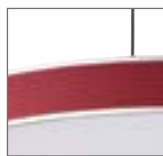

Gray / Red  
Textured Faux  
Leather



Gray / Off  
White Textured  
Faux Leather



# CORINNE LED

3-CCT SELECTABLE - 3000K | 4000K | 5000K

The Corrine Collection effortlessly marries style and substance, making it the epitome of understated modern design. Seamlessly blending into various interior styles, adorn your home as a statement piece that complements your discerning taste.

ITEM	DESCRIPTION	FINISH	LIGHT SOURCE	WATTS	WIDTH	HEIGHT	EXT.	VOLTS	CCT	LUMENS	CRI	CERT TYPE
62-2071	10" Pendant	Matte Black	LED	18W	9.88"	6.25"	•	120V	3000/4000/5000K	1500-1600	90	Dry
62-2072	14" Pendant	Matte Black	LED	18W	14"	6.38"	•	120V	3000/4000/5000K	1500-1600	90	Dry
62-2073	18" Pendant	Matte Black	LED	25W	18"	7.25"	•	120V	3000/4000/5000K	2100-2200	90	Dry
62-2074	10" Sconce	Matte Black	LED	18W	9.88"	7.25"	11.5"	120V	3000/4000/5000K	1500-1600	90	Damp
62-2081	10" Pendant	Brushed Nickel	LED	18W	9.88"	6.25"	•	120V	3000/4000/5000K	1500-1600	90	Dry
62-2082	14" Pendant	Brushed Nickel	LED	18W	14"	6.38"	•	120V	3000/4000/5000K	1500-1600	90	Dry
62-2083	18" Pendant	Brushed Nickel	LED	25W	18"	7.25"	•	120V	3000/4000/5000K	2100-2200	90	Dry
62-2084	10" Sconce	Brushed Nickel	LED	18W	9.875"	7.25"	11.5"	120V	3000/4000/5000K	1500-1600	90	Damp
62-2091	10" Pendant	Burnished Brass	LED	18W	9.875"	6.25"	•	120V	3000/4000/5000K	1500-1600	90	Dry
62-2092	14" Pendant	Burnished Brass	LED	18W	14"	6.38"	•	120V	3000/4000/5000K	1500-1600	90	Dry
62-2093	18" Pendant	Burnished Brass	LED	25W	18"	7.25"	•	120V	3000/4000/5000K	2100-2200	90	Dry
62-2094	10" Sconce	Burnished Brass	LED	18W	9.88"	7.25"	11.5"	120V	3000/4000/5000K	1500-1600	90	Damp



Pendants: 12' of Wire Supplied



62-2074 - 10" W (shown)  
Matte Black

## FINISH OPTIONS



Matte Black  
Gray Rayon Cord  
Gray Reflector



Brushed Nickel  
Gray Rayon Cord  
Gray Reflector



Burnished Brass  
Gray Rayon Cord  
Gray Reflector



62-2092 - 14" W (shown)  
Burnished Brass



# CENTURY LED

Modern lighting solutions offer contemporary styling at its finest with the Century pendants. The clean lines, minimalist shape and integrated LED all contribute to the design of these sleek fixtures, perfectly suited for today's decor.

ITEM	DESCRIPTION	FINISH	LIGHT SOURCE	WATTS	WIDTH	HEIGHT	VOLTS	CCT	LUMENS	CRI	CERT TYPE
62-816	36° Beam Angle	Matte Black	LED	12W	2.56"	16.06"	120V	3000K	1020L	90	Damp
62-817	36° Beam Angle	Matte White	LED	12W	2.56"	16.06"	120V	3000K	1020L	90	Damp
62-818	36° Beam Angle	Matte Black / Brushed Brass	LED	12W	2.56"	16.06"	120V	3000K	1020L	90	Damp
62-819	36° Beam Angle	Matte Black / Brushed Nickel	LED	12W	2.56"	16.06"	120V	3000K	1020L	90	Damp
62-820	36° Beam Angle	Ash Wood	LED	12W	2.56"	16.06"	120V	3000K	1020L	90	Damp



Optional Mounting Pendant Track Adapters: TP231 (White), TP-232 (Black)

8' of Wire Supplied



62-816  
Matte Black



62-817  
Matte White



62-818  
Matte Black/  
Brushed Brass



62-819  
Matte Black/  
Brushed Nickel



62-820  
Ash Wood

## FINISH OPTIONS



Matte Black



Matte White

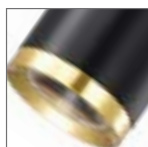

Matte Black  
Brushed Brass



Matte Black  
Brushed Nickel



Ash Wood



# MELROSE LED

Modern lighting solutions offer contemporary styling at its finest with the Melrose pendants. The clean lines, minimalist shape and integrated LED all contribute to the design of these sleek fixtures, perfectly suited for today's decor.

ITEM	DESCRIPTION	FINISH	LIGHT SOURCE	WATTS	WIDTH	HEIGHT	VOLTS	CCT	LUMENS	CRI	CERT TYPE
62-826	36° Beam Angle	Matte Black	LED	12W	2.40"	16.14"	120V	3000K	1020L	90	Damp
62-827	36° Beam Angle	Matte White	LED	12W	2.40"	16.14"	120V	3000K	1020L	90	Damp
62-828	36° Beam Angle	Matte Black / Brushed Brass	LED	12W	2.40"	16.14"	120V	3000K	1020L	90	Damp
62-829	36° Beam Angle	Matte Black / Brushed Nickel	LED	12W	2.40"	16.14"	120V	3000K	1020L	90	Damp
62-830	36° Beam Angle	Ash Wood	LED	12W	2.40"	16.14"	120V	3000K	1020L	90	Damp



Optional Mounting: Pendant Track Adapters: TP231 (White), TP-232 (Black)  
8' of Wire Supplied



62-826  
Matte Black



62-827  
Matte White



62-828  
Matte Black/  
Brushed Brass



62-829  
Matte Black/  
Brushed Nickel



62-830  
Ash Wood

## FINISH OPTIONS



Matte Black



Matte White



Matte Black/  
Brushed Brass



Matte Black/  
Brushed Nickel



Ash Wood



# PULSE LED



Enhance your kitchen's lighting with Pulse, a series of mini pendants that pack great style in illumination. Each pendant is available with it's own, distinctive shade, letting you choose which one is perfect for you lighting project.

ITEM	DESCRIPTION	FINISH	LIGHT SOURCE	WATTS	WIDTH	HEIGHT	VOLTS	CCT	LUMENS	CRI	CERT. TYPE
62-951	Mini Pendant	Brushed Nickel / Clear Seeded Glass	LED	12W	3"	10"	120V	3000K	950	80	Damp
62-952	Mini Pendant	Brushed Nickel / Crackle Glass	LED	12W	3"	10"	120V	3000K	950	80	Damp
62-953	Mini Pendant	Brushed Nickel / White Opal Glass	LED	12W	3"	10"	120V	3000K	950	80	Damp
62-954	Mini Pendant	Brushed Nickel / Mirrored Glass	LED	12W	3"	10"	120V	3000K	950	80	Damp
62-955	Mini Pendant	Brushed Nickel / Copper Glass	LED	12W	3"	10"	120V	3000K	950	80	Damp



12' of wire supplied



62-951 - 3" W  
Clear Seeded Glass



62-952 - 3" W  
Crackle Glass



62-953 - 3" W  
White Opal Glass



62-954 - 3" W  
Mirrored Glass



62-955 - 3" W  
Copper Glass

## FINISH OPTIONS



Brushed Nickel  
Clear Seeded Glass



Brushed Nickel  
Crackle Glass



Brushed Nickel  
White Opal Glass



Brushed Nickel  
Mirrored Glass



Brushed Nickel  
Copper Glass



# LINK

The Link is sleek and refined lighting ideal for any vanity or bathroom, adding interest with its modern style. Its simplistic design packs a punch of flair with its edgy styling.

## LED

ITEM	DESCRIPTION	FINISH	LIGHT SOURCE	WATTS	WIDTH	HEIGHT	EXT.	VOLTS	LUMENS	CRI	CERT. TYPE
62-2932	1 Lt. Pendant	Brushed Nickel w/ White Glass	LED	12W	2.75"	10.75"	•	120V	820	90	Damp
62-2934	1 Lt. Wall Sconce	Brushed Nickel w/ White Glass	LED	12W	4.5"	11.5"	3.75"	120V	820	90	Damp
62-2936	2 Lt. Vertical Wall Sconce	Brushed Nickel w/ White Glass	LED	12W	4.5"	21"	3.75"	120V	1640	90	Damp



Brushed Nickel 3 light canopy mounting plate (36" x 5.5"): 25-4091  
 Vertical Wall Fixture: CUL listed for horizontal or vertical installation  
 Sconce: CUL listed for up or down installation  
 Sconces are ADA compliant  
 Pendant: 12' of wire supplied

## INCANDESCENT

ITEM	DESCRIPTION	FINISH	NO. OF LIGHTS	LAMP TYPE	BASE	MAX WATTS	WIDTH	HEIGHT	EXT.	VOLTS	CERT. TYPE
60-2932	1 Lt. Pendant	Brushed Nickel w/ White Glass	1	T10	E26	60W	2.75"	10.75"	•	120V	Dry
60-2934	1 Lt. Wall Sconce	Brushed Nickel w/ White Glass	1	T10	E26	60W	4.5"	11.5"	3.75"	120V	Damp
60-2936	2 Lt. Vertical Wall Sconce	Brushed Nickel w/ White Glass	2	T10	E26	60W	4.5"	21"	3.75"	120V	Damp



62-2934 - 4.5" W



62-2936 - 4.5" W



62-2932 - 2.75" W



25-4091 - 36" L

## FINISH

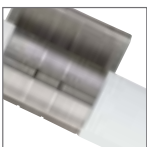

Brushed Nickel w/ White Glass

# FRAME LED

The Frame wall sconce features a minimal design with a large dose of contemporary styling. The overlapping rectangles add depth and visual interest, making it a wonderful addition to your homes lighting.

ITEM	DESCRIPTION	FINISH	LIGHT SOURCE	WATTS	LENGTH	WIDTH	HEIGHT	EXT.	VOLTS	CCT	LUMENS	CRI	CERT. TYPE
62-105	Sconce	Brushed Nickel	LED	10W	•	7.88"	20.25"	4"	120V	3000K	800	82	Damp
62-106	Pendant	Brushed Nickel	LED	10W	7.875"	3.81"	16.75"	•	120V	3000K	800	82	Damp
62-116	Island Pendant	Hazel Bronze	LED	39W	36"	4.13"	15.98"	•	120V	3000K	3315	82	Damp
62-125	Sconce	Hazel Bronze	LED	10W	•	7.88"	20.25"	4"	120V	3000K	285	82	Damp
62-126	Pendant	Hazel Bronze	LED	10W	7.875"	3.88"	16.75"	•	120V	3000K	800	82	Damp
62-136	Island Pendant	Brushed Nickel	LED	39W	36"	4.13"	15.98"	•	120V	3000K	3315	82	Damp



Additional Pendant Stems: Brushed Nickel (6") 25-2047, (12") 25-2021

Additional Pendant Stems: Hazel Bronze (6") 25-4121, (12") 25-4122

Sconces: ADA compliant

Pendants: 12' of wire supplied



62-125 - 8" W (shown)  
Hazel Bronze



62-106 - 6" W (shown)  
Brushed Nickel

## FINISH OPTIONS



Brushed Nickel



Hazel Bronze



62-136 - 36" L  
Brushed Nickel



62-116 - 36" L  
Hazel Bronze



# ALEXIS

Alexis pendants showcase a stylish and understated lighting solution for today's home. The focus on essential elements like style, design, and finish, all come together to create a sleek and uncluttered appearance. Alexis beautifully integrates into various decors and lighting solutions.

ITEM	DESCRIPTION	FINISH	NO. OF LIGHTS	LAMP TYPE	BASE	MAX WATTS	WIDTH	HEIGHT	VOLTS	CERT TYPE
60-7938	1 Lt. Lg. Pendant	Burnished Brass / Gold	1	A19	Med.	100W	15"	20.75"	120V	Dry
60-7939	1 Lt. Sm. Pendant	Burnished Brass / Gold	1	A19	Med.	100W	11"	17.13"	120V	Dry
60-7948	1 Lt. Lg. Pendant	Matte White	1	A19	Med.	100W	15"	20.75"	120V	Dry
60-7949	1 Lt. Sm. Pendant	Matte White	1	A19	Med.	100W	11"	17.13"	120V	Dry

Additional Burnished Brass Stems: (6") 25-468, (12") 25-469

Additional Matte White Stems: (6") 25-572, (12") 25-573

12' of wire supplied



60-7949 - 11" W (shown)  
Matte White



60-7938 - 15" W (shown)  
Burnished Brass

## FINISH OPTIONS

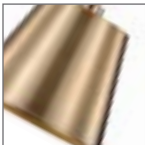

Burnished Brass  
Gold



Matte White



# MOTIF

The Motif is a one-light semi flush fixture that provides superior overhead illumination. The 9 inch height of the Motif allows it to be used as a traditional semi flush mount light over a sink or in a hallway. Several can be uniquely grouped in a series to define a space in the home.

ITEM	DESCRIPTION	FINISH	LAMP TYPE	MAX WATTS	WIDTH	HEIGHT	VOLTS	CRI	CERT TYPE
60-7321	1Lt. Semi-Flush	Brushed Brass w/ White Accents	A19	100W	7.25"	9"	120V	90	Dry
60-7322	1Lt. Semi-Flush	Brushed Brass w/ White Accents	A19	100W	10"	9"	120V	90	Dry
60-7323	1Lt. Semi-Flush	Brushed Brass w/ Smoked Glass Accents	A19	100W	7.25"	9"	120V	90	Dry
60-7324	1Lt. Semi-Flush	Brushed Brass w/ Smoked Glass Accents	A19	100W	10"	9"	120V	90	Dry
60-7331	1Lt. Semi-Flush	Black w/ Gold Accents	A19	100W	7.25"	9"	120V	90	Dry
60-7332	1Lt. Semi-Flush	Black w/ Gold Accents	A19	100W	10"	9"	120V	90	Dry
60-7333	1Lt. Semi-Flush	Black w/ Smoked Glass Accents	A19	100W	7.25"	9"	120V	90	Dry
60-7334	1Lt. Semi-Flush	Black w/ Smoked Glass Accents	A19	100W	10"	9"	120V	90	Dry

Pendants: 12' of Wire Supplied



60-7321 - 7" W (shown)  
Brushed Brass w/  
White Accents



60-7324 - 10" W (shown)  
Brushed Brass w/  
Smoked Glass Accents



60-7332 - 10" W (shown)  
Black w/  
Gold Accents

## FINISH OPTIONS



Brushed Brass w/  
White Accents



Brushed Brass w/  
Smoked Glass Accents



Black w/  
Gold Accents



Black w/ Smoked  
Glass Accents



60-7333 - 7" W (shown)  
Black w/ Smoked  
Glass Accents



# MARINA

The MARINA series is suited for a T9 nostalgic bulb. The clear glass shade is the perfect match for the clean lines of this minimalist design. When the design intent calls for uncluttered simplicity, the MARINA series units are just right.

ITEM	DESCRIPTION	FINISH	LAMP TYPE	WATTS	WIDTH	HEIGHT	EXT.	VOLTS	CRI	CERT TYPE
60-7140	1 Lt. Mini Pendant	Brushed Nickel w/ Clear Glass	T9	60W	4.75"	13.25"	•	120V	90	Dry
60-7141	1 Lt. Wall Sconce	Brushed Nickel w/ Clear Glass	T9	60W	4.75"	17.25"	5.25"	120V	90	Damp
60-7150	1 Lt. Mini Pendant	Brushed Brass w/ Clear Glass	T9	60W	4.75"	13.25"	•	120V	90	Dry
60-7151	1 Lt. Wall Sconce	Brushed Brass w/ Clear Glass	T9	60W	4.75"	17.25"	5.25"	120V	90	Damp
60-7160	1 Lt. Mini Pendant	Matte Black w/ Clear Glass	T9	60W	4.75"	13.25"	•	120V	90	Dry
60-7161	1 Lt. Wall Sconce	Matte Black w/ Clear Glass	T9	60W	4.75"	17.25"	5.25"	120V	90	Damp



Pendants: 9' of Wire Supplied



60-7141 - 5" W (shown)  
Brushed Nickel w/  
Clear Glass



60-7150 - 5" W (shown)  
Brushed Brass w/  
Clear Glass

## FINISH OPTIONS



Brushed Nickel w/  
Clear Glass

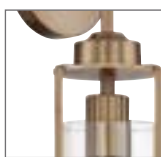

Brushed Brass w/  
Clear Glass



Matte Black w/  
Clear Glass



# BARRIQUE

The Barrique pendant embodies a quiet elegance, where simplicity meets warmth. With its soft honey-wood finish and delicate metal accents, it invites a touch of romance into any space.

ITEM	DESCRIPTION	FINISH	NO. OF LIGHTS	LAMP TYPE	BASE	MAX WATTS	WIDTH	HEIGHT	VOLTS	CERT. TYPE
60-6980	5 Lt. Pendant	Black/Honey Wood	5	A19	Med.	60W	24"	8.75"	120V	Dry

Additional Matte Black Stems: (6") 25-479, (12") 25-480  
 (2) x 6" Stems and (2) x 12" Stems Included  
 12' of Wire Supplied



60-6980 - 24" W

## FINISH



Black/Honey Wood



# ALTOS



The Altos Collection adds a touch of drama and intrigue to any space, effortlessly blending traditional with modern aesthetics. The meticulous attention to detail in the laser-cut shade and matching rivets provide Altos with its signature style and refined design.

## FINISH OPTIONS



Matte Black/  
Natural Brass



Matte Gray/ Matte  
Black



60-7851 - 18" W (shown)  
Matte Gray/ Matte Black

ITEM	DESCRIPTION	FINISH	NO. OF LIGHTS	LAMP TYPE	BASE	MAX WATTS	WIDTH	HEIGHT	VOLTS	CERT. TYPE
60-7840	3 Lt. Sm. Semi-Flush	Matte Black / Natural Brass	3	ST19	Med.	60W	14"	6.5"	120V	Damp
60-7841	4 Lt. Lg. Semi-Flush	Matte Black / Natural Brass	4	ST19	Med.	60W	18"	7"	120V	Damp
60-7842	3 Lt. Small Pendant	Matte Black / Natural Brass	3	A19	Med.	60W	14"	6.25"	120V	Damp
60-7843	4 Lt. Med. Pendant	Matte Black / Natural Brass	4	ST19	Med.	60W	18"	6.75"	120V	Damp
60-7844	5 Lt. Lg. Pendant	Matte Black / Natural Brass	5	ST19	Med.	60W	22"	7.38"	120V	Damp
60-7850	3 Lt. Sm. Semi-Flush	Matte Gray / Matte Black	3	ST19	Med.	60W	14"	6.5"	120V	Damp
60-7851	4 Lt. Lg. Semi-Flush	Matte Gray / Matte Black	4	ST19	Med.	60W	18"	7"	120V	Damp
60-7852	3 Lt. Sm. Pendant	Matte Gray / Matte Black	3	A19	Med.	60W	14"	6.25"	120V	Damp
60-7853	4 Lt. Med. Pendant	Matte Gray / Matte Black	4	ST19	Med.	60W	18"	6.75"	120V	Damp
60-7854	5 Lt. Lg. Pendant	Matte Gray / Matte Black	5	ST19	Med.	60W	22"	7.38"	120V	Damp

Additional Matte Black Stems: (6") 25-3041, (12") 25-3042  
 Additional Natural Brass Stems: (6") 25-6841, (12") 25-6842  
 (2) x 6" Stems and (2) x 12" Stems Included with Pendants  
 Pendants: 12' of Wire Supplied



60-7840 - 14" W (shown)  
 Matte Gray/ Natural Brass



60-7852 - 14" W (shown)  
 Matte Gray/ Matte Black



60-7843 - 18" W (shown)  
 Matte Gray/ Natural Brass



60-7854 - 22" W (shown)  
 Matte Gray/ Matte Black



# KETTLE

The Kettle collection captivates with its antique-like finish, embodying industrial elegance, creating a perfect balance to home decorative lighting. Bring a touch of nostalgic romance to your home with this charming and timeless design.

ITEM	DESCRIPTION	FINISH	NO. OF LIGHTS	LAMP TYPE	BASE	MAX WATTS	WIDTH	HEIGHT	EXT.	CERT. TYPE
60-5891	1 Lt. Sconce/Vanity	Weathered Brass	1	ST19*	Med.	60W	12"	8"	5"	Damp
60-5892	1 Lt. Mini Pendant	Weathered Brass	1	ST19*	Med.	60W	7.13"	7"	•	Dry
60-5893	3 Lt. Flush	Weathered Brass	3	ST19*	Med.	60W	16.88"	6"	•	Damp
60-5894	4 Lt. Pendant	Weathered Brass	4	ST19*	Med.	60W	20"	7.25"	•	Dry
60-5895	5 Lt. Oversized Pendant	Weathered Brass	5	ST19*	Med.	60W	30"	28"	•	Dry

Additional chain: (3') 25-5895

Additional Stems: (6") 25-5892, (12") 25-5893

(2) x 6" Stems and (2) x 12" Stems Included

60-5895: 12' of wire and 4' of chain supplied

Vintage Bulbs S2423 Included



60-5891- 12" W



60-5892- 7" W

## FINISH



Weathered Brass



60-5895- 30" W



60-5894- 20" W



60-5893- 17" W



\*ST19 Vintage lamps included



# COLONY

The Colony Collection showcases a refined blend of neutral, clean lines, making each piece a versatile choice for any space. Introduce a touch of elegance with the epitome of flexible style, effortlessly complementing any décor.



## FINISH OPTIONS



Matte White  
Burnished Brass



Matte Black  
Burnished Brass



Matte Black  
Polished Nickel

ITEM	DESCRIPTION	FINISH	NO. OF LIGHTS	LAMP TYPE	BASE	MAX WATTS	WIDTH	HEIGHT	VOLTS	CERT. TYPE
60-7480	1 Lt. Sm. Pendant	Matte White / Burnished Brass	1	A19	Med.	100W	15"	8.13"	120V	Dry
60-7481	1 Lt. Sm. Pendant	Matte Black / Burnished Brass	1	A19	Med.	100W	15"	8.13"	120V	Dry
60-7483	1 Lt. Med. Pendant	Matte White / Burnished Brass	1	A19	Med.	100W	19.88"	8.13"	120V	Dry
60-7484	1 Lt. Med. Pendant	Matte Black / Burnished Brass	1	A19	Med.	100W	19.88"	8.13"	120V	Dry
60-7486	1 Lt. Lg. Pendant	Matte White / Burnished Brass	1	A19	Med.	100W	24"	8.75"	120V	Dry
60-7487	1 Lt. Lg. Pendant	Matte Black / Burnished Brass	1	A19	Med.	100W	24"	8.75"	120V	Dry
60-7490	1 Lt. Sm. Semi-Flush	Matte White / Burnished Brass	1	A19	Med.	60W	15"	6.88"	120V	Dry
60-7491	1 Lt. Sm. Semi-Flush	Matte Black / Burnished Brass	1	A19	Med.	60W	15"	6.88"	120V	Dry
60-7493	1 Lt. Med. Semi-Flush	Matte White / Burnished Brass	1	A19	Med.	60W	19.88"	7"	120V	Dry
60-7494	1 Lt. Med. Semi-Flush	Matte Black / Burnished Brass	1	A19	Med.	60W	19.88"	7"	120V	Dry
60-7496	1 Lt. Lg. Semi-Flush	Matte White / Burnished Brass	1	A19	Med.	60W	24"	7.63"	120V	Dry
60-7497	1 Lt. Lg. Semi-Flush	Matte Black / Burnished Brass	1	A19	Med.	60W	24"	7.63"	120V	Dry
60-7482	1 Lt. Sm. Pendant	Matte Black / Polished Nickel	1	A19	Med.	100W	15"	8.13"	120V	Dry
60-7485	1 Lt. Med. Pendant	Matte Black / Polished Nickel	1	A19	Med.	100W	19.88"	8.13"	120V	Dry
60-7488	1 Lt. Lg. Pendant	Matte Black / Polished Nickel	1	A19	Med.	100W	24"	8.75"	120V	Dry
60-7492	1 Lt. Sm. Semi-Flush	Matte Black / Polished Nickel	1	A19	Med.	60W	15"	6.88"	120V	Dry
60-7495	1 Lt. Med. Semi-Flush	Matte Black / Polished Nickel	1	A19	Med.	60W	19.88"	7"	120V	Dry
60-7498	1 Lt. Lg. Semi-Flush	Matte Black / Polished Nickel	1	A19	Med.	60W	24"	7.63"	120V	Dry

Additional chain: (3') 25-467 Burnished Brass (3') 25-4141 Polished Nickel

Pendants: 12' of wire and 4' of chain supplied



60-7480 - 15" W (shown)  
Matte White  
Burnished Brass



60-7484 - 20" W (shown)  
Matte Black  
Burnished Brass



60-7488 - 24" W (shown)  
Matte Black  
Polished Nickel



60-7490 - 15" W (shown)  
Matte White  
Burnished Brass



60-7494 - 20" W (shown)  
Matte Black  
Burnished Brass



60-7498 - 24" W (shown)  
Matte Black  
Polished Nickel



# TANGO

The Tango wall light proves that simple style does not have to be boring. It features burnished brass accents on the backplate, cable cover, and fixture arm, which gives the design some pop. The matte black metal shade is laser-cut on its edge in a subtle wave pattern, adding a soft touch to its look. The wall sconce is ideal for lighting your bathroom, entryway, mudroom, or hallway. With Tango, the possibilities are endless.

## FINISH OPTIONS



Burnished Brass w/  
Matte Black



Burnished Brass w/  
Matte White



Polished Nickel w/  
Matte Black



60-7467 - 6" W (shown)  
Burnished Brass w/  
Matte Black

ITEM	DESCRIPTION	FINISH	NO. OF LIGHTS	LAMP TYPE	WATTS	WIDTH	HEIGHT	EXT.	CERT TYPE
60-7467	1Lt. Wall Sconce	Burnished Brass w/ Matte Black	1	A19	60W	6.25"	14"	10"	Damp
60-7468	1Lt. Wall Sconce	Burnished Brass w/ Matte White	1	A19	60W	6.25"	14"	10"	Damp
60-7469	1Lt. Wall Sconce	Polished Nickel / Matte Black	1	A19	60W	6.25"	14"	10"	Damp
60-7470	1Lt. Sm. Pendant	Burnished Brass w/ Matte Black	1	A19	60W	7.88"	16"	*	Dry
60-7471	1Lt. Sm. Pendant	Burnished Brass w/ Matte White	1	A19	60W	7.88"	16"	*	Dry
60-7472	1Lt. Sm. Pendant	Polished Nickel / Matte Black	1	A19	60W	7.88"	16"	*	Dry
60-7473	1Lt. Med. Pendant	Burnished Brass w/ Matte Black	1	A19	60W	12"	18.38"	*	Dry
60-7474	1Lt. Med. Pendant	Burnished Brass w/ Matte White	1	A19	60W	12"	18.38"	*	Dry
60-7475	1Lt. Med. Pendant	Polished Nickel / Matte Black	1	A19	60W	12"	18.38"	*	Dry
60-7476	1Lt. Lg. Pendant	Burnished Brass w/ Matte Black	1	A19	60W	15"	20.13"	*	Dry
60-7477	1Lt. Lg. Pendant	Burnished Brass w/ Matte White	1	A19	60W	15"	20.13"	*	Dry
60-7478	1Lt. Lg. Pendant	Polished Nickel / Matte Black	1	A19	60W	15"	20.13"	*	Dry

12' of wire supplied



60-7471 - 8" W (shown)  
Burnished Brass w/  
Matte White



60-7475 - 12" W (shown)  
Polished Nickel w/  
Matte Black



60-7478 - 15" W (shown)  
Polished Nickel w/  
Matte Black

# BELLCAP

Bellcap pendants are graceful, sculptural, and capture the inspiration of the Bauhaus design school, incorporating both simplicity and effectiveness. The geometric shape is well suited for function without compromising style.



ITEM	DESCRIPTION	FINISH	NO. OF LIGHTS	LAMP TYPE	BASE	MAX WATTS	WIDTH	HEIGHT	VOLTS	CERT. TYPE
60-7076	1Lt. Sm. Pendant	Burnished Brass	1	A19	Med.	60W	6.75"	13.25"	120V	Dry
60-7077	1Lt. Lg. Pendant	Burnished Brass	1	A19	Med.	100W	12"	16.38"	120V	Dry
60-7086	1Lt. Sm. Pendant	Matte Black	1	A19	Med.	60W	6.75"	13.25"	120V	Dry
60-7087	1Lt. Lg. Pendant	Matte Black	1	A19	Med.	100W	12"	16.38"	120V	Dry
60-7096	1Lt. Sm. Pendant	Matte White	1	A19	Med.	60W	6.75"	13.25"	120V	Dry
60-7097	1Lt. Lg. Pendant	Matte White	1	A19	Med.	100W	12"	16.38"	120V	Dry

12' of wire supplied



60-7096 - 7" W (shown)  
Matte White



60-7086 - 7" W (shown)  
Matte Black



60-7077 - 12" W (shown)  
Burnished Brass

## FINISH OPTIONS



Burnished Brass



Matte Black



Matte White



# LIGHTCAP

With its sleek silhouette and modern feel, Lightcap fits any contemporary or minimalist leaning home decor. It is ideal for kitchens, islands, dining rooms and bedrooms, is simplistic style with maximum design appeal.

ITEM	DESCRIPTION	FINISH	NO. OF LIGHTS	LAMP TYPE	BASE	MAX WATTS	WIDTH	HEIGHT	VOLTS	CERT. TYPE
60-7117	1 Lt. Sm. Pendant	Burnished Brass	1	A19	Med.	60W	7.75"	12.5"	120V	Dry
60-7118	1 Lt. Lg. Pendant	Burnished Brass	1	A19	Med.	100W	12"	14.5"	120V	Dry
60-7127	1 Lt. Sm. Pendant	Matte Black	1	A19	Med.	60W	7.75"	12.5"	120V	Dry
60-7128	1 Lt. Lg. Pendant	Matte Black	1	A19	Med.	100W	12"	14.5"	120V	Dry
60-7137	1 Lt. Sm. Pendant	Matte White	1	A19	Med.	60W	7.75"	12.5"	120V	Dry
60-7138	1 Lt. Lg. Pendant	Matte White	1	A19	Med.	100W	12"	14.5"	120V	Dry

12' of wire supplied



60-7117 - 8" W (shown)  
Burnished Brass



60-7127 - 8" W (shown)  
Matte Black



60-7138 - 12" W (shown)  
Matte White

## FINISH OPTIONS



Burnished Brass



Matte Black



Matte White



# ADINA



A stunning collection that blends contemporary style with streamlined design elements, Adina is effortless lighting at it's finest. A versatile collection with a minimalist appeal, making this series a great choice for those who want to create a modern and understated look in their home decor.

ITEM	DESCRIPTION	FINISH	NO. OF LIGHTS	LAMP TYPE	BASE	MAX WATTS	WIDTH	HEIGHT	VOLTS	CERT. TYPE
60-7766	1 Lt. Med. Pendant	Matte Black / Natural Brass	1	A19	Med.	60W	12.75"	13.75"	120V	Damp
60-7776	1 Lt. Med. Pendant	Natural Brass	1	A19	Med.	60W	12.75"	13.75"	120V	Damp
60-7767	1 Lt. Sm. Pendant	Matte Black / Natural Brass	1	A19	Med.	60W	10"	12.5"	120V	Damp
60-7777	1 Lt. Sm. Pendant	Natural Brass	1	A19	Med.	60W	10"	12.5"	120V	Damp
60-7768	3 Lt. Lg. Pendant	Matte Black / Natural Brass	3	A19	Med.	60W	18"	17.25"	120V	Damp
60-7778	3 Lt. Lg. Pendant	Natural Brass	3	A19	Med.	60W	18"	17.25"	120V	Damp

Additional Stems: (6") 25-6841, (12") 25-6841  
 (2) x 6" Stems and (2) x 12" Stems Included  
 12' of Wire Supplied



60-7777 - 10" W (shown)  
Natural Brass



60-7766- 13" W (shown)  
Matte Black/  
Natural Brass



60-7778 - 18" W (shown)  
Natural Brass

## FINISH OPTIONS



Natural Brass



Matte Black/  
Natural Brass



# OUTPOST

Open, airy and full of charm, the Outpost collection features unique style that is all its own. Applications are boundless, with the ability to illuminate a variety of areas in your home.

ITEM	DESCRIPTION	FINISH	NO. OF LIGHTS	LAMP TYPE	BASE	MAX WATTS	WIDTH	HEIGHT	EXT.	VOLTS	CERT. TYPE
60-7519	1Lt. Sconce/Vanity	Matte Black / Burnished Brass	1	T9	Med.	60W	7"	9.75"	7.75"	120V	Damp
60-7520	1Lt. Sconce/Vanity	Matte White / Burnished Brass	1	T9	Med.	60W	7"	9.75"	7.75"	120V	Damp
60-7521	1Lt. Sm. Pendant	Matte Black / Burnished Brass	1	T9	Med.	60W	9.5"	9.75"	•	120V	Dry
60-7522	1Lt. Sm. Pendant	Matte White / Burnished Brass	1	T9	Med.	60W	9.5"	9.75"	•	120V	Dry
60-7523	1Lt. Med. Pendant	Matte Black / Burnished Brass	1	T9	Med.	60W	13"	10.63"	•	120V	Dry
60-7524	1Lt. Med. Pendant	Matte White / Burnished Brass	1	T9	Med.	60W	13"	10.63"	•	120V	Dry
60-7525	1Lt. Lg. Pendant	Matte Black / Burnished Brass	1	T9	Med.	60W	16.5"	11.63"	•	120V	Dry
60-7526	1Lt. Lg. Pendant	Matte White / Burnished Brass	1	T9	Med.	60W	16.5"	11.63"	•	120V	Dry

Additional chain: (3') 25-467

Sconce/Vanities: cULus listed for up or down installation

Pendants: 12' of wire and 4' of chain supplied



60-7520 - 7" W (shown)

Matte White /  
Burnished Brass



60-7525- 17" W (shown)

Matte Black /  
Burnished Brass



60-7521 - 10" W (shown)

Matte Black /  
Burnished Brass

## FINISH OPTIONS



Matte White /  
Burnished Brass



Matte Black /  
Burnished Brass



# COLLINS

Elevate your space with the timeless allure of Collins, a lighting ensemble that transcends mere functionality, where sophistication meets warmth. This collection creates a symphony of light that mirrors the beauty of your home.

ITEM	DESCRIPTION	FINISH	NO. OF LIGHTS	LAMP TYPE	BASE	MAX WATTS	WIDTH	HEIGHT	EXT.	CERT TYPE
60-8001	8" Ceramic Flush Mount	Brushed Brass / Ceramic	1	A19	Medium	60W	7.5"	8.13"	120V	Damp
60-8002	8" Ceramic Mini Pendant	Brushed Brass / Ceramic	1	A19	Medium	60W	7.5"	6.25"	120V	Dry
60-8003	14" Ceramic Pendant	Brushed Brass / Ceramic	1	A19	Medium	60W	14"	10.5"	120V	Dry
60-8011	8" Ceramic Flush Mount	Matte Black / Ceramic	1	A19	Medium	60W	7.5"	8.13"	120V	Damp
60-8012	8" Ceramic Mini Pendant	Matte Black / Ceramic	1	A19	Medium	60W	7.5"	6.25"	120V	Dry
60-8013	14" Ceramic Pendant	Matte Black / Ceramic	1	A19	Medium	60W	14"	10.5"	120V	Dry

Additional Stems: Brushed Brass (6") 25-477, (12") 25-478, Matte Black (6") 25-479, (12") 25-480  
 (2) x 6" Stems and (2) x 12" Stems Included with Pendant  
 Pendants & Mini Pendants: 12' of Wire Supplied



60-8001 - 8" W (shown)  
 Brushed Brass/  
 Ceramic



60-8011 - 8" W (shown)  
 Matte Black/  
 Ceramic

## FINISH OPTIONS



Matte Black/  
 Ceramic



Brushed Brass/  
 Ceramic



60-8002 - 8" W (shown)  
Brushed Brass/  
Ceramic



60-8013 - 14" W (shown)  
Matte Black/  
Ceramic



# EVERTON

Modern illumination with beautiful, subtle details, elevates the Everton's group of pendants style to grand heights. Creating a wonderful balance of color's to choose from, make your home a haven with Everton, ideal for today's stylish luminaires.

ITEM	DESCRIPTION	FINISH	NO. OF LIGHTS	LAMP TYPE	BASE	MAX WATTS	WIDTH	HEIGHT	VOLTS	CERT. TYPE
60-7875	1 Lt. 10" Pendant	Matte Gray / Brass	1	A19	Med.	60W	10"	13.25"	120V	Dry
60-7876	1 Lt. 10" Pendant	Matte Black / Brass	1	A19	Med.	60W	10"	13.25"	120V	Dry
60-7877	2 Lt. 14" Pendant	Matte Gray / Brass	2	A19	Med.	60W	14"	18"	120V	Dry
60-7878	2 Lt. 14" Pendant	Matte Black / Brass	2	A19	Med.	60W	14"	18"	120V	Dry

Additional Stems: Natural Brass (6") 25-3086, (12") 25-3087

(2) x 6" Stems and (2) x 12" Stems Included with Pendant

Pendants: 12' of Wire Supplied



60-7875 - 10" W (shown)  
Matte Gray / Brass



60-7878 - 14" W (shown)  
Matte Black / Brass

## FINISH OPTIONS



Matte Gray / Brass

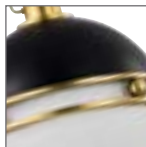

Matte Black / Brass



# LAKESHORE

Unleash the transformative power of romance with the Lakeshore collection, creating an atmosphere where warmth and style converge. These fixtures will set the perfect mood for any occasion, from cozy nights to elegant gatherings. A testament to the enduring allure of true, and exquisite design.

ITEM	DESCRIPTION	FINISH	NO. OF LIGHTS	LAMP TYPE	BASE	MAX WATTS	WIDTH	HEIGHT	VOLTS	CERT. TYPE
60-7770	1 Lt. Flush Mount	Matte Black/White Opal Glass	1	ST19	Med.	60W	10"	9.13"	120V	Damp
60-7771	1 Lt. Flush Mount	Matte Black/White Opal Glass	1	ST19	Med.	60W	13"	11.88"	120V	Damp
60-7772	1 Lt. Flush Mount	Matte Black/White Opal Glass	1	ST19	Med.	60W	18"	15.63"	120V	Damp
60-7773	1 Lt. Sm. Pendant	Matte Black/White Opal Glass	1	ST19	Med.	60W	10"	8.88"	120V	Damp
60-7774	1 Lt. Med. Pendant	Matte Black/White Opal Glass	1	ST19	Med.	60W	13"	11.63"	120V	Damp
60-7775	1 Lt. Lg. Pendant	Matte Black/White Opal Glass	1	ST19	Med.	60W	18"	14.88"	120V	Damp
60-7780	1 Lt. Flush Mount	Natural Brass/White Opal Glass	1	ST19	Med.	60W	10"	9.13"	120V	Damp
60-7781	1 Lt. Flush Mount	Natural Brass/White Opal Glass	1	ST19	Med.	60W	13"	11.88"	120V	Damp
60-7782	1 Lt. Flush mount	Natural Brass/White Opal Glass	1	ST19	Med.	60W	18"	15.63"	120V	Damp
60-7783	1 Lt. Sm. Pendant	Natural Brass/White Opal Glass	1	ST19	Med.	60W	10"	8.88"	120V	Damp
60-7784	1 Lt. Med. Pendant	Natural Brass/White Opal Glass	1	ST19	Med.	60W	13"	11.63"	120V	Damp
60-7785	1 Lt. Lg. Pendant	Natural Brass/White Opal Glass	1	ST19	Med.	60W	18"	14.88"	120V	Damp

Additional Stems: Matte Black (6") 25-6135, (12") 25-6136/Natural Brass (6") 25-6841, (12") 25-6842  
 (2) x 6" Stems and (2) x 12" Stems Included with Pendant  
 Pendants: 12' of Wire Supplied



60-7780 - 10" W (shown)  
 Natural Brass



60-7774 - 13" W (shown)  
 Matte Black

## FINISH OPTIONS



Natural Brass  
 White Opal Glass

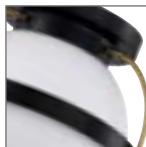

Matte Black  
 White Opal Glass



# LAFAYETTE

The Lafayette collection is a beautiful set of transitional-style lighting fixtures that combine elements of both traditional and contemporary styles with clean lines and a simple shape. Whether you're looking to update your dining room, living room, or bedroom, the Lafayette collection is a great choice.

ITEM	DESCRIPTION	FINISH	NO. OF LIGHTS	LAMP TYPE	BASE	MAX WATTS	WIDTH	HEIGHT	VOLTS	CERT. TYPE
60-7905	1 Lt. 14" Flush Mount	Matte Black Natural Brass / White Opal Glass	1	A19	Med.	60W	14"	8.13"	120V	Damp
60-7906	3 Lt. 18" Flush Mount	Matte Black Natural Brass / White Opal Glass	3	A19	Med.	60W	18"	10.13"	120V	Damp
60-7907	1 Lt. 14" Pendant	Matte Black Natural Brass / White Opal Glass	1	A19	Med.	60W	14"	9.13"	120V	Damp
60-7908	3 Lt. 18" Pendant	Matte Black Natural Brass / White Opal Glass	3	A19	Med.	60W	18"	11.25"	120V	Damp
60-7915	1 Lt. 14" Flush Mount	Matte Gray Natural Brass / White Opal Glass	1	A19	Med.	60W	14"	8.13"	120V	Damp
60-7916	3 Lt. 18" Flush Mount	Matte Gray Natural Brass / White Opal Glass	3	A19	Med.	60W	18"	10.13"	120V	Damp
60-7917	1 Lt. 14" Pendant	Matte Gray Natural Brass / White Opal Glass	1	A19	Med.	60W	14"	9.13"	120V	Damp
60-7918	3 Lt. 18" Pendant	Matte Gray Natural Brass / White Opal Glass	3	A19	Med.	60W	18"	11.25"	120V	Damp

Additional Stems: Natural Brass (6") 25-6841, (12") 25-6842  
 (2) x 6" Stems and (2) x 12" Stems Included with Pendant  
 Pendants: 12' of Wire Supplied



60-7915 - 14" W (shown)  
Matte Gray



60-7907 - 14" W (shown)  
Matte Black

## FINISH OPTIONS

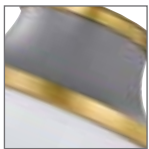

Matte Gray  
Natural Brass /  
White Opal Glass



Matte Black  
Natural Brass /  
White Opal Glass



# VALDORA

Evoke a sense of tranquility with the Valdora Collection, which pays homage to classic, luminous illumination. Transform the rooms in your home with harmonious fixtures, paying homage to traditional style but designed for today's style.

ITEM	DESCRIPTION	FINISH	NO. OF LIGHTS	LAMP TYPE	BASE	MAX WATTS	WIDTH	HEIGHT	VOLTS	CERT. TYPE
60-7860	1 Lt. 10" Flush Mount	Natural Brass / White Opal Glass	1	A19	Med.	60W	10.38"	9"	120V	Damp
60-7861	1 Lt. 14" Flush Mount	Natural Brass / White Opal Glass	1	A19	Med.	60W	14"	12.5"	120V	Damp
60-7862	1 Lt. 10" Pendant	Natural Brass / White Opal Glass	1	A19	Med.	60W	10.38"	11"	120V	Damp
60-7863	1 Lt. 14" Pendant	Natural Brass / White Opal Glass	1	A19	Med.	60W	14"	14.88"	120V	Damp
60-7870	1 Lt. 10" Flush Mount	Polished Nickel / White Opal Glass	1	A19	Med.	60W	10.38"	9"	120V	Damp
60-7871	1 Lt. 14" Flush Mount	Polished Nickel / White Opal Glass	1	A19	Med.	60W	14"	12.5"	120V	Damp
60-7872	1 Lt. 10" Pendant	Polished Nickel / White Opal Glass	1	A19	Med.	60W	10.38"	11"	120V	Damp
60-7873	1 Lt. 14" Pendant	Polished Nickel / White Opal Glass	1	A19	Med.	60W	14"	14.88"	120V	Damp

Additional Stems: Natural Brass (6") 25-6841, (12") 25-6842  
 (2) x 6" Stems and (2) x 12" Stems Included with Pendant  
 Pendants: 12' of Wire Supplied



60-7870 - 10" W (shown)  
 Polished Nickel  
 White opal Glass



60-7863 - 14" W (shown)  
 Natural Brass  
 White Opal Glass

## FINISH OPTIONS



Natural Brass  
 White Opal Glass



Polished Nickel  
 White Opal Glass



# ADMIRAL

A modern collection with a twist, the Admiral series features a dual finish, unique design, and a fashionable statement for home luminaires. A beautiful design that is versatile and will compliment a variety of home decors.

ITEM	DESCRIPTION	FINISH	NO. OF LIGHTS	LAMP TYPE	BASE	MAX WATTS	WIDTH	HEIGHT	EXT.	CERT. TYPE
60-7901	1 Lt. Wall Sconce	Matte Black Natural Brass/White Opal Glass	1	A19	Med.	60W	6.5"	15.38"	6.63"	Damp
60-7902	1 Lt. 7" Pendant	Matte Black Natural Brass/White Opal Glass	1	A19	Med.	60W	6.5"	14"	•	Damp
60-7903	1 Lt. 10" Pendant	Matte Black Natural Brass/White Opal Glass	1	A19	Med.	60W	10"	21.5"	•	Damp
60-7911	1 Lt. Wall Sconce	Matte Black Brushed Nickel/White Opal Glass	1	A19	Med.	60W	6.5"	15.38"	6.63"	Damp
60-7912	1 Lt. 7" Pendant	Matte Black Brushed Nickel/White Opal Glass	1	A19	Med.	60W	6.5"	14"	•	Damp
60-7913	1 Lt. 10" Pendant	Matte Black Brushed Nickel/White Opal Glass	1	A19	Med.	60W	10"	21.5"	•	Damp
60-7921	1 Lt. Wall Sconce	Matte White Natural Brass/White Opal Glass	1	A19	Med.	60W	6.5"	15.38"	6.63"	Damp
60-7922	1 Lt. 7" Pendant	Matte White Natural Brass/White Opal Glass	1	A19	Med.	60W	6.5"	14"	•	Damp
60-7923	1 Lt. 10" Pendant	Matte White Natural Brass/White Opal Glass	1	A19	Med.	60W	10"	21.5"	•	Damp

Additional Stems: Brushed Nickel (6") 25-2057, (12") 25-2055/Natural Brass (6") 25-6841, (12") 25-6842  
 (2) x 6" Stems and (2) x 12" Stems Included with Pendant

Pendants: 12' of Wire Supplied



60-7901 - 7" W (shown)

Matte Black & Natural Brass / White Opal Glass



60-7923 - 10" W (shown)

Matte White & Natural Brass / White Opal Glass

## FINISH OPTIONS



Matte Black Natural Brass / White Opal Glass



Matte Black Brushed Nickel / White Opal Glass

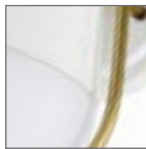

Matte White Natural Brass / White Opal Glass



# PERKINS

The simplistic design of Perkins is understated, yet elegant. Perfect for updating outdated lighting in a bathroom or adding illumination to an entryway. With a variety of options, use Perkins to bring your home's decor to light.

ITEM	DESCRIPTION	FINISH	NO. OF LIGHTS	LAMP TYPE	BASE	MAX WATTS	WIDTH	HEIGHT	EXT.	CERT. TYPE
60-7458	1 Lt. Sconce/Vanity	Matte Black w/ Burnished Brass	1	A19	Med.	60W	7"	11.13"	7.88"	Damp
60-7459	1 Lt. Sconce/Vanity	Matte White w/ Burnished Brass	1	A19	Med.	60W	7"	11.13"	7.88"	Damp
60-7460	1 Lt. Sm. Pendant	Matte Black w/ Burnished Brass	1	A19	Med.	100W	15"	7.25"	•	Dry
60-7461	1 Lt. Med. Pendant	Matte Black w/ Burnished Brass	1	A19	Med.	100W	19.63"	7.5"	•	Dry
60-7462	1 Lt. Lg. Pendant	Matte Black w/ Burnished Brass	1	A19	Med.	100W	24"	7.5"	•	Dry
60-7463	1 Lt. Sm. Pendant	Matte White w/ Burnished Brass	1	A19	Med.	100W	15"	7.25"	•	Dry
60-7464	1 Lt. Med. Pendant	Matte White w/ Burnished Brass	1	A19	Med.	100W	19.63"	7.5"	•	Dry
60-7465	1 Lt. Lg. Pendant	Matte White w/ Burnished Brass	1	A19	Med.	100W	24"	7.5"	•	Dry

Additional Stems: (6") 25-468, (12") 25-469

(2) x 6" Stems and (2) x 12" Stems Included

Sconce/Vanities: CUL listed for up or down installation

Pendants: 12' of wire supplied



60-7458 - 7" W (shown)  
Matte Black /  
Burnished Brass



60-7460 - 15" W (shown)  
Matte Black /  
Burnished Brass



60-7465 - 24" W (shown)  
Matte White /  
Burnished Brass

## FINISH OPTIONS



Matte White w/  
Burnished Brass



Matte Black /  
Burnished Brass



# DOVER

The Dover collection offers a perfect balance of grace and subtle detailing, making it ideal for versatile lighting solutions. Adding a timeless appeal to any space, this functional yet stylish lighting brings a sophisticated touch to your home.

ITEM	DESCRIPTION	FINISH	NO. OF LIGHTS	LAMP TYPE	BASE	MAX WATTS	WIDTH	HEIGHT	EXT.	CERT TYPE
60-7408	1 Lt. Mini Pendant	Black w/ Vintage Brass	1	A19	Med.	60W	7"	9.5"	•	Dry
60-7409	1 Lt. Mini Pendant	White w/ Vintage Brass	1	A19	Med.	60W	7"	9.5"	•	Dry
60-7410	1 Lt. Mini Pendant	Clear Glass w/ Vintage Brass	1	A19	Med.	60W	7"	9.5"	•	Dry
60-7411	1 Lt. Med. Pendant	Black w/ Vintage Brass	1	A19	Med.	60W	13.75"	10"	•	Dry
60-7412	1 Lt. Med. Pendant	White w/ Vintage Brass	1	A19	Med.	60W	13.75"	10"	•	Dry
60-7413	1 Lt. Med. Pendant	Clear Glass w/ Vintage Brass	1	A19	Med.	60W	13.75"	10"	•	Dry
60-7414	3 Lt. Lg. Pendant	Black w/ Vintage Brass	3	A19	Med.	60W	20"	13.75"	•	Dry
60-7415	3 Lt. Lg. Pendant	White w/ Vintage Brass	3	A19	Med.	60W	20"	13.75"	•	Dry
60-7416	3 Lt. Lg. Pendant	Clear Glass w/ Vintage Brass	3	A19	Med.	60W	20"	13.75"	•	Dry
60-7445	1 Lt. Sconce/Vanity	Black w/ Vintage Brass	1	A19	Med.	60W	7"	19"	9.25"	Damp
60-7446	1 Lt. Sconce/Vanity	White w/ Vintage Brass	1	A19	Med.	60W	7"	19"	9.25"	Damp
60-7449	1 Lt. Sconce/Vanity	Clear Glass w/ Vintage Brass	1	A19	Med.	60W	7"	19"	9.25"	Damp
60-7417	3 Lt. Med. Flush	Black w/ Vintage Brass	3	A19	Med.	60W	13.75"	8.25"	•	Dry
60-7418	3 Lt. Med. Flush	White w/ Vintage Brass	3	A19	Med.	60W	13.75"	8.25"	•	Dry
60-7419	3 Lt. Med. Flush	Clear Glass w/ Vintage Brass	3	A19	Med.	60W	13.75"	8.25"	•	Dry
60-7420	3 Lt. Lg. Flush	Black w/ Vintage Brass	3	A19	Med.	60W	20"	8.75"	•	Dry
60-7421	3 Lt. Lg. Flush	White w/ Vintage Brass	3	A19	Med.	60W	20"	8.75"	•	Dry
60-7422	3 Lt. Lg. Flush	Clear Glass w/ Vintage Brass	3	A19	Med.	60W	20"	8.75"	•	Dry

Additional Stems: (6") 25-3086, (12") 25-3087

(2) x 6" Stems and (2) x 12" Stems Included with Pendants

Pendants: 12' of wire supplied



60-7445 - 7" W (shown)

Black w/  
Vintage Brass

## FINISH OPTIONS

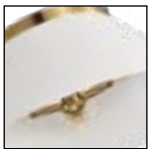

White w/  
Vintage Brass



Black w/  
Vintage Brass



Clear Glass w/  
Vintage Brass



60-7418 - 14" W (shown)  
White w/  
Vintage Brass



60-7422 - 20" W (shown)  
Clear Glass w/  
Vintage Brass



60-7415 - 20" W (shown)  
White w/  
Vintage Brass



60-7410 - 7" W (shown)  
Clear Glass w/  
Vintage Brass



60-7413 - 14" W (shown)  
Clear Glass w/  
Vintage Brass



# BRIDGEVIEW

The Bridgeview Collection is designed with modest details yet is stylish to a fault. A refined style featuring an aged look provides the finishing touch to this tasteful collection.

ITEM	DESCRIPTION	FINISH	NO. OF LIGHTS	LAMP TYPE	BASE	MAX WATTS	LENGTH	WIDTH	HEIGHT	EXT.	CERT. TYPE
60-1703	2 Lt. Island Pendant	Mission Dust Bronze	2	A19	Med.	150W	40"	16"	28"	•	Dry
60-1707	1 Lt. Pendant	Mission Dust Bronze	1	A19	Med.	150W	•	16"	15"	•	Dry
60-1708	1 Lt. Mini Pendant	Mission Dust Bronze	1	A19	Med.	100W	•	8.5"	6.5"	•	Dry
60-1709	1 Lt. Sconce	Mission Dust Bronze	1	A19	Med.	100W	•	8.5"	7.25"	10"	Damp
60-1711	2 Lt. Sconce	Mission Dust Bronze	2	A19	Med.	100W	•	20"	7.25"	10"	Damp

Additional chain: (3') 25-3021

Additional Stems: (6") 25-4001, (12") 25-4002

(2) x 6" Stems and (2) x 12" Stems Included

Sconces: CUL listed for up or down installation

Pendants: 12' of wire supplied

Island Pendant: 12' of wire and 4' of chain supplied



60-1709 - 9" W



60-1711 - 20" W

## FINISH



Mission Dust Bronze



60-1703 - 40" L



60-1707 - 16" W



60-1708- 9" W



# ALONDRA

The Alondra series is simplistic, graceful, yet striking in its design. A broad appeal that blends beautifully with existing décor, that does not need to be bold or brash to be the star of the show.

## FINISH OPTIONS

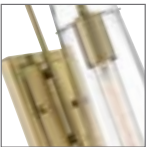

Vintage Brass w/ Clear Glass



Polished Nickel w/ Clear Glass

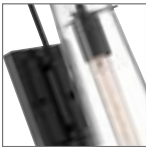

Black w/ Clear Glass

ITEM	DESCRIPTION	FINISH	NO. OF LIGHTS	LAMP TYPE	BASE	MAX WATTS	WIDTH	HEIGHT	EXT.	CERT. TYPE
60-6859	1Lt. Wall Sconce	Vintage Brass w/ Clear Glass	1	T9	Med.	60W	4.75"	17.25"	7"	Damp
60-6860	1Lt. Mini Pendant	Vintage Brass w/ Clear Glass	1	T9	Med.	60W	4"	14"	•	Dry
60-6869	1Lt. Wall Sconce	Polished Nickel w/ Clear Glass	1	A19	Med.	60W	4.75"	17.25"	7"	Damp
60-6870	1Lt. Mini Pendant	Polished Nickel w/ Clear Glass	1	A19	Med.	60W	4"	14"	•	Dry
60-6879	1Lt. Wall Sconce	Black w/ Clear Glass	1	A19	Med.	60W	4.75"	17.25"	7"	Damp
60-6880	1Lt. Mini Pendant	Black w/ Clear Glass	1	A19	Med.	60W	4"	14"	•	Dry

Additional Stems: Vintage Brass (6") 25-3086, (12") 25-3087  
 Additional Stems: Polished Nickel (6") 25-3088, (12") 25-3089  
 Additional Stems: Black (6") 25-485, (12") 25-486  
 (2) x 6" Stems and (2) x 12" Stems Included  
 Pendants: 12' of wire supplied



60-6859 - 5" W (shown)  
 Vintage Brass  
 w Clear Glass



60-6869 - 5" W (shown)  
 Polished Nickel  
 w/ Clear Glass



60-6880 - 4" W (shown)  
 Black w/  
 Clear Glass



# SPYGLASS

The crystal clear, waisted glass flute shade of the Spyglass series appears to float around the single light source. Its clean appearance is complemented by the various finishes, suitable for any transitional design. The width and height incorporate the glass, which is suspended by a three-point mount that extends from a round back plate and delicate hook.

ITEM	DESCRIPTION	FINISH	NO. OF LIGHTS	LAMP TYPE	BASE	MAX WATTS	WIDTH	HEIGHT	EXT.	CERT. TYPE
60-6855	1 Lt. Wall Sconce	Vintage Brass w/ Clear Glass	1	Type B	Cand.	60W	4.75"	16"	6.5"	Damp
60-6856	1 Lt. Mini Pendant	Vintage Brass w/ Clear Glass	1	Type B	Cand.	60W	4.75"	14"	•	Dry
60-6865	1 Lt. Wall Sconce	Polished Nickel w/ Clear Glass	1	Type B	Cand.	60W	4.75"	16"	6.5"	Damp
60-6866	1 Lt. Mini Pendant	Polished Nickel w/ Clear Glass	1	Type B	Cand.	60W	4.75"	14"	•	Dry
60-6875	1 Lt. Wall Sconce	Black w/ Clear Glass	1	Type B	Cand.	60W	4.75"	16"	6.5"	Damp
60-6876	1 Lt. Mini Pendant	Black w/ Clear Glass	1	Type B	Cand.	60W	4.75"	14"	•	Dry

Pendants: 12' of wire supplied



60-6865 - 5" W (shown)  
Polished Nickel  
w/ Clear Glass



60-6856 - 5" W (shown)  
Vintage Brass  
w Clear Glass

## FINISH OPTIONS

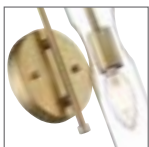

Vintage Brass  
w Clear Glass



Polished Nickel  
w/ Clear Glass



Black w/  
Clear Glass



# BEAKER

Nuvo's Beaker series is a sophisticated lighting solution for inside the home. Illuminate living rooms, dining rooms, hallways, and foyers, with these unique fixtures, featuring clear glass. Contemporary and elegant, the series is made of durable steel, and adds style to any home decor.

ITEM	DESCRIPTION	FINISH	NO. OF LIGHTS	LAMP TYPE	BASE	MAX WATTS	WIDTH	HEIGHT	EXT.	CERT. TYPE
60-5261	1 Lt. Wall Sconce	Brushed Nickel w/ Clear Glass	1	T9	Med.	60W	3.46"	14.09"	5"	Damp
60-5262	1 Lt. Mini Pendant	Brushed Nickel w/ Clear Glass	1	T9	Med.	60W	4.75"	14.5"	•	Dry
60-5263	2 Lt. Wall Sconce	Brushed Nickel w/ Clear Glass	2	T9	Med.	60W	23.75"	4.75"	5.88"	Damp
60-5361	1 Lt. Wall Sconce	Aged Bronze w/ Clear Glass	1	T9	Med.	60W	3.46"	14.09"	5"	Damp
60-5362	1 Lt. Mini Pendant	Aged Bronze w/ Clear Glass	1	T9	Med.	60W	4.75"	14.5"	•	Dry
60-5363	2 Lt. Wall Sconce	Aged Bronze w/ Clear Glass	2	T9	Med.	60W	23.75"	4.75"	5.88"	Damp

Additional Stems (Brushed Nickel): (6") 25-2057, (12") 25-2055,

Additional Stems (Aged Bronze): (6") 25-4066, (12") 25-4067.

Pendants and Trestle: 12' of wire supplied



60-5261 - 3" W (shown)  
Brushed Nickel  
w/ Clear Glass



60-5362- 5" W (shown)  
Aged Bronze w/  
Clear Glass



60-5363 - 24" W (shown)  
Aged Bronze

## FINISH OPTIONS



Brushed Nickel  
w/ Clear Glass



Aged Bronze w/  
Clear Glass



T9 Vintage  
lamps included



# BAHARI

The Bahari collection embodies simplicity and elegance with a touch of drama. It seamlessly complements a wide range of decor styles with its understated charm. Shine effortlessly without overpowering the room, Bahari makes a captivating focal point.

ITEM	DESCRIPTION	FINISH	NO. OF LIGHTS	LAMP TYPE	BASE	MAX WATTS	WIDTH	HEIGHT	EXT.	CERT. TYPE
60-6857	1 Lt. Wall Sconce	Vintage Brass w/ Clear Glass	1	T9	Med.	60W	4.75"	17.5"	7"	Damp
60-6858	1 Lt. Mini Pendant	Vintage Brass w/ Clear Glass	1	T9	Med.	60W	4"	14"	•	Dry
60-6867	1 Lt. Wall Sconce	Polished Nickel w/ Clear Glass	1	T9	Med.	60W	4.75"	17.5"	7"	Damp
60-6868	1 Lt. Mini Pendant	Polished Nickel /w Clear Glass	1	T9	Med.	60W	4"	14"	•	Dry
60-6877	1 Lt. Wall Sconce	Black w/ Clear Glass	1	T9	Med.	60W	4.75"	17.5"	7"	Damp
60-6878	1 Lt. Mini Pendant	Black w/ Clear Glass	1	T9	Med.	60W	4"	14"	•	Dry

Additional Stems: Vintage Brass (6") 25-3086, (12") 25-3087  
 Additional Stems: Polished Nickel (6") 25-3088, (12") 25-3089  
 Additional Stems: Black (6") 25-485, (12") 25-486  
 (2) x 6" Stems and (2) x 12" Stems Included  
 Pendants: 12' of wire supplied



60-6867 - 5" W (shown)  
 Polished Nickel  
 Clear Glass



60-6878 - 4" W (shown)  
 Black  
 Clear Glass

## FINISH OPTIONS

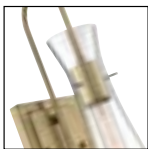

Vintage Brass  
 Clear Glass



Polished Nickel  
 Clear Glass



Black  
 Clear Glass



# TERESA

With its striking details, the Teresa pendants are beautiful luminaires that work with countless styles of home decor. Illuminating your spaces with clarity, grace, and elegance, these pendants are a resplendent addition to your lighting arrangement.

ITEM	DESCRIPTION	FINISH	NO. OF LIGHTS	LAMP TYPE	BASE	MAX WATTS	WIDTH	HEIGHT	CERT. TYPE
60-7142	1 Lt. Bell Pendant	Burnished Brass w/ Clear Glass	1	A19	Med.	100W	14"	16.5"	Dry
60-7143	1 Lt. Cylinder Pendant	Burnished Brass w/ Clear Glass	1	T9	Med.	60W	4.75"	19.75"	Dry
60-7152	1 Lt. Bell Pendant	Matte Black w/ Clear Glass	1	A19	Med.	100W	14"	16.5"	Dry
60-7153	1 Lt. Cylinder Pendant	Matte Black w/ Clear Glass	1	T9	Med.	60W	4.75"	19.75"	Dry

Additional Stems: Burnished Brass (6") 25-468, (12") 25-469

Additional Stems: Matte Black (6") 25-465, (12") 25-466

(2) x 6" Stems and (2) x 12" Stems Included

12' of wire supplied



60-7142 - 14" W (shown)  
Burnished Brass  
w/ Clear Glass



60-7153 - 5" W (shown)  
Matte Black  
w/ Clear Glass

## FINISH OPTIONS

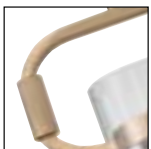

Burnished Brass  
w/ Clear Glass



Matte Black  
w/ Clear Glass

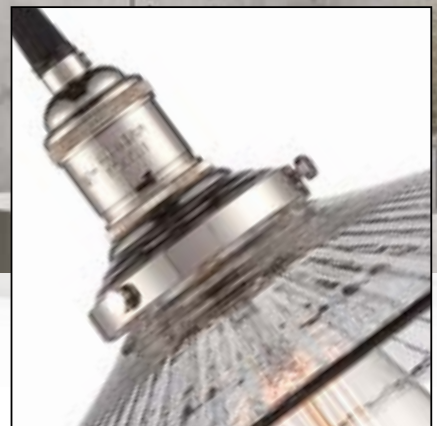

# VINTAGE

The Vintage wall sconces and pendants bring simplicity and form with their industrial-themed style. The shade features a minimal rim-like edge adding visual interest to the clear glass. The tooled knurling on the socket base is enhanced by the chic Polished Nickel finish. Bring new life to your bathroom's design with this series. "Edison-style" bulb is supplied with the fixture.

## FINISH OPTIONS



Polished Nickel w/  
Clear Glass



Polished Nickel w/  
Ribbed Glass



60-5415 - 5" W (shown)



60-5412 - 7" W (shown)

ITEM	DESCRIPTION	FINISH	NO. OF LIGHTS	LAMP TYPE	BASE	MAX WATTS	WIDTH	HEIGHT	EXT.	CERT. TYPE
* 60-5401	1 Lt. Caged Pendant	Polished Nickel	1	ST19	Med.	100W	7.38"	10.75"	•	Dry
60-5402	1 Lt. Pendant	Polished Nickel w/ Clear Glass	1	ST19	Med.	100W	6.5"	8.63"	•	Dry
60-5403	1 Lt. Pendant	Polished Nickel w/ Clear Glass	1	ST19	Med.	100W	7"	8.63"	•	Dry
60-5404	1 Lt. Pendant	Polished Nickel w/ Clear Glass	1	ST19	Med.	100W	5.13"	8.63"	•	Dry
* 60-5405	1 Lt. Pendant	Polished Nickel	1	ST19	Med.	100W	4.88"	8"	•	Dry
* 60-5406	1 Lt. Pendant	Polished Nickel	1	ST19	Med.	100W	14"	6.75"	•	Dry
60-5407	1 Lt. Pendant	Polished Nickel w/ Clear Glass	1	ST19	Med.	100W	14"	6.75"	•	Dry
60-5408	1 Lt. Pendant	Polished Nickel w/ Clear Glass	1	ST19	Med.	100W	14"	6.38"	•	Dry
* 60-5409	1 Lt. Pendant	Polished Nickel	1	ST19	Med.	100W	14"	6.5"	•	Dry
* 60-5411	1 Lt. Caged Pendant	Polished Nickel	1	ST19	Med.	100W	7.75"	8.25"	•	Dry
60-5412	1 Lt. Wall Sconce	Polished Nickel w/ Clear Glass	1	ST19	Med.	100W	6.5"	9.75"	7.63"	Damp
60-5413	1 Lt. Wall Sconce	Polished Nickel w/ Clear Glass	1	ST19	Med.	100W	7"	9.75"	7.88"	Damp
60-5414	1 Lt. Wall Sconce	Polished Nickel w/ Clear Glass	1	ST19	Med.	100W	5.13"	9.75"	6.13"	Damp
* 60-5415	1 Lt. Wall Sconce	Polished Nickel	1	ST19	Med.	100W	4.88"	9"	4.75"	Damp
60-5416	1 Lt. Pendant	Polished Nickel w/ Clear Ribbed Glass	1	ST19	Med.	100W	14"	6"	•	Dry

\* Glass not available or applicable

Pendants include 12' of black rayon cord

40W ST19 S2413 Vintage lamps included

Sconces are CUL listed for glass up or down installation



60-5402 - 7" (shown)



60-5411 - 8" W (shown)



60-5409 - 14" W (shown)



60-5404 - 5" W (shown)



60-5416 - 14" W (shown)



ST19 Vintage lamps included



# VINTAGE

The Vintage wall sconces and pendants bring simplicity and form with their industrial-themed style. The shade features a minimal rim-like edge adding visual interest to the clear glass. The tooled knurling on the socket base is enhanced by the chic Polished Nickel finish. Bring new life to your bathroom's design with this series. "Edison-style" bulb is supplied with the fixture.



## FINISH OPTIONS



Rustic Bronze w/  
Clear Glass



Rustic Bronze w/  
Ribbed Glass



60-5515 - 5" W (shown)



60-5513 - 7" W (shown)

ITEM	DESCRIPTION	FINISH	NO. OF LIGHTS	LAMP TYPE	BASE	MAX WATTS	WIDTH	HEIGHT	EXT.	CERT. TYPE
* 60-5501	1 Lt. Caged Pendant	Rustic Bronze	1	ST19	Med.	100W	7.38"	10.75"	•	Dry
60-5502	1 Lt. Pendant	Rustic Bronze w/ Clear Glass	1	ST19	Med.	100W	6.5"	8.63"	•	Dry
60-5503	1 Lt. Pendant	Rustic Bronze w/ Clear Glass	1	ST19	Med.	100W	7"	8.63"	•	Dry
60-5504	1 Lt. Pendant	Rustic Bronze w/ Clear Glass	1	ST19	Med.	100W	5.13"	8.63"	•	Dry
* 60-5505	1 Lt. Pendant	Rustic Bronze	1	ST19	Med.	100W	4.88"	8"	•	Dry
* 60-5506	1 Lt. Pendant	Rustic Bronze	1	ST19	Med.	100W	14"	6.75"	•	Dry
60-5507	1 Lt. Pendant	Rustic Bronze w/ Clear Glass	1	ST19	Med.	100W	14"	6.75"	•	Dry
60-5508	1 Lt. Pendant	Rustic Bronze w/ Clear Glass	1	ST19	Med.	100W	14"	6.38"	•	Dry
* 60-5509	1 Lt. Pendant	Rustic Bronze	1	ST19	Med.	100W	14"	6.5"	•	Dry
* 60-5511	1 Lt. Caged Pendant	Rustic Bronze	1	ST19	Med.	100W	7.75"	8.25"	•	Dry
60-5512	1 Lt. Wall Sconce	Rustic Bronze w/ Clear Glass	1	ST19	Med.	100W	6.5"	9.75"	7.63"	Damp
60-5513	1 Lt. Wall Sconce	Rustic Bronze w/ Clear Glass	1	ST19	Med.	100W	7"	9.75"	7.88"	Damp
60-5514	1 Lt. Wall Sconce	Rustic Bronze w/ Clear Glass	1	ST19	Med.	100W	5.13"	9.75"	6.13"	Damp
* 60-5515	1 Lt. Wall Sconce	Rustic Bronze	1	ST19	Med.	100W	4.88"	9"	4.75"	Damp
60-5516	1 Lt. Pendant	Rustic Bronze w/ Ribbed Glass	1	ST19	Med.	100W	14"	6"	•	Dry

\* Glass not available or applicable

Pendants include 12' of black rayon cord

40W ST19 S2413 Vintage lamps included

Sconces are CUL listed for glass up or down installation



60-5501 - 7" (shown)



60-5511 - 8" W (shown)



60-5506 - 14" W (shown)



60-5504 - 5" W (shown)



60-5516 - 14" W (shown)



ST19 Vintage lamps included



# AMADO

Elegant, transitional allure completes the Amado Collection, available in three beautiful finishes, encompassed in graceful lines to exude classic charm. Create a serene sanctuary in your bedroom or a captivating centerpiece in your dining room, experience illumination that redefines transitional design for today's home.

ITEM	DESCRIPTION	FINISH	NO. OF LIGHTS	LAMP TYPE	BASE	MAX WATTS	WIDTH	HEIGHT	CERT. TYPE
60-7815	1 Lt. 10" Pendant	Vintage Brass w/ Clear Glass	1	A19	Med.	60W	10"	16.5"	Dry
60-7816	1 Lt. 10" Pendant	Polished Nickel w/ Clear Glass	1	A19	Med.	60W	10"	16.5"	Dry
60-7817	1 Lt. 10" Pendant	Matte Black w/ Clear Glass	1	A19	Med.	60W	10"	16.5"	Dry
60-7818	3 Lt. 14" Pendant	Vintage Brass w/ Clear Glass	3	B11	Cand.	60W	14"	26.5"	Dry
60-7819	3 Lt. 14" Pendant	Polished Nickel w/ Clear Glass	3	B11	Cand.	60W	14"	26.5"	Dry
60-7820	3 Lt. 14" Pendant	Matte Black w/ Clear Glass	3	B11	Cand.	60W	14"	26.5"	Dry
60-7821	3 Lt. Semi-Flush	Vintage Brass w/ Clear Glass	3	B11	Cand.	60W	14"	14.25"	Dry
60-7822	3 Lt. Semi-Flush	Polished Nickel w/ Clear Glass	3	B11	Cand.	60W	14"	14.25"	Dry
60-7823	3 Lt. Semi-Flush	Matte Black w/ Clear Glass	3	B11	Cand.	60W	14"	14.25"	Dry

Additional chain: Vintage Brass (3') 25-484

Additional chain: Polished Nickel (3') 25-7815

Additional chain: Matte Black (3') 25-300

Pendants: 12' of wire and 4' of chain supplied



60-7821 - 14" W (shown)  
Vintage Brass w/  
Clear Glass



60-7817 - 10" W (shown)  
Matte Black w/  
Clear Glass

## FINISH OPTIONS



Vintage Brass w/  
Clear Glass



Polished Nickel w/  
Clear Glass



Matte Black w/  
Clear Glass



# BOLIVER

Step into a world of sophistication with the Boliver collection, adding the perfect touch of classic elegance. Expertly crafted, this series is a tribute to traditional, universal design. Let Boliver greet you with its charming and graceful beauty.

ITEM	DESCRIPTION	FINISH	NO. OF LIGHTS	LAMP TYPE	BASE	MAX WATTS	WIDTH	HEIGHT	CERT. TYPE
60-7800	3 Lt. 11" Pendant	Matte Black / Clear Seeded Glass	3	B11	Cand.	60W	11.75"	24"	Dry
60-7801	3 Lt. 11" Pendant	Vintage Brass / Clear Seeded Glass	3	B11	Cand.	60W	11.75"	24"	Dry
60-7802	3 Lt. 11" Pendant	Brushed Nickel / Clear Seeded Glass	3	B11	Cand.	60W	11.75"	24"	Dry
60-7803	3 Lt. 14" Pendant	Matte Black / Clear Seeded Glass	3	B11	Cand.	60W	14.13"	37.38"	Dry
60-7804	3 Lt. 14" Pendant	Vintage Brass / Clear Seeded Glass	3	B11	Cand.	60W	14.13"	37.38"	Dry
60-7805	3 Lt. 14" Pendant	Brushed Nickel / Clear Seeded Glass	3	B11	Cand.	60W	14.13"	37.38"	Dry
60-7806	3 Lt. Flush Mount	Matte Black / Clear Seeded Glass	3	B11	Cand.	60W	13.5"	9.5"	Dry
60-7807	3 Lt. Flush Mount	Vintage Brass / Clear Seeded Glass	3	B11	Cand.	60W	13.5"	9.5"	Dry
60-7808	3 Lt. Flush Mount	Brushed Nickel / Clear Seeded Glass	3	B11	Cand.	60W	13.5"	9.5"	Dry

Additional chain: Matte Black (3') 25-300

Additional chain: Vintage Brass (3') 25-484

Additional chain: Brushed Nickel (3') 25-1069

Pendants: 12' of wire and 4' of chain supplied



60-7807 - 14" W (shown)  
Vintage Brass w/  
Clear Glass



60-7805 - 14" W (shown)  
Brushed Nickel /  
Clear Seeded Glass

## FINISH OPTIONS



Matte Black  
Clear Seeded Glass



Vintage Brass /  
Clear Seeded Glass



Brushed Nickel /  
Clear Seeded Glass



# FARO

Faro is a streamlined, retro industrial design large one-light pendant that combines complementary finishes with vintage-styled prismatic glass. The Polished Nickel and Matte Black tones mimic a vintage fixture, while the clear prismatic glass diffuses the light that shines through. The Faro small pendant is 12.625 inches wide by 14.125 inches high, allowing it to stand alone or when several are grouped together makes an impactful design statement.

## FINISH OPTIONS



Burnished Brass w/  
Black Accents &  
Clear Prismatic  
Glass

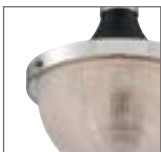

Polished Nickel w/  
Black Accents &  
Clear Prismatic  
Glass

ITEM	DESCRIPTION	FINISH	NO. OF LIGHTS	LAMP TYPE	BASE	MAX WATTS	WIDTH	HEIGHT	CERT. TYPE
60-7059	1 Lt. Sm. Pendant	Burnished Brass w/ Black Accents & Clear Prismatic Glass	1	A19	Med.	60"	10"	11.38"	Dry
60-7060	1 Lt. Lg. Pendant	Burnished Brass w/ Black Accents & Clear Prismatic Glass	1	A19	Med.	100"	12.63"	14.13"	Dry
60-7069	1 Lt. Sm. Pendant	Polished Nickel w/ Black Accents & Clear Prismatic Glass	1	A19	Med.	60"	10"	11.38"	Dry
60-7070	1 Lt. Lg. Pendant	Polished Nickel w/ Black Accents & Clear Prismatic Glass	1	A19	Med.	100"	12.63"	14.13"	Dry

Additional chain: Burnished Brass (3') 25-467

Additional chain: Polished Nickel (3') 25-4141

Pendants: 12' of wire and 4' of chain supplied



60-7059 - 10" W  
Burnished Brass



60-7060 - 13" W  
Burnished Brass



60-7069 - 10" W  
Polished Nickel



60-7070 - 13" W  
Polished Nickel



# BASEL

Our Basel pendants embody a romantic nod to timeless elegance with its classic schoolhouse design. Echoing the charm of historic lighting, these pendants add a touch of enduring sophistication to any space.

ITEM	DESCRIPTION	FINISH	NO. OF LIGHTS	LAMP TYPE	BASE	MAX WATTS	WIDTH	HEIGHT	CERT. TYPE
60-6757	1 Lt. Pendant	Burnished Brass w/ Clear Glass	1	A19	Med.	100W	13.75"	14.63"	Dry
60-6758	1 Lt. Pendant	Polished Nickel w/ Clear Glass	1	A19	Med.	100W	13.75"	14.63"	Dry
60-6759	1 Lt. Pendant	Aged Bronze w/ Clear Glass	1	A19	Med.	100W	13.75"	14.63"	Dry

Additional Stems: Burnished Brass: (6") 25-468, (12") 25-469

Additional Stems: Polished Nickel: (6") 25-418, (12") 25-419

Additional Stems: Aged Bronze: (6") 25-4066, (12") 25-4067

(2) x 6" Stems and (2) x 12" Stems Included

12' of wire supplied



60-6757 - 14" W  
Burnished Brass  
w/ Clear Glass



60-6758 - 14" W  
Polished Nickel  
w/ Clear Glass



60-6759 - 14" W  
Aged Bronze  
w/ Clear Glass

## FINISH OPTIONS



Burnished Brass  
w/ Clear Glass



Polished Nickel  
w/ Clear Glass



Aged Bronze  
w/ Clear Glass



# HARTLEY

The Hartley pendant offers a sophisticated take on the classic bottle-style fixture, blending modern design with a touch of vintage charm. Creating an inviting ambiance, it showcases its minimalist, timeless aesthetic, making it a perfect accent for any room.



ITEM	DESCRIPTION	FINISH	NO. OF LIGHTS	LAMP TYPE	BASE	MAX WATTS	WIDTH	HEIGHT	CERT. TYPE
60-6748	1 Lt. Pendant	Antique Copper w/ Clear Glass	1	A19	Med.	100W	6.5"	14.38"	Dry
60-6749	1 Lt. Pendant	Matte Black w/ Clear Glass	1	A19	Med.	100W	6.5"	14.38"	Dry

Additional chain: Antique Copper (3') 25-470

Additional chain: Matte Black (3') 25-475

12' of wire and 4' of chain supplied



60-6748 - 7" W  
Matte Black w/ Clear Glass



60-6749 - 7" W  
Antique Copper w/ Clear Glass

## FINISH OPTIONS



Antique Copper w/ Clear Glass



Matte Black w/ Clear Glass



# BRUGE

The Bruge pendant brings a touch of romance to any space, exuding timeless elegance with a modern twist. Designed to be as refined as it is striking, this pendant's graceful silhouette is perfect for those who seek lighting that feels both classic and enchanting.



ITEM	DESCRIPTION	FINISH	NO. OF LIGHTS	LAMP TYPE	BASE	MAX WATTS	WIDTH	HEIGHT	CERT. TYPE
60-6697	1 Lt. Pendant	Burnished Brass Clear Glass	1	A19	Med.	100W	10.5"	13"	Dry
60-6698	1 Lt. Pendant	Polished Nickel Clear Glass	1	A19	Med.	100W	10.5"	13"	Dry
60-6699	1 Lt. Pendant	Matte Black Clear Glass	1	A19	Med.	100W	10.5"	13"	Dry

Additional Stems Burnished Brass: (6") 25-468, (12") 25-469

Additional Stems Polished Nickel: (6") 25-418, (12") 25-419

Additional Stems Matte Black: (6") 25-465, (12") 25-466

(2) x 6" Stems and (2) x 12" Stems Included

12' of wire supplied



60-6697 - 10" W  
Burnished Brass



60-6698 - 10" W  
Polished Nickel



60-6699 - 10" W  
Matte Black

## FINISH OPTIONS



Burnished Brass  
Clear Glass



Polished Nickel  
Clear Glass



Matte Black  
Clear Glass



# ANTEBELLUM

The Antebellum pendants bring a modern twist to timeless jar designs, merging classic style with a fresh, transitional aesthetic. With a touch of vintage charm, they create a beautiful contrast with their warm and elegant design.

ITEM	DESCRIPTION	FINISH	NO. OF LIGHTS	LAMP TYPE	BASE	MAX WATTS	WIDTH	HEIGHT	CERT. TYPE
60-6731	1 Lt. Mini Pendant	Mahogany Bronze Clear Glass	1	A19	Med.	60W	5"	7.5"	Dry
60-6732	1 Lt. Mini Pendant	Matte Black Clear Glass	1	A19	Med.	60W	5"	7.5"	Dry
60-6733	1 Lt. Mini Pendant	Black / Aged Gold Clear Glass	1	A19	Med.	60W	5"	7.5"	Dry
60-6734	1 Lt. Mini Pendant	Polished Nickel Clear Glass	1	A19	Med.	60W	5"	7.5"	Dry
60-6735	1 Lt. Mini Pendant	Vintage Brass Clear Glass	1	A19	Med.	60W	5"	7.5"	Dry
60-6736	1 Lt. Mini Pendant	Brushed Nickel Clear Glass	1	A19	Med.	60W	5"	7.5"	Dry

12' cord supplied



60-6732 - 5" W (shown)  
Matte Black



60-6733 - 5" W (shown)  
Black / Aged Gold



60-6735 - 5" W (shown)  
Vintage Brass

## FINISH OPTIONS



Mahogany Bronze  
Clear Glass



Matte Black  
Clear Glass



Black / Aged Gold  
Clear Glass



Polished Nickel  
Clear Glass



Vintage Brass  
Clear Glass



Brushed Nickel  
Clear Glass



# ROSELLE

Revitalize your space with the Roselle Collection and let the allure of its design transcend the ordinary. Whether you're creating an inviting atmosphere, adding a touch of sophistication, or making a statement, this collection is designed for distinctive, yet flexible style.

## FINISH OPTIONS



Matte Black  
White Glass



Natural Brass  
White Glass



60-8042 - 24" W (shown)  
Natural Brass

ITEM	DESCRIPTION	FINISH	NO. OF LIGHTS	LAMP TYPE	BASE	MAX WATTS	WIDTH	HEIGHT	EXT.	CERT TYPE
60-8041	1 Lt. Vanity	Natural Brass White Glass	1	T9	Med.	60W	4.5"	13.75"	5.75"	Damp
60-8042	2 Lt. Vanity	Natural Brass White Glass	2	T9	Med.	60W	24"	4.5"	5.75"	Damp
60-8043	Mini Pendant	Natural Brass White Glass	1	T9	Med.	60W	3.75"	11.38"	•	Dry
60-8044	Flush Mount	Natural Brass White Glass	3	A19	Med.	60W	14.38"	6.5	•	Damp
60-8051	1 Lt. Vanity	Matte Black White Glass	1	T9	Med.	60W	4.5"	13.75"	5.75"	Damp
60-8052	2 Lt. Vanity	Matte Black White Glass	2	T9	Med.	60W	24"	4.5"	5.75"	Damp
60-8053	Mini Pendant	Matte Black White Glass	1	T9	Med.	60W	3.75"	11.38"	•	Dry
60-8054	Flush Mount	Matte Black White Glass	3	A19	Med.	60W	14.38"	6.5"	•	Damp

Additional Stems: Matte Black (6") 25-6135, (12") 25-6136, Natural Brass: (6") 25-6841, (12") 25-6842

(2) x 6" Stems and (2) x 12" Stems Included

Vanities (1 Light): CUL listed for up or down installation

Vanities (2 Light): CUL listed for horizontal or vertical installation

Mini Pendants: 12' of Wire Supplied



60-8041 - 14" Ht (shown)  
Natural Brass



60-8054 - 15" W (shown)  
Matte Black



60-8053 - 4" W (shown)  
Matte Black



# SKYLOFT

The Skyloft pendants exude an air of romance, captivating light in a way that feels both intimate and inviting. Bring warmth and elegance to any space, perfect for creating moments that feel beautifully timeless.

ITEM	DESCRIPTION	FINISH	NO. OF LIGHTS	LAMP TYPE	BASE	MAX WATTS	WIDTH	HEIGHT	CERT. TYPE
60-6671	1 Lt. Pendant	Burnished Brass w/ Clear Glass	1	A19	Med.	100W	9.88"	17.63"	Dry
60-6672	1 Lt. Pendant	Polished Nickel w/ Clear Glass	1	A19	Med.	100W	9.88"	17.63"	Dry
60-6673	1 Lt. Pendant	Aged Bronze w/ Clear Glass	1	A19	Med.	100W	9.88"	17.63"	Dry

Additional chain: Burnished Brass (3') 25-467

Additional chain: Polished Nickel (3') 25-4141

Additional chain: Aged Bronze (3') 25-4058

12' of wire and 4' of chain supplied



60-6671 - 10" W (shown)  
Burnished Brass  
w/ Clear Glass

## FINISH OPTIONS



Burnished Brass  
w/ Clear Glass



Polished Nickel  
w/ Clear Glass



Aged Bronze  
w/ Clear Glass



# SKY

The Sky series is a modern, asymmetrical design that is visually stimulating. The fresh, modern aesthetic will make it the centerpiece of home lighting, adding both function and artistic flair.

ITEM	DESCRIPTION	FINISH	NO. OF LIGHTS	LAMP TYPE	BASE	MAX WATTS	LENGTH	WIDTH	HEIGHT	CERT. TYPE
60-7124	3 Lt. Pendant	Burnished Brass w/ Clear Glass	3	B10	Cand.	60W	•	14.88"	22.38"	Dry
60-7125	6 Lt. Pendant	Burnished Brass w/ Clear Glass	6	B10	Cand.	60W	16"	31"	27.88"	Dry
60-7134	3 Lt. Pendant	Matte Black w/ Clear Glass	3	B10	Cand.	60W	•	14.88"	22.38"	Dry
60-7135	6 Lt. Pendant	Matte Black w/ Clear Glass	6	B10	Cand.	60W	16"	31"	27.88"	Dry

Additional Stems: Burnished Brass (6") 25-468, (12") 25-469

Additional Stems: Matte Black (6") 25-465, (12") 25-466

(2) x 6" Stems and (2) x 12" Stems Included

Pendants: 12' of wire supplied



60-7134 - 15" W (shown)  
Matte Black



60-7125 - 31" W (shown)  
Burnished Brass

## FINISH OPTIONS



Burnished Brass  
w/ Clear Glass



Matte Black  
w/ Clear Glass



# AXIS

The Axis collection showcases a transitional design with a stylish blend of finishes. With its minimalist charm, striking brass accent against a matte black backdrop, it is designed for maximum versatility. Axis embodies the essence of Mid-Century modern lighting.

ITEM	DESCRIPTION	FINISH	NO. OF LIGHTS	LAMP TYPE	BASE	MAX WATTS	WIDTH	HEIGHT	EXT.	CERT. TYPE
60-7121	1 Lt. Pendant	Matte Black w/ Burnished Brass Clear Glass	1	B10	Cand.	60W	7.75"	10.25"	•	Dry
60-7122	2 Lt. Sconce/Vanity	Matte Black w/ Burnished Brass Clear Glass	2	B10	Cand.	60W	5.88"	26.38"	7"	Damp
60-7123	3 Lt. Semi-Flush	Matte Black w/ Burnished Brass Clear Glass	3	B10	Cand.	60W	22.88"	10.75"	•	Dry
60-7126	6 Lt. Chandelier	Matte Black w/ Burnished Brass Clear Glass	6	B10	Cand.	60W	29.63"	5.88"	•	Dry
60-7131	1 Lt. Pendant	Matte Black w/ Brushed Nickel Clear Glass	1	B10	Cand.	60W	7.75"	10.25"	•	Dry
60-7132	2 Lt. Sconce/Vanity	Matte Black w/ Brushed Nickel Clear Glass	2	B10	Cand.	60W	5.88"	26.38"	7"	Damp
60-7133	3 Lt. Semi Flush	Matte Black w/ Brushed Nickel Clear Glass	3	B10	Cand.	60W	22.88"	10.75"	•	Dry
60-7136	6 Lt. Chandelier	Matte Black w/ Brushed Nickel Clear Glass	6	B10	Cand.	60W	29.63"	5.88"	•	Dry

Additional Stems: Matte Black (6") 25-465, (12") 25-466  
 (2) x 6" Stems and (2) x 12" Stems Included  
 Pendant conversion kit for semi flush: (Matte Black): 25-3032  
 Chandeliers, Semi flush and Pendants: 12' of wire supplied



60-7133 - 23" W (shown)  
Brushed Nickel



60-7132 - 6" W (shown)  
Brushed Nickel

## FINISH OPTIONS

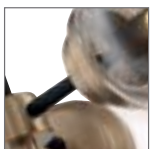

Matte Black w/  
Burnished Brass  
Clear Glass



Matte Black w/  
Brushed Nickel  
Clear Glass



60-7136 - 30" W (shown)  
Brushed Nickel



60-7121 - 8" W (shown)  
Burnished Brass



# RYDER

Who said lighting needs to be adorned and ornate? The Ryder collection is understated lighting for those whose tastes run more minimal than maximum. It offers a sleek, minimalist approach for those who crave simplicity.

ITEM	DESCRIPTION	FINISH	NO. OF LIGHTS	LAMP TYPE	BASE	MAX WATTS	WIDTH	HEIGHT	EXT.	CERT. TYPE
60-7341	1 Lt. Sconce/Vanity	Black w/ Brushed Brass	1	A19	Med.	60W	4.75"	6.38"	5.5"	Damp
60-7342	2 Lt. Vanity	Black w/ Brushed Brass	2	A19	Med.	60W	14.75"	4.75"	3.88"	Damp
60-7343	1 Lt. Semi-Flush	Black w/ Brushed Brass	1	A19	Med.	60W	4.75"	4.88"	•	Damp
60-7344	6 Lt. Chandelier	Black w/ Brushed Brass	6	A19	Med.	60W	25.25"	15"	•	Dry
60-7351	1 Lt. Sconce/Vanity	Black w/ Polished Nickel	1	A19	Med.	60W	4.75"	6.38"	5.5"	Damp
60-7352	2 Lt. Vanity	Black w/ Polished Nickel	2	A19	Med.	60W	14.75"	4.75"	3.88"	Damp
60-7353	1 Lt. Semi Flush	Black w/ Polished Nickel	1	A19	Med.	60W	4.75"	4.88"	•	Damp
60-7354	6 Lt. Chandelier	Black w/ Polished Nickel	6	A19	Med.	60W	25.25"	15"	•	Dry



60-7344 - 25" W (shown)  
Brushed Brass  
(adjustable arms)



60-7352 - 15" W (shown)  
Polished Nickel

Additional Stems: (Black) (6") 25-479, (12") 25-480  
Sconce/Vanities: CUL listed for up or down installation  
Vanities: CUL listed for horizontal or vertical installation  
Chandeliers: 12' of wire supplied

## FINISH OPTIONS



Black with  
Brushed Brass



Black with  
Polished Nickel



60-7341 - 5" W (shown)  
Brushed Brass



60-7353 - 5" W (shown)  
Polished Nickel

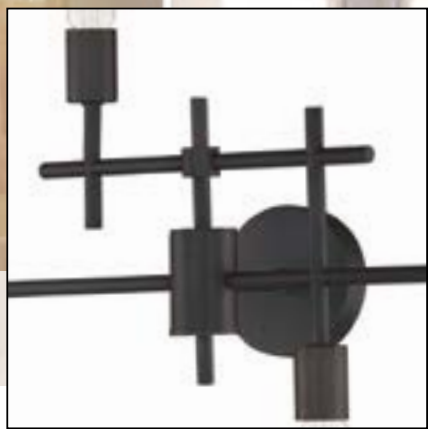

# DELPHI

The Delphi Vanity Light introduces a touch of avant-garde artistry with its striking, ultra-modern design. Sleek parallel lines and intersecting elements create a captivating visual, perfect for those who appreciate cutting-edge elegance.

ITEM	DESCRIPTION	FINISH	NO. OF LIGHTS	LAMP TYPE	BASE	MAX WATTS	LENGTH	WIDTH	HEIGHT	EXT.	CERT. TYPE
60-6861	4 Lt. Vanity	Black	4	G25	Med.	60W	•	22.52"	13.25"	6"	Damp
60-6862	8 Lt. Island Pendant	Black	8	G25	Med.	60W	45"	7"	19"	•	Dry
60-6871	4 Lt. Vanity	Aged Gold	4	G25	Med.	60W	•	22.52"	13.25"	6"	Damp
60-6872	8 Lt. Island Pendant	Aged Gold	8	G25	Med.	60W	45"	7"	19"	•	Dry

Additional Stems: Aged Gold (6") 25-487, (12") 25-488

Additional Stems: Black (6") 25-485, (12") 25-486

(2) x 6" Stems and (2) x 12" Stems Included

Vanities: CUL listed for horizontal or vertical installation

Pendants: 12' of wire supplied

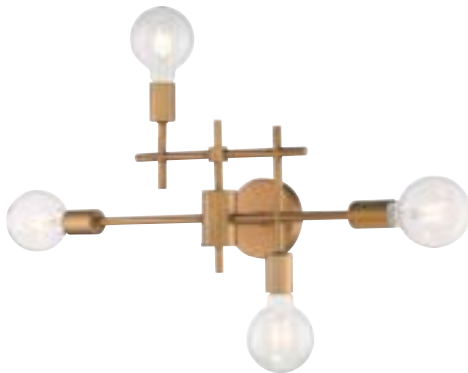

60-6871 - 23 W (shown)  
Aged Gold

## FINISH OPTIONS

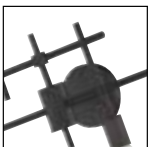

Black

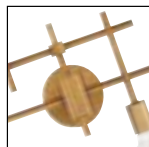

Aged Gold



60-6862- 45" L (shown)  
Black

# CIRRUS



Inspired by the Dawn of the Space Age, and the launch of the first satellite, the Cirrus series radiates charm with its striking starburst design. Emitting cosmic radiance, this unique and elegant piece will be a highlight for your home's lighting.

ITEM	DESCRIPTION	FINISH	NO. OF LIGHTS	LAMP TYPE	BASE	MAX WATTS	WIDTH	HEIGHT	CERT. TYPE
60-6991	6 Lt. Chandelier	Polished Nickel	6	B11	Cand.	60W	16"	16"	Dry
60-6992	6 Lt. Chandelier	Vintage Brass	6	B11	Cand.	60W	16"	16"	Dry
60-6993	8 Lt. Chandelier	Polished Nickel	8	B11	Cand.	60W	19.5"	19.5"	Dry
60-6994	8 Lt. Chandelier	Vintage Brass	8	B11	Cand.	60W	19.5"	19.5"	Dry

Additional chain: Polished Nickel (3') 25-490, Natural Brass (3') 25-484  
12' of wire and 4' of chain supplied



60-6991 - 16" W (shown)  
Polished Nickel



60-6994 - 20" W (shown)  
Vintage Brass

## FINISH OPTIONS

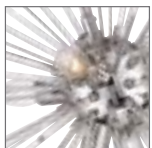

Polished Nickel



Vintage Brass



# SPIREFLY

The Spirefly pendant makes a bold statement, igniting the imagination with its striking design. This dynamic luminaire commands attention, blending industrial strength with artistic flair.

ITEM	DESCRIPTION	FINISH	NO. OF LIGHTS	LAMP TYPE	BASE	MAX WATTS	WIDTH	HEIGHT	CERT. TYPE
60-6730	6 Lt. Pendant	Matte Black w/ Burnished Brass	6	B11	Cand.	60W	17"	17.75"	Dry

Additional Stems: (6") 25-465, (12") 25-466  
 (2) x 6" Stems and (2) x 12" Stems Included  
 12' of wire supplied



60-6730 - 17" W

## FINISH



Matte Black w/  
Burnished Brass



# EMMA

A stylish lighting fixture that combines transitional elements with minimal design, Emma is a knockout. Versatility at its finest, either taking center stage as the focal point of a room's design or as a backdrop to suit any décor. Whichever space you choose, Emma is sure to be stunning.

## FINISH OPTIONS



Burnished Brass



Matte Black



Dark Bronze

ITEM	DESCRIPTION	FINISH	NO. OF LIGHTS	LAMP TYPE	BASE	MAX WATTS	WIDTH	HEIGHT	CERT TYPE
60-7931	4 Lt. Sm. Pendant	Burnished Brass	4	B11	Candelabra	60W	17"	24.13"	Dry
60-7932	4 Lt. Lg. Pendant	Burnished Brass	4	B11	Candelabra	60W	20"	26.5"	Dry
60-7941	4 Lt. Sm. Pendant	Matte Black	4	B11	Candelabra	60W	17"	24.13"	Dry
60-7942	4 Lt. Lg. Pendant	Matte Black	4	B11	Candelabra	60W	20"	26.5"	Dry
60-7951	4 Lt. Sm. Pendant	Dark Bronze	4	B11	Candelabra	60W	17"	24.13"	Dry
60-7952	4 Lt. Lg. Pendant	Dark Bronze	4	B11	Candelabra	60W	20"	26.5"	Dry

Additional Chain: Burnished Brass (3') 25-467, Matte Black (3') 25-475, Dark Bronze (3') 25-574  
 12' of wire and 4' of chain supplied



60-7931 - 17" W (shown)  
 Burnished Brass



60-7942 - 20" W (shown)  
 Matte Black



# PENDLETON

Movement in design, flow and overall aesthetic, the Pendleton cascades onto the scene with its stunning display of light. With a vintage nostalgia, it brings life to today's luminaires.

## FINISH OPTIONS



Brushed Nickel



Burnished Brass



Matte Black

ITEM	DESCRIPTION	FINISH	NO. OF LIGHTS	LAMP TYPE	BASE	MAX WATTS	WIDTH	HEIGHT	CERT. TYPE
60-7046	1 Lt. Pendant	Brushed Nickel	1	A19	Med.	100W	12"	14.5"	Dry
60-7047	3 Lt. Pendant	Brushed Nickel	3	B10	Cand.	60W	16"	18.38"	Dry
60-7048	6 Lt. Pendant	Brushed Nickel	6	B10	Cand.	60W	22"	24.38"	Dry
60-7056	1 Lt. Pendant	Burnished Brass	1	A19	Med.	100W	12"	14.5"	Dry
60-7057	3 Lt. Pendant	Burnished Brass	3	B10	Cand.	60W	16"	18.38"	Dry
60-7058	6 Lt. Pendant	Burnished Brass	6	B10	Cand.	60W	22"	24.38"	Dry
60-7066	1 Lt. Pendant	Matte Black	1	A19	Med.	100W	12"	14.5"	Dry
60-7067	3 Lt. Pendant	Matte Black	3	B10	Cand.	60W	16"	18.38"	Dry
60-7068	6 Lt. Pendant	Matte Black	6	B10	Cand.	60W	22"	24.38"	Dry

Additional chain: Brushed Nickel (3') 25-1069, Burnished Brass (3') 25-467, Matte Black (3') 25-475  
12' of wire and 4' of chain supplied



60-7046 - 12" W (shown)  
Brushed Nickel



60-7067 - 16" W (shown)  
Matte Black



60-7058 - 22" W (shown)  
Burnished Brass



# BREWSTER

Simplicity of form, function and style comprises the Brewster pendants, with clean lines and an understated design. Perfect for relaxed, traditional, or even modern homes; versatility at it's finest.

ITEM	DESCRIPTION	FINISH	NO. OF LIGHTS	LAMP TYPE	BASE	MAX WATTS	WIDTH	HEIGHT	CERT. TYPE
60-7696	3 Lt. Pendant	Black/ White Textile Fabric Shade / Frosted Glass Diffuser	3	A19	Med.	60W	22"	25.25"	Damp
60-7697	3 Lt. Pendant	Black / White Metal Shade	3	A19	Med.	60W	22"	25.25"	Damp

Additional Stems: (6") 25-6135, (12") 25-6136  
 (2) x 6" Stems and (2) x 12" Stems Included  
 Pendants: 12' of wire supplied



60-7696 - 22" W  
Black



60-7697 - 22" W  
Black

## FINISH OPTIONS



Black / White Metal Shade



Black / White Textile Fabric Shade / Frosted Glass Diffuser



# GEMINI

With a relaxed, contemporary design, the Gemini collection features a relaxed, contemporary style achieving form and balance. An elegant and stylish series that adds sophistication to any home.

ITEM	DESCRIPTION	FINISH	NO. OF LIGHTS	LAMP TYPE	BASE	MAX WATTS	WIDTH	HEIGHT	EXT.	CERT. TYPE
60-4754	2 Lt. Sconce	Brushed Nickel w/ Slate Gray Fabric	2	A19	Med.	60W	16"	7.25"	5.5"	Dry
60-4756	4 Lt. Pendant	Brushed Nickel w/ Slate Gray Fabric	4	A19	Med.	60W	23.5"	22.88"	•	Dry
60-4758	3 Lt. Semi-Flush	Brushed Nickel w/ Slate Gray Fabric	3	A19	Med.	60W	18.38"	12.25"	•	Dry
60-4761	2 Lt. Flush Mount	Brushed Nickel w/ Slate Gray Fabric	2	A19	Med.	60W	14.75"	7.13"	•	Damp

Additional chain: (3') 25-1069

Pendant conversion kit for semi-flush: 25-1403

Pendant: 12' of wire and 4' of chain supplied



60-4761 - 15" W



60-4758 - 19" W



60-4754 - 16" W



60-4756 - 24" W

## FINISH



Brushed Nickel w/  
Slate Gray Fabric



# FRANKIE

Versatile with a modern flair, the Frankie collection illuminates your space with warmth and texture. Inspired by mid-century design, it sets the tone for an array of luxurious happenings and a variety of decor styles. Complement the architecture of your home or work environment with this stunning collection.

ITEM	DESCRIPTION	FINISH	NO. OF LIGHTS	LAMP TYPE	BASE	MAX WATTS	WIDTH	HEIGHT	CERT TYPE
60-6543	3 Lt. Pendant	Aged Bronze Cream Fabric Shade w/ white Diffuser	3	A19	Med.	100W	15"	16"	Dry
60-6544	4 Lt. Pendant	Aged Bronze Cream Fabric Shade w/ white Diffuser	4	A19	Med.	100W	24"	24.38"	Dry
60-6545	3 Lt. Semi-Flush	Aged Bronze Cream Fabric Shade w/ white Diffuser	3	A19	Med.	100W	15"	10.63"	Dry

Additional chain: (3') 25-5004

Additional Stems: (6") 25-5011, (12") 25-5012

(2) x 6" Stems and (2) x 12" Stems Included

Pendant conversion kit for semi-flush: 25-5013

Pendants and Semi-flush: 12' of wire supplied



60-6545 - 15" W



60-6544 - 24" W (shown)

## FINISH



Aged Bronze  
Cream Fabric  
Shade w/ White  
Diffuser

# CANDICE

The Candice collection masterfully fuses the timeless elegance of traditional design with modern finishes and materials, creating lighting fixtures that are both distinctive and captivating. The result is a truly original collection, showcasing a unique blend of classic and contemporary design.



ITEM	DESCRIPTION	FINISH	NO. OF LIGHTS	LAMP TYPE	BASE	MAX WATTS	WIDTH	HEIGHT	CERT TYPE
60-4737	3 Lt. Semi-Flush	Brushed Nickel Pleated White Shades w/ Frosted diffusers	3	A19	Med.	60W	15"	12"	Dry
60-4738	1 Lt. Mini Pendant	Brushed Nickel Pleated White Shades w/ Frosted diffusers	1	A19	Med.	60W	7"	9.25"	Dry
60-4741	3 Lt. Flush Mount	Brushed Nickel Pleated White Shades w/ Frosted diffusers	3	A19	Med.	60W	15"	7.5"	Damp

6" Stems (25-2047). 12" Stems (25-2021)

(2) x 6" Stems and (2) x 12" Stems Included

Pendant conversion kit for semi-flush: 25-1403

Mini Pendant and Semi-flush: 12' of wire supplied



60-4738- 7" W

## FINISH



Brushed Nickel  
Pleated White  
Shades w/  
Frosted diffusers



60-4741- 15" W



60-4737- 15" W



# LANSING

The Lansing collection is a contemporary series with geometric details suited for today's home decor. Bring elegance and illumination to the home, impressing your guests and making a statement with Lansing.

ITEM	DESCRIPTION	FINISH	NO. OF LIGHTS	LAMP TYPE	BASE	MAX WATTS	WIDTH	HEIGHT	CERT. TYPE
60-6431	2 Lt. Sconce/Vanity	Midnight Bronze White Fabric Shade w/ Etched Opal Glass	2	B11	Cand.	60W	8"	12"	Dry
60-6432	1 Lt. Mini Pendant	Midnight Bronze White Fabric Shade w/ Etched Opal Glass	1	A19	Med.	100W	5.25"	12"	Dry
60-6434	3 Lt. Flush Mount	Midnight Bronze White Fabric Shade w/ Etched Opal Glass	3	A19	Med.	60W	16"	5.38"	Dry
60-6435	3 Lt. Pendant	Midnight Bronze White Fabric Shade w/ Etched Opal Glass	3	A19	Med.	60W	21"	18.38"	Dry
60-6436	3 Lt. Semi-Flush*	Midnight Bronze White Fabric Shade w/ Etched Opal Glass	3	A19	Med.	60W	16"	9.38"	Dry

Additional Stems: (6") 25-6416, (12") 25-6417

(2) x 6" Stems and (2) x 12" Stems Included

2 Lt. Sconce / Vanity: 3.875" Extension supplied

Pendant conversion kit for semi-flush: 25-6418

Pendants and Semi-flush: 12' of wire supplied



60-6432 - 5" W



60-6431 - 8" W  
(ADA compliant)

## FINISH



Midnight Bronze  
White Fabric  
Shade w/ Etched  
Opal Glass



60-6436 - 16" W



60-6434- 16" W



60-6435 - 21" W



# EASTON

Classic design is perfectly showcased with the Easton pendants, bringing traditional design, and refined details together beautifully. Ideal for creating a welcoming and relaxing environment, these pendants are superior lighting in a sophisticated package.

## FINISH OPTIONS



Burnished Brass  
White Linen



Polished Nickel  
White Linen

ITEM	DESCRIPTION	FINISH	NO. OF LIGHTS	LAMP TYPE	BASE	MAX WATTS	WIDTH	HEIGHT	CERT TYPE
60-7961	1 Lt. Sm. Pendant	Burnished Brass / White Linen	1	A19	Med.	100W	9.75"	19.88"	Dry
60-7962	3 Lt. Pendant	Burnished Brass / White Linen	3	A19	Med.	60W	16"	25.75"	Dry
60-7971	1 Lt. Sm. Pendant	Polished Nickel / White Linen	1	A19	Med.	100W	9.75"	19.88"	Dry
60-7972	3 Lt. Pendant	Polished Nickel / White Linen	3	A19	Med.	60W	16"	25.75"	Dry

Additional Stems: Burnished Brass (6") 25-468, (12") 25-469, Polished Nickel (6") 25-4118, (12") 25-4119

(2) x 6" Stems and (2) x 12" Stems Included

Pendants: 12' of wire supplied



60-7961 - 10" W (shown)  
Burnished Brass



60-7972- 16" W (shown)  
Polished Nickel



# ROYALE

Indulge in the glamour of the Royale Collection, where sleek Art Deco silhouettes meet modern refinement. Perfect for creating spaces with elegance and charm, it's a re imagined design that transforms any room into a statement of sophistication.

## FINISH OPTIONS



Burnished Brass /  
Ribbed Glass



Brushed Nickel /  
Ribbed Glass



60-8735 - 16" W (shown)  
Burnished Brass

ITEM	DESCRIPTION	FINISH	NO. OF LIGHTS	LAMP TYPE	BASE	MAX WATTS	WIDTH	HEIGHT	EXT	CERT TYPE
60-8721	1 Lt. Vanity	Burnished Brass / Ribbed Glass	1	A19	Med.	100W	4.5"	7"	6.25"	Damp
60-8722	2 Lt. Vanity	Burnished Brass / Ribbed Glass	2	A19	Med.	100W	14.6"	6.88"	6.25"	Damp
60-8723	3 Lt. Vanity	Burnished Brass / Ribbed Glass	3	A19	Med.	100W	24"	6.88"	6.25"	Damp
60-8724	4 Lt. Vanity	Burnished Brass / Ribbed Glass	4	A19	Med.	100W	33.5"	6.88"	6.25"	Damp
60-8725	3 Lt. Flush Mount	Brushed Nickel / Ribbed Glass	3	A19	Med.	100W	16"	5.75"	•	Damp
60-8726	6 Lt. Chandelier	Brushed Nickel / Ribbed Glass	6	A19	Med.	60W	30"	18.25"	•	Dry
60-8727	Mini Pendant	Brushed Nickel / Ribbed Glass	1	A19	Med.	100W	4.5"	5.75"	•	Dry
60-8728	Large Pendant	Brushed Nickel / Ribbed Glass	1	Globe	Med.	100W	12"	14.63"	•	Dry
60-8729	8 Lt. Chandelier	Brushed Nickel / Ribbed Glass	8	A19	Med.	60W	40"	22"	•	Dry
60-8731	1 Lt. Vanity	Brushed Nickel / Ribbed Glass	1	A19	Med.	100W	4.5"	7"	6.25"	Damp
60-8732	2 Lt. Vanity	Brushed Nickel / Ribbed Glass	2	A19	Med.	100W	14.6"	6.88"	6.25"	Damp
60-8733	3 Lt. Vanity	Brushed Nickel / Ribbed Glass	3	A19	Med.	100W	24"	6.88"	6.25"	Damp
60-8734	4 Lt. Vanity	Brushed Nickel / Ribbed Glass	4	A19	Med.	100W	33.5"	6.88"	6.25"	Damp
60-8735	3 Lt. Flush Mount	Burnished Brass / Ribbed Glass	3	A19	Med.	60W	16"	5.75"	•	Damp
60-8736	6 Lt. Chandelier	Burnished Brass / Ribbed Glass	6	A19	Med.	60W	30"	18.25"	•	Dry
60-8737	Mini Pendant	Burnished Brass / Ribbed Glass	1	A19	Med.	100W	4.5"	5.75"	•	Dry
60-8738	Large Pendant	Burnished Brass / Ribbed Glass	1	Globe	Med.	100W	12"	14.63"	•	Dry
60-8739	8 Lt. Chandelier	Burnished Brass / Ribbed Glass	8	A19	Med.	60W	40"	22"	•	Dry

Additional Stems: Burnished Brass (6") 25-492, (12") 25-493, Brushed Nickel (6") 25-2055, (12") 25-2057

(2) x 6" Stems and (2) x 12" Stems Included

Chandeliers & Pendants: 12' of wire supplied



60-8722 - 15" W (shown)  
Burnished Brass



60-8733 - 24" W (shown)  
Brushed Nickel



60-8724 - 34" W (shown)  
Burnished Brass



60-8721 - 5" W (shown)  
Burnished Brass



60-8737 - 5" W (shown)  
Brushed Nickel



60-8729 - 40" W (shown)  
Burnished Brass



60-8728 - 12" W (shown)  
Burnished Brass



# GIANNA

Step back in style and revel in the charm of retro sophistication with the Gianna Collection, a tribute to the bold aesthetics of the seventies. Effortlessly blending style with vintage allure, this collection redefines transitional design.

## FINISH OPTIONS



Brushed Nickel  
Clear Glass



Vintage Brass  
Clear Glass



60-8337 - 8" W (shown)  
Brushed Nickel



60-8348 - 12" W (shown)  
Vintage Brass

ITEM	DESCRIPTION	FINISH	NO. OF LIGHTS	LAMP TYPE	BASE	MAX WATTS	WIDTH	HEIGHT	EXT	CERT TYPE
60-8331	1 Lt. Vanity	Brushed Nickel / Clear Glass	1	A19	Med.	60W	5.5"	7.5"	7"	Damp
60-8332	2 Lt. Vanity	Brushed Nickel / Clear Glass	2	A19	Med.	60W	16"	7.5"	7"	Damp
60-8333	3 Lt. Vanity	Brushed Nickel / Clear Glass	3	A19	Med.	60W	24"	7.5"	7"	Damp
60-8334	4 Lt. Vanity	Brushed Nickel / Clear Glass	4	A19	Med.	60W	33.25"	7.5"	7"	Damp
60-8335	6 Lt. Chandelier	Brushed Nickel / Clear Glass	6	A19	Med.	60W	30"	21.75"	•	Dry
60-8336	8 Lt. Chandelier	Brushed Nickel / Clear Glass	8	A19	Med.	60W	40"	25"	•	Dry
60-8337	Mini Pendant	Brushed Nickel / Clear Glass	1	A19	Med.	60W	8"	9.5"	•	Dry
60-8338	1Lt. Med. Pendant	Brushed Nickel / Clear Glass	1	A19	Med.	60W	12"	14"	•	Dry
60-8341	1Lt. Vanity	Vintage Brass / Clear Glass	1	A19	Med.	60W	5.5"	7.5"	7"	Damp
60-8342	2 Lt. Vanity	Vintage Brass / Clear Glass	2	A19	Med.	60W	16"	7.5"	7"	Damp
60-8343	3 Lt. Vanity	Vintage Brass / Clear Glass	3	A19	Med.	60W	24"	7.5"	7"	Damp
60-8344	4 Lt. Vanity	Vintage Brass / Clear Glass	4	A19	Med.	60W	33.25"	7.5"	7"	Damp
60-8345	6 Lt. Chandelier	Vintage Brass / Clear Glass	6	A19	Med.	60W	30"	21.75"	•	Dry
60-8346	8 Lt. Chandelier	Vintage Brass / Clear Glass	8	A19	Med.	60W	40"	25"	•	Dry
60-8347	Mini Pendant	Vintage Brass / Clear Glass	1	A19	Med.	60W	8"	9.5"	•	Dry
60-8348	1Lt. Med. Pendant	Vintage Brass / Clear Glass	1	A19	Med.	60W	12"	14"	•	Dry

Additional Stems: Burnished Brass (6") 25-3086, (12") 25-3087, Brushed Nickel (6") 25-482, (12") 25-483

(2) x 6" Stems and (2) x 12" Stems Included

Chandeliers & Pendants: 12' of wire supplied



60-8331 - 6" W (shown)  
Brushed Nickel



60-8342 - 16" W (shown)  
Vintage Brass



60-8333 - 24" W (shown)  
Brushed Nickel



60-8344 - 33" W (shown)  
Vintage Brass



60-8335 - 30" W (shown)  
Brushed Nickel



60-8346 - 40" W (shown)  
Vintage Brass



# LUNE

Embrace the classic elegance of the Lune Collection, where updated Mid-Century Modern design meets today's sophisticated style. Featuring graceful lines and thoughtful details, this collection re-imagines retro aesthetics for the contemporary home.

## FINISH OPTIONS



Brushed Nickel  
Etched White Glass



Vintage Brass  
Etched White Glass



60-8220 - 16" W (shown)  
Brushed Nickel



60-8239 - 16" W (shown)  
Vintage Brass

ITEM	DESCRIPTION	FINISH	NO. OF LIGHTS	LAMP TYPE	BASE	MAX WATTS	WIDTH	HEIGHT	EXT	CERT TYPE
60-8220	3 Lt. Flush Mount	Brushed Nickel / Etched White Glass	3	A19	Med.	60W	16"	6.75"	•	Dry
60-8221	1 Lt. Vanity	Brushed Nickel / Etched White Glass	1	A19	Cand.	60W	5.25"	8.75"	7"	Damp
60-8222	2 Lt. Vanity	Brushed Nickel / Etched White Glass	2	A19	Cand.	60W	16"	8.75"	7"	Damp
60-8223	3 Lt. Vanity	Brushed Nickel / Etched White Glass	3	A19	Cand.	60W	24"	8.75"	7"	Damp
60-8224	4 Lt. Vanity	Brushed Nickel / Etched White Glass	4	A19	Cand.	60W	32"	8.75"	7"	Damp
60-8225	5 Lt. Chandelier	Brushed Nickel / Etched White Glass	5	A19	Cand.	60W	30"	10.25"	•	Dry
60-8226	6 Lt. Chandelier	Brushed Nickel / Etched White Glass	6	A19	Cand.	60W	40"	10.25"	•	Dry
60-8227	Mini Pendant	Brushed Nickel / Etched White Glass	1	A19	Med.	60W	8"	12.75"	•	Dry
60-8228	3 Lt. Pendant	Brushed Nickel / Etched White Glass	3	A19	Cand.	60W	12"	17"	•	Dry
60-8229	3 Lt. Semi Flush	Brushed Nickel / Etched White Glass	3	A19	Med.	60W	16"	10.5"	•	Dry
60-8230	3 Lt. Flush Mount	Vintage Brass / Etched White Glass	3	A19	Med.	60W	16"	6.75"	•	Dry
60-8231	1 Lt. Vanity	Vintage Brass / Etched White Glass	1	A19	Cand.	60W	5.25"	8.75"	7"	Damp
60-8232	2 Lt. Vanity	Vintage Brass / Etched White Glass	2	A19	Cand.	60W	16"	8.75"	7"	Damp
60-8233	3 Lt. Vanity	Vintage Brass / Etched White Glass	3	A19	Cand.	60W	24"	8.75"	7"	Damp
60-8234	4 Lt. Vanity	Vintage Brass / Etched White Glass	4	A19	Cand.	60W	32"	8.75"	7"	Damp
60-8235	5 Lt. Chandelier	Vintage Brass / Etched White Glass	5	A19	Cand.	60W	30"	10.25"	•	Dry
60-8236	6 Lt. Chandelier	Vintage Brass / Etched White Glass	6	A19	Cand.	60W	40"	10.25"	•	Dry
60-8237	Mini Pendant	Vintage Brass / Etched White Glass	1	A19	Med.	60W	8"	12.75"	•	Dry
60-8238	3 Lt. Pendant	Vintage Brass / Etched White Glass	3	A19	Cand.	60W	12"	17"	•	Dry
60-8239	3 Lt. Semi Flush	Vintage Brass / Etched White Glass	3	A19	Med.	60W	16"	10.5"	•	Dry

Additional Stems: Vintage Brass (6") 25-3086, (12") 25-3087, Brushed Nickel: (6") 25-482, (12") 25-483

(2) x 6" Stems and (2) x 12" Stems Included

Chandeliers & Pendants: 12' of wire supplied



60-8221 - 5" W (shown)  
Brushed Nickel



60-8222 - 16" W (shown)  
Brushed Nickel



60-8233 - 24" W (shown)  
Vintage Brass



60-8224 - 32" W (shown)  
Brushed Nickel



60-8227 - 8" W (shown)  
Brushed Nickel



60-8235 - 30" W (shown)  
Vintage Brass



60-8226 - 40" W (shown)  
Brushed Nickel



# CORDELLO

The design of the Cordello collection is traditional and elegant, with beautiful curves and crisp shades. The elongated shades add a sense of drama and are etched white, diffusing the light for a soft glow. The minimalist design is adds a timeless style suited for a variety of home decors, making Cordello an excellent choice indeed.

ITEM	DESCRIPTION	FINISH	NO. OF LIGHTS	LAMP TYPE	BASE	MAX WATTS	LENGTH	WIDTH	HEIGHT	EXT.	CERT. TYPE
60-7882	2 Lt. Sconce	Vintage Brass Etched White Opal Glass	2	B11	Cand.	60W	•	16"	14.5"	9"	Damp
60-7883	1 Lt. Sconce	Vintage Brass Etched White Opal Glass	1	B11	Cand.	60W	•	5"	14.5"	9"	Damp
60-7884	4 Lt. Chandelier	Vintage Brass Etched White Opal Glass	4	B11	Cand.	60W	18"	16"	14"	•	Dry
60-7886	6 Lt. Island Pendant	Vintage Brass Etched White Opal Glass	6	B11	Cand.	60W	38"	18"	14"	•	Dry

Additional Stems: Vintage Brass (6") 25-3086, (12") 25-3087

(2) x 6" Stems and (2) x 12" Stems Included

Sconces: CUL listed for up or down installation

Chandelier and Island Pendant: 12' of wire supplied



60-7886 - 38" L

### FINISH



Vintage Brass  
Etched White Opal Glass



60-7883 - 5" W



60-7882 - 16" W



# BROOKSIDE

If you're looking to add a touch of classic, elegant lighting to your home, the Brookside collection fits the bill. Illuminate your space beautifully and with style, choosing from a chandelier, island pendant or wall sconce, or coordinate them for a cohesive look, Brookside is fashionable lighting done right.

ITEM	DESCRIPTION	FINISH	NO. OF LIGHTS	LAMP TYPE	BASE	MAX WATTS	LENGTH	WIDTH	HEIGHT	EXT.	CERT. TYPE
60-7881	1 Lt. Sconce/Vanity	Vintage Brass Clear Glass	1	B11	Cand.	60W	•	6"	11.75"	9.5"	Damp
60-7885	4 Lt. Chandelier	Vintage Brass Clear Glass	4	B11	Cand.	60W	•	24"	11.75"	•	Dry
60-7887	6 Lt. Island Pendant	Vintage Brass Clear Glass	6	B11	Cand.	60W	42"	25"	12.25"	•	Dry

Additional Stems: Vintage Brass (6") 25-3086, (12") 25-3087

(2) x 6" Stems and (2) x 12" Stems Included

Sconce/Vanity: CUL listed for up or down installation

Chandelier and Island Pendant: 12' of wire supplied



60-7887 - 42" L



60-7885 - 24" W

## FINISH



Vintage Brass  
Clear Glass



60-7881 - 6" W



# INTERSECTION

The blend of styles (modern, industrial and chic) are incorporated beautifully into the design of the Intersection collection. A touch of nostalgia when used with filament bulbs to bring great style to your home.

ITEM	DESCRIPTION	FINISH	NO. OF LIGHTS	LAMP TYPE	BASE	MAX WATTS	WIDTH	HEIGHT	EXT.	CERT. TYPE
60-7529	1 Lt. Mini Pendant	Burnished Brass	1	T10	Med.	60W	3.5"	8.5"	•	Dry
60-7530	3 Lt. Pendant	Burnished Brass	3	T10	Med.	60W	17"	17"	•	Dry
60-7531	1 Lt. Vanity	Burnished Brass	1	T10	Med.	60W	4.5"	8.5"	5.38"	Damp
60-7532	2 Lt. Vanity	Burnished Brass	2	T10	Med.	60W	15"	8.5"	5.38"	Damp
60-7533	3 Lt. Vanity	Burnished Brass	3	T10	Med.	60W	22"	8.5"	5.38"	Damp
60-7534	4 Lt. Vanity	Burnished Brass	4	T10	Med.	60W	30.13"	8.5"	5.38"	Damp
60-7535	5 Lt. Chandelier	Burnished Brass	5	T10	Med.	60W	24"	18.88"	•	Dry
60-7536	2 Lt. Sm. Flush Mount	Burnished Brass	2	T10	Med.	60W	11"	6"	•	Damp
60-7537	2 Lt. Med. Flush Mount	Burnished Brass	2	T10	Med.	60W	14.25"	6"	•	Damp
60-7538	3 Lt. Lg. Flush Mount	Burnished Brass	3	T10	Med.	60W	17"	6"	•	Damp
60-7629	1 Lt. Mini Pendant	Polished Nickel	1	T10	Med.	60W	3.5"	8.5"	•	Dry
60-7630	3 Lt. Pendant	Polished Nickel	3	T9	Med.	60W	17"	17"	•	Dry
60-7631	1 Lt. Vanity	Polished Nickel	1	T10	Med.	60W	4.5"	8.5"	5.38"	Damp
60-7632	2 Lt. Vanity	Polished Nickel	2	T10	Med.	60W	15"	8.5"	5.38"	Damp
60-7633	3 Lt. Vanity	Polished Nickel	3	T9	Med.	60W	22"	8.5"	5.38"	Damp
60-7634	4 Lt. Vanity	Polished Nickel	4	T9	Med.	60W	30.13"	8.5"	5.38"	Damp
60-7635	5 Lt. Chandelier	Polished Nickel	5	T9	Med.	60W	24"	18.88"	•	Dry
60-7636	2 Lt. Sm. Flush Mount	Polished Nickel	2	T10	Med.	60W	11"	6"	•	Damp
60-7637	2 Lt. Med. Flush Mount	Polished Nickel	2	T10	Med.	60W	14.25"	6"	•	Damp
60-7638	3 Lt. Lg. Flush Mount	Polished Nickel	3	T10	Med.	60W	17"	6"	•	Damp

Additional chain: (3') 25-467, (3') 25-4141

Additional Stems: Brushed Brass (6") 25-468, (12") 25-469, Polished Nickel (6") 25-4118, (12") 25-4119

(2) x 6" Stems and (2) x 12" Stems Included

Vanities: CUL listed for up or down installation

Pendants and chandelier: 12' of wire and 4' of chain supplied

## FINISH OPTIONS



Burnished Brass



Polished Nickel



60-7637 - 14" (shown)  
Polished Nickel



60-7535 - 24" W (shown)  
Burnished Brass



60-7629 - 4" W (shown)  
Polished Nickel



60-7630 - 17" W (shown)  
Polished Nickel



60-7531 - 17" W (shown)  
Burnished Brass



60-7632 - 15" W (shown)  
Polished Nickel



60-7533 - 22" W (shown)  
Burnished Brass



60-7534 - 30" W (shown)  
Burnished Brass



# VALENTINE

A warm glow with modern elegance, the Valentine Collection is styled in an updated version of gas-lighting, a true past and present design for today's home lighting. With its striking combination of vintage inspiration and contemporary sophistication, this collection exudes warmth and style.

## FINISH OPTIONS



Black  
Hammered Glass



Vintage Brass  
Hammered Glass



60-8252 - 16" W (shown)  
Black



60-8263 - 24" W (shown)  
Vintage Brass



60-8251 - 6" W (shown)  
Black



60-8264 - 32" W (shown)  
Vintage Brass

ITEM	DESCRIPTION	FINISH	NO. OF LIGHTS	LAMP TYPE	BASE	MAX WATTS	WIDTH	HEIGHT	EXT	CERT TYPE
60-8251	1 Lt. Vanity	Black / Hammered Glass	1	G16.5	Cand.	60W	6"	7"	7.25"	Damp
60-8252	2 Lt. Vanity	Black / Hammered Glass	2	G16.5	Cand.	60W	16"	7"	7.25"	Damp
60-8253	3 Lt. Vanity	Black / Hammered Glass	3	G16.5	Cand.	60W	24"	7"	7.25"	Damp
60-8254	4 Lt. Vanity	Black / Hammered Glass	4	G16.5	Cand.	60W	32"	7"	7.25"	Damp
60-8255	Small Pendant	Black / Hammered Glass	1	A19	Med.	60W	8"	14.5"	•	Dry
60-8256	Med. Pendant	Black / Hammered Glass	1	A19	Med.	60W	12"	22.5"	•	Dry
60-8257	Large Pendant	Black / Hammered Glass	3	G16.5	Cand.	60W	16"	29.25"	•	Dry
60-8258	5 Lt. Chandelier	Black / Hammered Glass	5	G16.5	Cand.	60W	30"	23.5"	•	Dry
60-8259	7 Lt. Chandelier	Black / Hammered Glass	7	G16.5	Cand.	60W	40"	25.5"	•	Dry
60-8261	1 Lt. Vanity	Vintage Brass / Hammered Glass	1	G16.5	Cand.	60W	6"	7"	7.25"	Damp
60-8262	2 Lt. Vanity	Vintage Brass / Hammered Glass	2	G16.5	Cand.	60W	16"	7"	7.25"	Damp
60-8263	3 Lt. Vanity	Vintage Brass / Hammered Glass	3	G16.5	Cand.	60W	24"	7"	7.25"	Damp
60-8264	4 Lt. Vanity	Vintage Brass / Hammered Glass	4	A19	Med.	60W	32"	7"	7.25"	Damp
60-8265	Small Pendant	Vintage Brass / Hammered Glass	1	A19	Med.	60W	8"	14.5"	•	Dry
60-8266	Med. Pendant	Vintage Brass / Hammered Glass	1	A19	Med.	60W	12"	22.5"	•	Dry
60-8267	Large Pendant	Vintage Brass / Hammered Glass	3	G16.5	Cand.	60W	16"	29.25"	•	Dry
60-8268	5 Lt. Chandelier	Vintage Brass / Hammered Glass	5	G16.5	Cand.	60W	30"	23.5"	•	Dry
60-8269	7 Lt. Chandelier	Vintage Brass / Hammered Glass	7	G16.5	Cand.	60W	40"	25.5"	•	Dry

Additional Stems: Vintage Brass (6") 25-3086, (12") 25-3087, Black: (6") 25-485, (12") 25-486(2) x 6" Stems and (2) x 12" Stems Included  
Pendants: 12' of wire supplied



60-8255 - 8" W (shown)  
Black



60-8266 - 12" W (shown)  
Vintage Brass



60-8257 - 16" W (shown)  
Black



60-8269 - 40" W (shown)  
Vintage Brass



60-8258 - 30" W (shown)  
Black



# SOLARA

Introducing the Solara Collection, where timeless design takes on a fresh perspective. With graceful simplicity redefined, it's traditionally styled and features fine details, offering a harmonious balance of elegance and ease.

## FINISH OPTIONS



Matte Black  
Frosted Ribbed Glass



Natural Brass  
Frosted Ribbed Glass



60-8645 - 5" W (shown)  
Matte Black



60-8666 - 12" W (shown)  
Natural Brass

ITEM	DESCRIPTION	FINISH	NO. OF LIGHTS	LAMP TYPE	BASE	MAX WATTS	LENGTH	WIDTH	HEIGHT	EXT	CERT TYPE
60-8641	1 Lt. Vanity	Matte Black / Frosted Ribbed Glass	1	A19	Med.	100W	•	5"	13"	5.38"	Damp
60-8642	2 Lt. Vanity	Matte Black / Frosted Ribbed Glass	2	A19	Med.	100W	•	13.38"	8"	6.25"	Damp
60-8643	3 Lt. Vanity	Matte Black / Frosted Ribbed Glass	3	A19	Med.	100W	•	23"	7.25"	6.25"	Damp
60-8644	4 Lt. Vanity	Matte Black / Frosted Ribbed Glass	4	A19	Med.	100W	•	32.63"	8"	6.25"	Damp
60-8645	Mini Pendant	Matte Black / Frosted Ribbed Glass	1	A19	Med.	100W	•	5"	7.25"	•	Dry
60-8646	Pendant	Matte Black / Frosted Ribbed Glass	1	A19	Med.	100W	•	12"	20"	•	Dry
60-8647	Semi Flush	Matte Black / Frosted Ribbed Glass	3	A19	Med.	60W	•	16"	10.13"	•	Dry
60-8648	Flush Mount	Matte Black / Frosted Ribbed Glass	3	A19	Med.	60W	•	16.63"	5.63"	•	Damp
60-8649	6 Lt. Island	Matte Black / Frosted Ribbed Glass	6	A19	Med.	60W	40"	12"	7.13"	•	Dry
60-8650	5 Lt. Chandelier	Matte Black / Frosted Ribbed Glass	5	A19	Med.	60W	•	30"	11"	•	Dry
60-8651	7 Lt. Chandelier	Matte Black / Frosted Ribbed Glass	7	A19	Med.	60W	•	40"	12.88"	•	Dry
60-8661	1 Lt. Vanity	Natural Brass / Frosted Ribbed Glass	1	A19	Med.	100W	•	5"	13"	5.38"	Damp
60-8662	2 Lt. Vanity	Natural Brass / Frosted Ribbed Glass	2	A19	Med.	100W	•	13.38"	8"	6.25"	Damp
60-8663	3 Lt. Vanity	Natural Brass / Frosted Ribbed Glass	3	A19	Med.	100W	•	23"	7.75"	6.25"	Damp
60-8664	4 Lt. Vanity	Natural Brass / Frosted Ribbed Glass	4	A19	Med.	100W	•	32.63"	8"	6.25"	Damp
60-8665	Mini Pendant	Natural Brass / Frosted Ribbed Glass	1	A19	Med.	100W	•	5"	7.25"	•	Dry
60-8666	Pendant	Natural Brass / Frosted Ribbed Glass	1	A19	Med.	100W	•	12"	20"	•	Dry
60-8667	Semi Flush	Natural Brass / Frosted Ribbed Glass	3	A19	Med.	60W	•	16"	10.13"	•	Dry
60-8668	Flush Mount	Natural Brass / Frosted Ribbed Glass	3	A19	Med.	60W	•	16.63"	5.63"	•	Damp
60-8669	6 Lt. Island	Natural Brass / Frosted Ribbed Glass	6	A19	Med.	60W	40"	12"	7.13"	•	Dry
60-8670	5 Lt. Chandelier	Natural Brass / Frosted Ribbed Glass	5	A19	Med.	60W	•	30"	11"	•	Dry
60-8671	7 Lt. Chandelier	Natural Brass / Frosted Ribbed Glass	7	A19	Med.	60W	•	40"	12.88"	•	Dry

Additional Stems: Vintage Brass (6") 25-6841, (12") 25-6842, Black: (6") 25-6135, (12") 25-6136

(2) x 6" Stems and (2) x 12" Stems Included

Pendants: 12' of wire supplied



60-8668 - 17" W (shown)  
Natural Brass



60-8641 - 5" W (shown)  
Matte Black  
(shown with optional stem)



60-8649 - 40" L (shown)  
Matte Black



62-8642 - 13" W (shown)  
Matte Black



60-8651 - 40" W (shown)  
Matte Black



60-8663 - 23" W (shown)  
Natural Brass



# LIAM

With its broad appeal and versatile charm, the Liam Collection elevates any room into a haven of style and comfort. Illuminate your world with design that speaks to both tradition and modernity crafted with beauty in every detail.



## FINISH OPTIONS



Burnished Brass  
White Opal Glass



Matte Black  
White Opal Glass



60-8201 - 5" W (shown)  
Burnished Brass



60-8213 - 22" W (shown)  
Matte Black

ITEM	DESCRIPTION	FINISH	NO. OF LIGHTS	LAMP TYPE	BASE	MAX WATTS	LENGTH	WIDTH	HEIGHT	EXT	CERT TYPE
60-8201	1 Lt. Vanity	Burnished Brass White Opal Glass	1	A19	Med.	100W	•	4.75"	11.38"	6.5"	Damp
60-8202	2 Lt. Vanity	Burnished Brass White Opal Glass	2	A19	Med.	100W	•	16"	9.63"	6.5"	Damp
60-8203	3 Lt. Vanity	Burnished Brass White Opal Glass	3	A19	Med.	100W	•	22"	12.38"	7"	Damp
60-8204	Pendant	Burnished Brass White Opal Glass	3	A19	Med.	60W	•	15.88"	17.13"	•	Dry
60-8205	Mini Pendant	Burnished Brass White Opal Glass	1	A19	Med.	60W	•	4.13"	21.38"	•	Dry
60-8206	6 Lt. Chandelier	Burnished Brass White Opal Glass	6	A19	Med.	60W	•	25"	16.38"	•	Dry
60-8207	Flush Mount	Burnished Brass White Opal Glass	3	A19	Med.	60W	•	16.63"	6.38"	•	Damp
60-8208	Island Pendant	Burnished Brass White Opal Glass	3	A19	Med.	60W	36"	4.13"	25.13"	•	Dry
60-8209	9 Lt. Chandelier	Burnished Brass White Opal Glass	9	A19	Med.	60W	•	30"	20.88"	•	Dry
60-8211	1 Lt. Vanity	Matte Black White Opal Glass	1	A19	Med.	100W	•	4.75"	11.38"	6.5"	Damp
60-8212	2 Lt. Vanity	Matte Black White Opal Glass	2	A19	Med.	100W	•	16"	9.63"	6.5"	Damp
60-8213	3 Lt. Vanity	Matte Black White Opal Glass	3	A19	Med.	100W	•	22"	12.38"	7"	Damp
60-8214	Pendant	Matte Black White Opal Glass	3	A19	Med.	60W	•	15.88"	17.13"	•	Dry
60-8215	Mini Pendant	Matte Black White Opal Glass	1	A19	Med.	60W	•	4.13"	21.38"	•	Dry
60-8216	6 Lt. Chandelier	Matte Black White Opal Glass	6	A19	Med.	60W	•	25"	16.38"	•	Dry
60-8217	Flush Mount	Matte Black White Opal Glass	3	A19	Med.	60W	•	16.63"	6.38"	•	Damp
60-8218	Island Pendant	Matte Black White Opal Glass	3	A19	Med.	60W	36"	4.13"	25.13"	•	Dry
60-8219	9 Lt. Chandelier	Matte Black White Opal Glass	9	A19	Med.	60W	•	30"	20.88"	•	Dry

Additional chain: Brushed Nickel (3') 25-1069, Burnished Brass (3') 25-467, Matte Black (3') 25-475

Pendants: 12' of wire and 4' of chain supplied



60-8209 - 30" W (shown)  
Burnished Brass



60-8208 - 36" L (shown)  
Burnished Brass

60-8205 - 4" W (shown)  
Burnished Brass



60-8216 - 25" W (shown)  
Matte Black



60-8214 - 16" W (shown)  
Matte Black



60-8217 - 17" W (shown)  
Matte Black



# GRAYSON

Rustic charm meets contemporary style in the Grayson Collection, designed to bring industrial farmhouse elegance to today's interiors. Ideal for creating inviting spaces with character, the clean lines and textured details capture the essence of enduring design.



## FINISH



Matte Black  
Clear Ribbed Glass



60-8608 - 14" W (shown)

ITEM	DESCRIPTION	FINISH	NO. OF LIGHTS	LAMP TYPE	BASE	MAX WATTS	LENGTH	WIDTH	HEIGHT	EXT	CERT TYPE
60-8601	1 Lt. Vanity	Matte Black / Clear Ribbed Glass	1	A19	Med.	100W	•	5"	7.38"	6"	Damp
60-8602	2 Lt. Vanity	Matte Black / Clear Ribbed Glass	2	A19	Med.	100W	•	14.5"	7.5"	6"	Damp
60-8603	3 Lt. Vanity	Matte Black / Clear Ribbed Glass	3	A19	Med.	100W	•	24"	7.5"	6"	Damp
60-8604	4 Lt. Vanity	Matte Black / Clear Ribbed Glass	4	A19	Med.	100W	•	33.5"	7.5"	6"	Damp
60-8605	Mini Pendant	Matte Black / Clear Ribbed Glass	1	A19	Med.	100W	•	5"	7"	•	Dry
60-8606	Small Pendant	Matte Black / Clear Ribbed Glass	1	A19	Med.	100W	•	8"	11"	•	Dry
60-8607	Large Pendant	Matte Black / Clear Ribbed Glass	1	A19	Med.	100W	•	12"	17.13"	•	Dry
60-8608	Small Flush Mount	Matte Black / Clear Ribbed Glass	2	A19	Med.	60W	•	13.5"	5.75"	•	Damp
60-8609	Large Flush Mount	Matte Black / Clear Ribbed Glass	3	A19	Med.	60W	•	17.25"	7"	•	Damp
60-8610	Island Pendant	Matte Black / Clear Ribbed Glass	6	A19	Med.	60W	34"	14.5"	9.38"	•	Dry
60-8611	5 Lt. Chandelier	Matte Black / Clear Ribbed Glass	5	A19	Med.	60W	•	30"	9.13"	•	Dry

Additional Stems: (6") 25-6135, (12") 25-6136

(2) x 6" Stems and (2) x 12" Stems Included

Pendants: 12' of wire supplied



60-8601 - 5" W



60-8602 - 15" W



60-8603 - 24" W



60-8604 - 34" W



60-8606 - 8" W (shown)



60-8605 - 5" W



60-8610 - 34" L



60-8611 - 30" W



# CLARKSVILLE



Simplicity takes center stage as the Clarksville Collection celebrates the beauty found in uncomplicated design. Modernity is seamlessly woven into each fixture, offering clean lines and a slim silhouette that harmonizes with any setting, enduring beauty found in simplicity and classic charm.

## FINISH



Matte Black  
Clear Glass



60-8065 - 15" W

ITEM	DESCRIPTION	FINISH	NO. OF LIGHTS	LAMP TYPE	BASE	MAX WATTS	WIDTH	HEIGHT	EXT	CERT TYPE
60-8061	1 Lt. Vanity	Matte Black Clear Glass	1	A19	Med.	60W	4.5"	7.25"	6.5"	Damp
60-8062	2 Lt. Vanity	Matte Black Clear Glass	2	A19	Med.	60W	14"	7.25"	5.88"	Damp
60-8063	3 Lt. Vanity	Matte Black Clear Glass	3	A19	Med.	60W	24"	7.25"	5.88"	Damp
60-8064	5" Mini Pendant	Matte Black Clear Glass	1	A19	Med.	60W	4"	7.25"	•	Dry
60-8065	15" Flush Mount	Matte Black Clear Glass	3	A19	Med.	60W	15"	6.13"	•	Damp
60-8066	5 Lt. Chandelier	Matte Black Clear Glass	5	A19	Med.	60W	28"	9"	•	Dry

Additional Stems: (6") 25-3041, (12") 25-3042

(2) x 6" Stems and (2) x 12" Stems Included

Vanities: CUL listed for up or down installation

Chandelier & Mini Pendant: 12' of Wire Supplied



60-8061 - 5" W



60-8062 - 14" W



60-8063 - 24" W



60-8064 - 5" W



60-8066 - 28" W



# RUSSEL

Introducing the Russel Lighting Collection, a lighting ensemble designed to infuse your space with luminosity and modern elegance. These beautiful fixtures for your bathroom, bedroom, dining room, entry way, and kitchen, a full suite of pieces that transcend trends, with style that will stand the test of time

ITEM	DESCRIPTION	FINISH	NO. OF LIGHTS	LAMP TYPE	BASE	MAX WATTS	WIDTH	HEIGHT	EXT.	CERT TYPE
60-8021	1 Lt. Vanity	Matte Black Satin White Glass	1	A19	Med.	60W	5.38"	8.13"	6.88"	Damp
60-8022	2 Lt. Vanity	Matte Black Satin White Glass	2	A19	Med.	60W	14.75"	7.25"	6.88"	Damp
60-8023	3 Lt. Vanity	Matte Black Satin White Glass	3	A19	Med.	60W	24"	7.25"	6.88"	Damp
60-8024	10" Mini Pendant	Matte Black Satin White Glass	1	A19	Med.	60W	10"	9.125"	•	Dry
60-8025	10" Semi Flush	Matte Black Satin White Glass	1	A19	Med.	60W	10"	10.25"	•	Dry
60-8026	14" Pendant	Matte Black Satin White Glass	1	A19	Med.	60W	14"	10.38"	•	Dry
60-8027	6 Lt. Chandelier	Matte Black Satin White Glass	6	A19	Med.	60W	28"	7"	•	Dry

Additional Stems: (6") 25-3041, (12") 25-3042  
 (2) x 6" Stems and (2) x 12" Stems Included  
 Vanities: CUL listed for up or down installation  
 Chandelier & Pendant: 12' of Wire Supplied



60-8025 - 10" W



60-8024 - 10" W



60-8026 - 14" W

## FINISH



Matte Black Satin White Glass



60-8021 - 5" W



60-8022 - 15" W



60-8023 - 24" W



60-8027 - 28" W



# SKYBRIDGE

Unique glass and fixture details rise to new heights with the Skybridge series. With a broad appeal for many home decors with its versatile finish and clear glass. A showcase in design with a bold stance, it soars in both style and substance.

## FINISH OPTIONS



Matte Black  
Clear Glass



Brushed Nickel  
Clear Glass



60-7113 - 23" W (shown)  
Brushed Nickel

ITEM	DESCRIPTION	FINISH	NO. OF LIGHTS	LAMP TYPE	BASE	MAX WATTS	LENGTH	WIDTH	HEIGHT	EXT.	CERT. TYPE
60-7101	1 Lt. Vanity/Sconce	Matte Black Clear Glass	1	A19	Med.	60W	•	5"	8.38"	6.75"	Damp
60-7102	2 Lt. Vanity	Matte Black Clear Glass	2	A19	Med.	60W	•	14.13"	8.63"	6.75"	Damp
60-7103	3 Lt. Vanity	Matte Black Clear Glass	3	A19	Med.	60W	•	23.25"	8.63"	6.75"	Damp
60-7104	5 Lt. Island Pendant	Matte Black Clear Glass	5	A19	Med.	60W	42"	5"	9"	•	Dry
60-7105	5 Lt. Chandelier	Matte Black Clear Glass	5	A19	Med.	60W	•	27"	15"	•	Dry
60-7106	1 Lt. Mini Pendant	Matte Black Clear Glass	1	A19	Med.	60W	•	5"	8"	•	Dry
60-7111	1 Lt. Vanity/Sconce	Brushed Nickel Clear Glass	1	A19	Med.	60W	•	5"	8.38"	6.75"	Damp
60-7112	2 Lt. Vanity	Brushed Nickel Clear Glass	2	A19	Med.	60W	•	14.13"	8.63"	6.75"	Damp
60-7113	3 Lt. Vanity	Brushed Nickel Clear Glass	3	A19	Med.	60W	•	23.25"	8.63"	6.75"	Damp
60-7114	5 Lt. Island Pendant	Brushed Nickel Clear Glass	5	A19	Med.	60W	42"	5"	9"	•	Dry
60-7115	5 Lt. Chandelier	Brushed Nickel Clear Glass	5	A19	Med.	60W	•	27"	15"	•	Dry
60-7116	1 Lt. Mini Pendant	Brushed Nickel Clear Glass	1	A19	Med.	60W	•	5"	8"	•	Dry

Additional Stems: Black (6") 25-3041, (12") 25-3042, Brushed Nickel (6") 25-2057, (12") 25-2055

(2) x 6" Stems and (2) x 12" Stems Included

Pendants and chandeliers: 12' of wire supplied



60-7105 - 27" W (shown)  
Matte Black



60-7104 - L" W (shown)  
Matte Black



60-7106 - 5" W (shown)  
Matte Black

# SHERWOOD

Sherwood light fixtures are a sophisticated lighting solution for inside the home. Illuminate living rooms dining rooms hallways, and foyers, with these iron black fixtures featuring brushed nickel accents. Contemporary and elegant, the Sherwood collection adds style to any home decor.

ITEM	DESCRIPTION	FINISH	NO. OF LIGHTS	LAMP TYPE	BASE	MAX WATTS	LENGTH	WIDTH	HEIGHT	EXT.	CERT. TYPE
60-6121	1Lt. Sconce/Vanity	Iron Black Br. Nickel Accents w/ Clear Glass	1	T9*	Med.	40W	•	5.5"	11.63"	5.88"	Damp
60-6122	2 Lt. Vanity	Iron Black Br. Nickel Accents w/ Clear Glass	2	T9*	Med.	60W	•	16"	10.38"	5.88"	Damp
60-6123	3 Lt. Vanity	Iron Black Br. Nickel Accents w/ Clear Glass	3	T9*	Med.	60W	•	24"	10.38"	8.63"	Damp
60-6124	6 Lt. Island Pendant	Iron Black Br. Nickel Accents w/ Clear Glass	6	T9*	Med.	60W	38"	14"	24"	•	Dry
60-6125	4 Lt. Pendant	Iron Black Br. Nickel Accents w/ Frosted Glass	4	A19	Med.	60W	•	25.88"	27.13"	•	Dry
60-6126	2 Lt. Flush Mount	Iron Black Br. Nickel Accents w/ Frosted Glass	2	A19	Med.	60W	•	14.75"	6.63"	•	Damp
60-6127	4 Lt. Open Cage Foyer	Iron Black Br. Nickel Accents w/ Clear Glass	4	T9*	Med.	60W	•	17"	35.5"	•	Dry
60-6128	8 Lt. Chandelier	Iron Black Br. Nickel Accents w/ Clear Glass	8	T9*	Med.	60W	25"	25"	33.38"	•	Dry
60-6129	4 Lt. Vanity	Iron Black Br. Nickel Accents w/ Clear Glass	4	T9*	Med.	60W	•	32"	10.38"	8.63"	Damp

Additional chain: (3') 25-6125

Chandeliers and pendants: 12' of wire and 4' of chain supplied



60-6121 - 6" W  
Iron Black w/ Clear Glass



60-6129 - 32" W (shown)  
Iron Black w/ Clear Glass



60-6126 - 15" W  
Iron Black w/ Frosted Glass

## FINISH OPTIONS



Iron Black Brushed Nickel Accents w/ Clear Glass



Iron Black Brushed Nickel Accents w/ Frosted Glass



\*T9 Vintage lamps included

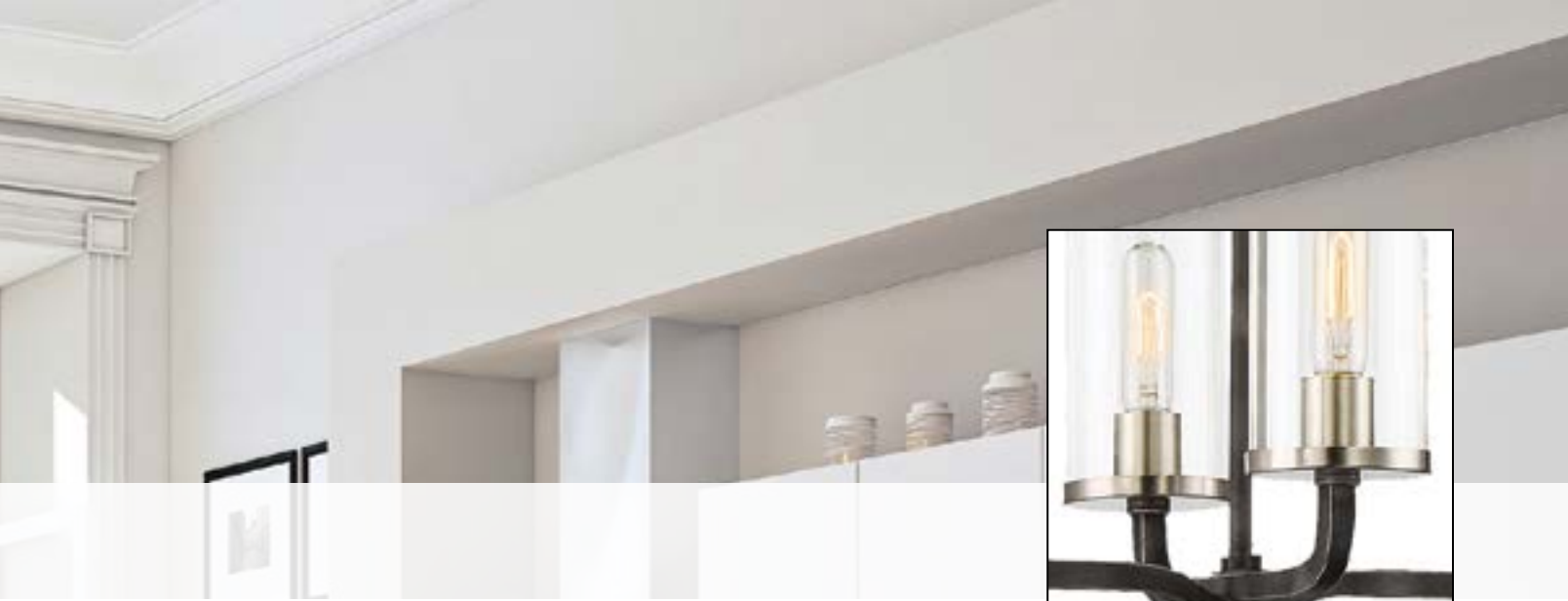

60-6128 - 25" L  
Iron Black w/ Clear Glass



60-6124 - 38" L  
Iron Black w/ Clear Glass



60-6127 - 17" W  
Iron Black w/ Clear Glass



60-6125 - 26" W  
Iron Black w/ Frosted Glass



# WARREN

Illuminate your world with the Warren Series and discover the art of transitional design, where classic meets modern in perfect harmony. A fine balance of dark and light, to illuminate your world with it's chic design.

ITEM	DESCRIPTION	FINISH	NO. OF LIGHTS	LAMP TYPE	BASE	MAX WATTS	WIDTH	HEIGHT	EXT.	CERT TYPE
60-8031	1 Lt. Vanity	Gunmetal Satin White Glass	1	A19	Med.	60W	5"	9.38"	7.38"	Damp
60-8032	2 Lt. Vanity	Gunmetal Satin White Glass	2	A19	Med.	60W	14.5"	9.38"	7.38"	Damp
60-8033	3 Lt. Vanity	Gunmetal Satin White Glass	3	A19	Med.	60W	24"	9.38"	7.38"	Damp
60-8034	15" Flush Mount	Gunmetal Satin White Glass	2	A19	Med.	60W	15"	5.75"	•	Damp
60-8035	13" Semi Flush	Gunmetal Satin White Glass	1	A19	Med.	60W	13.13"	6.5"	•	Dry
60-8036	8" Mini Pendant	Gunmetal Satin White Glass	1	A19	Med.	60W	8"	10"	•	Dry
60-8037	17" Pendant	Gunmetal Satin White Glass	3	A19	Med.	60W	17"	15"	•	Dry
60-8038	5 Lt. Chandelier	Gunmetal Satin White Glass	5	A19	Med.	60W	28"	13.63"	•	Dry

Additional Stems: (6") 25-340, (12") 25-341

(2) x 6" Stems and (2) x 12" Stems Included

Vanities: CUL listed for up or down installation

Chandelier, Pendant & Mini Pendant: 12' of Wire Supplied



60-8031 - 5" W



60-8033 - 24" W (shown)



60-8034 - 15" W



60-8035 - 13" W

## FINISH



Gun Metal  
Satin White Glass



60-8036 - 8" W



60-8037 - 17" W



60-8038 - 28" W



# CALETA

The Caleta five-light chandelier is an elegant lighting solution with clean lines and a modern style for any space. A balanced and simple design that is appealing and understated, completes the overall aesthetic of this chic collection.

## FINISH



Black  
White Frosted Glass



60-7313 - 24" W (shown)

ITEM	DESCRIPTION	FINISH	NO. OF LIGHTS	LAMP TYPE	BASE	MAX WATTS	WIDTH	HEIGHT	EXT.	CERT. TYPE
60-7311	1 Lt. Sconce/Vanity	Black White Frosted Glass	1	A19	Med.	60W	4.75"	7.13"	5.75"	Damp
60-7312	2 Lt. Vanity	Black White Frosted Glass	2	A19	Med.	60W	15"	7.13"	6.5"	Damp
60-7313	3 Lt. Vanity	Black White Frosted Glass	3	A19	Med.	60W	24"	7.13"	6.5"	Damp
60-7314	1 Lt. Mini Pendant	Black White Frosted Glass	1	A19	Med.	60W	4.25"	7.13"	•	Dry
60-7315	5 Lt. Chandelier	Black White Frosted Glass	5	A19	Med.	60W	27.38"	27.13"	•	Dry

Additional Stems: (6") 25-479, (12") 25-480

(2) x 6" Stems and (2) x 12" Stems Included

Sconce/Vanity: CUL listed for up or down installation

Chandelier and pendant: 12' of wire supplied



60-7311 - 5" W



60-7314 - 4" W



60-7315 - 27" W



# INTENTION

The Intention collection is an eye-catching that is contemporary yet industrial. The two-tone finishes and G25 bulb round out the design. A stylish and functional series with a bold look for any room in the home.

## FINISH



Warm Brass with  
Black Finish



60-6971 - 5" W

ITEM	DESCRIPTION	FINISH	NO. OF LIGHTS	LAMP TYPE	BASE	MAX WATTS	LENGTH	WIDTH	HEIGHT	EXT.	CERT. TYPE
60-6971	1 Lt. Sconce/Vanity	Warm Brass w/ Black	1	G25	Med.	60W	•	4.5"	6.5"	5.25"	Damp
60-6972	2 Lt. Vanity	Warm Brass w/ Black	2	G25	Med.	60W	•	12.25"	5.5"	5.75"	Damp
60-6973	3 Lt. Vanity	Warm Brass w/ Black	3	G25	Med.	60W	•	17"	5.5"	7"	Damp
60-6974	4 Lt. Vanity	Warm Brass w/ Black	4	G25	Med.	60W	•	21.75"	5.5"	7"	Damp
60-6975	1 Lt. Mini Pendant	Warm Brass w/ Black	1	G25	Med.	60W	•	2.75"	5.5"	•	Dry
60-6976	6 Lt. Chandelier	Warm Brass w/ Black	6	G25	Med.	60W	23.5"	23.5"	6"	•	Dry
60-6977	6 Lt. Island Pendant	Warm Brass w/ Black	6	G25	Med.	60W	32.5"	11.5"	5.5"	•	Dry

Additional Stems: (6") 25-485, (12") 25-486  
 (2) x 6" Stems and (2) x 12" Stems Included  
 Sconce/Vanity: CUL listed for up or down installation  
 Chandelier and Pendants: 12' of wire supplied



60-6974 - 22" W (shown)



60-6975 - 3" W



60-6976 - 24" W



60-6977 - 33" L



# CHASSIS

The Chassis collection beautifully showcases design of color, form and function. Creating an understated yet classy aesthetic, this elegant, eye-catching series, is perfect for today's home lighting.

ITEM	DESCRIPTION	FINISH	NO. OF LIGHTS	LAMP TYPE	BASE	MAX WATTS	LENGTH	WIDTH	HEIGHT	EXT.	CERT. TYPE
60-6641	1 Lt. Mini Pendant	Matte Black w/ Copper Brushed Brass	1	G25	Med.	60W	•	10"	8.13"	•	Dry
60-6642	3 Lt. Pendant	Matte Black w/ Copper Brushed Brass	3	A19	Med.	60W	•	20"	19"	•	Dry
60-6643	3 Lt. Semi-Flush†	Matte Black w/ Copper Brushed Brass	3	A19	Med.	60W	•	14"	12"	•	Dry
60-6644	4 Lt. Island Pendant	Matte Black w/ Copper Brushed Brass	4	A19	Med.	60W	40"	12"	10.38"	•	Dry
60-6651	1 Lt. Sconce	Matte Black w/ Copper Brushed Brass	1	G25	Med.	60W	•	7.5"	5"	4.63"	Damp
60-6652	2 Lt. Vanity	Matte Black w/ Copper Brushed Brass	2	G25	Med.	60W	•	15.75"	4.75"	4.63"	Damp
60-6653	3 Lt. Vanity	Matte Black w/ Copper Brushed Brass	3	G25	Med.	60W	•	24"	4.75"	4.63"	Damp
60-6654	4 Lt. Vanity	Matte Black w/ Copper Brushed Brass	4	G25	Med.	60W	•	32.25"	4.75"	4.63"	Damp

Additional Stems: (6") 25-492, (12") 25-493  
 (2) x 6" Stems and (2) x 12" Stems Included  
 Pendant conversion kit for semi flush: 25-461  
 Semi Flush and pendants: 12' of wire supplied

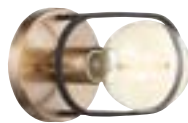

60-6651 - 8" W  
 (vertical or horizontal mount optional)



60-6652 - 16" W  
 (Vertical or horizontal mount optional)

## FINISH



Matte Black w/  
 Copper Brushed  
 Brass



60-6653 - 24" W  
 (vertical or horizontal mount optional)



60-6654 - 32" W  
 (vertical or horizontal mount optional)



60-6641 - 10" W



60-6643 - 14" W



60-6642 - 20" W



60-6644- 40" L



# PAYNE

The Payne collection offers an elegant lighting solution with a refined, understated design, perfect for your home. With its chic, traditional aesthetic, enhance your space with sophistication and grace, seamlessly blending into any décor.

ITEM	DESCRIPTION	FINISH	NO. OF LIGHTS	LAMP TYPE	BASE	MAX WATTS	LENGTH	WIDTH	HEIGHT	EXT.	CERT TYPE
60-6411	1 Lt. Sconce/Vanity	Midnight Bronze Clear Beveled Glass	1	G25	Med.	60W	•	8"	8"	5.5"	Dry
60-6412	1 Lt. Mini Pendant	Midnight Bronze Clear Beveled Glass	1	G25	Med.	60W	•	6.5"	8.5"	•	Dry
60-6413	4 Lt. Semi-Flush*	Midnight Bronze Clear Beveled Glass	4	G25	Med.	60W	•	17.13"	11.63"	•	Dry
60-6414	4 Lt. Pendant	Midnight Bronze Clear Beveled Glass	4	G25	Med.	60W	•	22"	8"	•	Dry
* 60-6415	4 Lt. Foyer	Midnight Bronze Clear Beveled Glass	4	T9*	Med.	60W	•	14"	20.75"	•	Dry
60-6416	5 Lt. Pendant	Midnight Bronze Clear Beveled Glass	5	G25	Med.	60W	•	26"	12.5"	•	Dry
60-6417	4 Lt. Island Pendant	Midnight Bronze Clear Beveled Glass	4	G25	Med.	60W	42"	10"	9"	•	Dry

Additional Stems: (6") 25-6416, (12") 25-6417  
 (2) x 6" Stems and (2) x 12" Stems Included  
 Pendant conversion kit for semi-flush: 25-6418  
 Sconce/Vanity: CUL listed for up or down installation  
 Semi-flush and Pendants: 12' of wire supplied



60-6411 - 8" W



60-6413 - 17" W



60-6412 - 7" W

## FINISH



Midnight Bronze  
 Clear Beveled  
 Glass



60-6414 - 22" W



60-6416 - 26" W



60-6417 - 42" L



60-6415 - 14" W



\*T9 Vintage lamps included

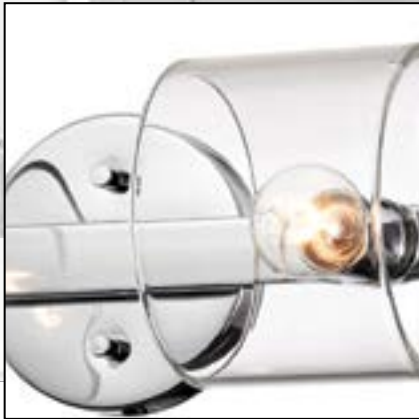

# MARLOWE

Perfectly balanced in form, design, and function, the Marlowe Series captivates with its contemporary style. A haven of style and crafted with precision, the refined simplicity makes it a versatile choice for a variety of settings, from chic urban lofts to sophisticated suburbia.

## FINISH



Polished Nickel  
Clear Glass



60-8074 - 15" W

ITEM	DESCRIPTION	FINISH	NO. OF LIGHTS	LAMP TYPE	BASE	MAX WATTS	WIDTH	HEIGHT	EXT.	CERT TYPE
60-8071	1 Light Vanity	Polished Nickel Clear Glass	1	G16.5	Cand.	60W	4.88"	5.13"	6.5"	Damp
60-8072	2 Light Vanity	Polished Nickel Clear Glass	2	G16.5	Cand.	60W	15.5"	5.13"	7.25"	Damp
60-8073	3 Light Vanity	Polished Nickel Clear Glass	3	G16.5	Cand.	60W	24"	5.13"	7.25"	Damp
60-8074	15" Flush Mount	Polished Nickel Clear Glass	3	G16.5	Cand.	60W	15"	5.75"	•	Damp
60-8075	5 Light Chandelier	Polished Nickel Clear Glass	5	G16.5	Cand.	60W	28"	10"	•	Dry

Additional Stems: (6") 25-301, (12") 25-302

(2) x 6" Stems and (2) x 12" Stems Included

Vanities (60-8072), (60-8073): CUL listed for horizontal or vertical installation

Chandelier: 12' of Wire Supplied



60-8075 - 28" W



60-8071 - 5" W



60-8072 - 15" W



60-8073 - 24" W



# BENTO

The Contemporary elegance of the Bento is expressed by the simplistic lines of the Bento collection. Illuminate living rooms, hallways, and dining rooms with this stylish single light vanity fixture. Understated, yet boldly visible, Bento's highly Polished Chrome frame and square Satin White glass shades add an illuminating presence to any room.

## FINISH



Polished Nickel w/  
Satin White Glass



60-4084 - 30" W (shown)



60-4081 - 5" W

ITEM	DESCRIPTION	FINISH	NO. OF LIGHTS	LAMP TYPE	BASE	MAX WATTS	LENGTH	WIDTH	HEIGHT	EXT.	CERT. TYPE
60-4081	1 Lt. Vanity	Polished Chrome w/ Satin White Glass	1	A19	Med.	100W	•	5.25"	8.5"	7"	Damp
60-4082	2 Lt. Vanity	Polished Chrome w/ Satin White Glass	2	A19	Med.	100W	•	14.25"	9.25"	7"	Damp
60-4083	3 Lt. Vanity	Polished Chrome w/ Satin White Glass	3	A19	Med.	100W	•	22"	9.25"	7"	Damp
60-4084	4 Lt. Vanity	Polished Chrome w/ Satin White Glass	4	A19	Med.	100W	•	30"	9.25"	7"	Damp
60-4085	3 Lt. Chandelier	Polished Chrome w/ Satin White Glass	3	A19	Med.	60W	•	20.25"	21"	•	Dry
60-4086	5 Lt. Chandelier	Polished Chrome w/ Satin White Glass	5	A19	Med.	60W	•	25.75"	24.75"	•	Dry
60-4087	3 Lt. Semi-Flush	Polished Chrome w/ Satin White Glass	3	A19	Med.	60W	•	13"	8.88"	•	Dry
60-4088	3 Lt. Flush Mount	Polished Chrome w/ Satin White Glass	3	A19	Med.	60W	•	13"	6.25"	•	Damp
60-4091	5 Lt. Island Pendant	Polished Chrome w/ Satin White Glass	5	A19	Med.	60W	37.5"	5.38"	7.75"	•	Dry

Additional chain: (3') 25-2077,

Additional Stems: (6") 25-2062, (12") 25-2061,

\*Pendant conversion kit for semi-flush: 25-4143

Chandeliers and pendants: 12' of wire and 4' of chain supplied



60-4085 - 20" W



60-4086 - 26" W



60-4087 - 13" W



60-4091 - 38" L



60-4088 - 13" W



# ODEON

The Odeon Collection embodies a classically modern charm, artfully blending the bold elegance of Art Deco with sleek, contemporary aesthetics. Inspired by the geometric precision of the early 20th century, each piece in the collection radiates sophistication, transforming any space with its refined architectural beauty.

## FINISH



Brushed Nickel  
White Glass



60-2864 - 17" W (shown)



60-2868 - 6" W

ITEM	DESCRIPTION	FINISH	NO. OF LIGHTS	LAMP TYPE	BASE	MAX WATTS	WIDTH	HEIGHT	EXT.	CERT. TYPE
60-2851	3 Lt. Chandelier	Brushed Nickel White Glass	3	A19	Med.	60W	17.75"	18.5"	•	Dry
60-2853	6 Lt. Chandelier	Brushed Nickel White Glass	6	A19	Med.	60W	28"	19.88"	•	Dry
60-2857	4 Lt. Pendant	Brushed Nickel White Glass	4	A19	Med.	60W	17"	17"	•	Dry
60-2859	2 Lt. Flush Mount	Brushed Nickel White Glass	2	A19	Med.	60W	13.13"	4.88"	•	Damp
60-2862	3 Lt. Med. Flush Mount	Brushed Nickel White Glass	3	A19	Med.	60W	15"	5.63"	•	Damp
60-2864	3 Lt. Flush Mount	Brushed Nickel White Glass	3	A19	Med.	60W	17"	5.63"	•	Damp
60-2866	1 Lt. Mini Pendant	Brushed Nickel White Glass	1	A19	Med.	60W	5.13"	8.5"	•	Dry
60-2868	1 Lt. Sconce	Brushed Nickel White Glass	1	A19	Med.	100W	6"	8"	4.25"	Damp
60-2871	2 Lt. Sconce	Brushed Nickel White Glass	2	A19	Med.	100W	15.5"	5"	4.25"	Damp
60-2873	3 Lt. Sconce	Brushed Nickel White Glass	3	A19	Med.	100W	23.88"	5"	4.25"	Damp
60-2875	4 Lt. Sconce	Brushed Nickel White Glass	4	A19	Med.	100W	32"	5"	4.25"	Damp

Additional chain: (3') 25-1069

Additional Stems: (6") 25-2047, (12") 25-2021

(2) x 6" Stems and (2) x 12" Stems Included

Chandeliers are convertible for arm up or down use

Chandeliers and pendants: 12' of wire and 4' of chain supplied



60-2851 - 18" W (shown)



60-2857 - 17" W



60-2866 - 5" W



60-2875 - 32" W (shown)

# SOMMERSET

The Somerset Collection shows off its refined style effortlessly to complement both modern and transitional aesthetics, while also fitting beautifully into a coastal setting. The perfect romantic illumination, Somerset casts a soft, flattering glow that enhances the charm of any room.

ITEM	DESCRIPTION	FINISH	NO. OF LIGHTS	LAMP TYPE	BASE	MAX WATTS	LENGTH	WIDTH	HEIGHT	EXT.	CERT. TYPE
60-7168	2 Lt. Flush Mount	Brushed Nickel Clear Glass	2	A19	Med.	60W	•	12.88"	5.63"	•	Damp
60-7169	3 Lt. Flush Mount	Brushed Nickel Clear Glass	3	A19	Med.	60W	•	15"	5.63"	•	Damp
60-7170	1 Lt. Mini Pendant	Brushed Nickel Clear Glass	1	A19	Med.	60W	•	4.75"	8.25"	•	Dry
60-7171	1 Lt. Vanity	Brushed Nickel Clear Glass	1	A19	Med.	60W	•	4.63"	10.75"	5.75"	Damp
60-7172	2 Lt. Vanity	Brushed Nickel Clear Glass	2	A19	Med.	60W	•	15"	10.75"	5.75"	Damp
60-7173	3 Lt. Vanity	Brushed Nickel Clear Glass	3	A19	Med.	60W	•	21"	10.75"	5.75"	Damp
60-7174	4 Lt. Vanity	Brushed Nickel Clear Glass	4	A19	Med.	60W	•	29.75"	10.75"	5.75"	Damp
60-7175	5 Lt. Chandelier	Brushed Nickel Clear Glass	5	A19	Med.	60W	•	24"	13.5"	•	Dry
60-7176	5 Lt. Island Pendant	Brushed Nickel Clear Glass	5	A19	Med.	60W	38.5"	4.5"	8.75"	•	Dry
60-7177	3 Lt. Pendant	Brushed Nickel Clear Glass	3	B10	Cand.	60W	•	11.75"	12.88"	•	Dry
60-7178	3 Lt. Semi-Flush	Brushed Nickel Clear Glass	3	A19	Med.	60W	•	11.75"	13.5"	•	Dry
60-7179	9 Lt. Chandelier	Brushed Nickel Clear Glass	9	A19	Med.	60W	•	30"	22"	•	Dry
60-7268	2 Lt. Flush Mount	Matte Black Clear Glass	2	A19	Med.	60W	•	12.88"	5.63"	•	Damp
60-7269	3 Lt. Flush Mount	Matte Black Clear Glass	3	A19	Med.	60W	•	15"	5.63"	•	Damp
60-7270	1 Lt. Mini Pendant	Matte Black Clear Glass	1	A19	Med.	60W	•	4.75"	8.25"	•	Dry
60-7271	1 Lt. Vanity	Matte Black Clear Glass	1	A19	Med.	60W	•	4.63"	10.75"	5.75"	Damp
60-7272	2 Lt. Vanity	Matte Black Clear Glass	2	A19	Med.	60W	•	15"	10.75"	5.75"	Damp
60-7273	3 Lt. Vanity	Matte Black Clear Glass	3	A19	Med.	60W	•	21"	10.75"	5.75"	Damp
60-7274	4 Lt. Vanity	Matte Black Clear Glass	4	A19	Med.	60W	•	29.75"	10.75"	5.75"	Damp
60-7275	5 Lt. Chandelier	Matte Black Clear Glass	5	A19	Med.	60W	•	24"	13.5"	•	Dry
60-7276	5 Lt. Island Pendant	Matte Black Clear Glass	5	A19	Med.	60W	38.5"	4.5"	8.75"	•	Dry
60-7277	3 Lt. Pendant	Matte Black Clear Glass	3	B10	Cand.	60W	•	11.75"	12.88"	•	Dry
60-7278	3 Lt. Semi-Flush	Matte Black Clear Glass	3	A19	Med.	60W	•	11.75"	13.5"	•	Dry
60-7279	9 Lt. Chandelier	Matte Black Clear Glass	9	A19	Med.	60W	•	30"	22"	•	Dry

Additional chain: Brushed Nickel (3') 25-1069, Black (3') 25-475

Additional Stems: Brushed Nickel (6") 25-2047, (12") 25-2021, Matte Black (6") 25-465 (12") 25-466

Pendant conversion kit for semi flush: Brushed Nickel 25-1403, Matte Black 25-3035.

(2) x 6" Stems and (2) x 12" Stems Included

Vanities: CUL listed for up or down installation

Chandeliers, Semi flush and Pendants: 12' of wire supplied

## FINISH OPTIONS



Matte Black  
Clear Glass



Brushed Nickel  
Clear Glass



60-7269 - 15" W (shown)  
Matte Black



60-7168 - 13" W (shown)  
Brushed Nickel



60-7179 - 30" W (shown)  
Brushed Nickel



60-7170 - 5" W (shown)  
Brushed Nickel

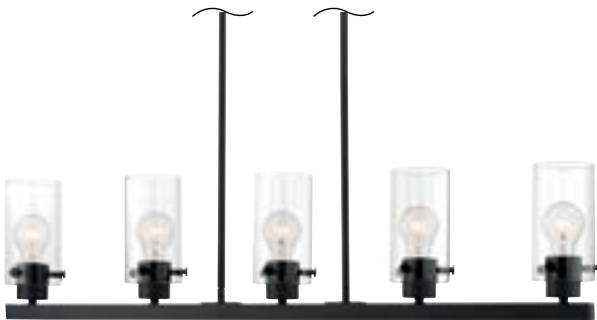

60-7276 - 39" W (shown)  
Matte Black



60-7277 - 12" W (shown)  
Matte Black



60-7174 - 30" W (shown)  
Brushed Nickel



60-7278 - 12" W (shown)  
Matte Black



# BRANSEL

Effortlessly blending elegance and charm, the Bransel collection is beautiful with its sleek, streamlined design. Seeded glass goblet shades beautifully accenting the Brushed Nickel finish. Its inviting warmth of modern farmhouse style, wherever it shines Bransel fills your space with a soft, romantic glow.

ITEM	DESCRIPTION	FINISH	NO. OF LIGHTS	LAMP TYPE	BASE	MAX WATTS	LENGTH	WIDTH	HEIGHT	EXT.	CERT. TYPE
60-7180	1 Lt. Mini Pendant	Brushed Nickel Clear Seeded Glass	1	A19	Med.	60W	•	5"	7.25"	•	Dry
60-7181	1 Lt. Sconce/Vanity	Brushed Nickel Clear Seeded Glass	1	A19	Med.	60W	•	4.88"	8.88"	5.5"	Damp
60-7182	2 Lt. Vanity	Brushed Nickel Clear Seeded Glass	2	A19	Med.	60W	•	12"	8.88"	5.5"	Damp
60-7183	3 Lt. Vanity	Brushed Nickel Clear Seeded Glass	3	A19	Med.	60W	•	20"	8.88"	5.5"	Damp
60-7184	4 Lt. Vanity	Brushed Nickel Clear Seeded Glass	4	A19	Med.	60W	•	28"	8.88"	5.5"	Damp
60-7185	5 Lt. Chandelier	Brushed Nickel Clear Seeded Glass	5	A19	Med.	60W	•	25"	17.63"	•	Dry
60-7186	5 Lt. Island Pendant	Brushed Nickel Clear Seeded Glass	5	A19	Med.	60W	36.25"	4.5"	7.38"	•	Dry
60-7187	3 Lt. Pendant	Brushed Nickel Clear Seeded Glass	3	B10	Cand.	60W	•	11.75"	12.88"	•	Dry
60-7188	3 Lt. Semi-Flush	Brushed Nickel Clear Seeded Glass	3	A19	Med.	60W	•	11.75"	14"	•	Dry
60-7189	9 Lt. Chandelier	Brushed Nickel Clear Seeded Glass	9	A19	Med.	60W	•	28"	25"	•	Dry
60-7190	2 Lt. Flush Mount	Brushed Nickel Clear Seeded Glass	2	A19	Med.	60W	•	12.88"	6.25"	•	Damp
60-7191	3 Lt. Flush Mount	Brushed Nickel Clear Seeded Glass	3	A19	Med.	60W	•	15"	6.75"	•	Damp
60-7280	1 Lt. Mini Pendant	Matte Black Clear Seeded Glass	1	A19	Med.	60W	•	5"	7.25"	•	Dry
60-7281	1 Lt. Vanity	Matte Black Clear Seeded Glass	1	A19	Med.	60W	•	4.88"	8.88"	5.5"	Damp
60-7282	2 Lt. Vanity	Matte Black Clear Seeded Glass	2	A19	Med.	60W	•	12"	8.88"	5.5"	Damp
60-7283	3 Lt. Vanity	Matte Black Clear Seeded Glass	3	A19	Med.	60W	•	20"	8.88"	5.5"	Damp
60-7284	4 Lt. Vanity	Matte Black Clear Seeded Glass	4	A19	Med.	60W	•	28"	8.88"	5.5"	Damp
60-7285	5 Lt. Chandelier	Matte Black Clear Seeded Glass	5	A19	Med.	60W	•	25"	17.63"	•	Dry
60-7286	5 Lt. Island Pendant	Matte Black Clear Seeded Glass	5	A19	Med.	60W	36.25"	4.5"	7.38"	•	Dry
60-7287	3 Lt. Pendant	Matte Black Clear Seeded Glass	3	B10	Cand.	60W	•	11.75"	12.88"	•	Dry
60-7288	3 Lt. Semi-Flush	Matte Black Clear Seeded Glass	3	A19	Med.	60W	•	11.75"	14"	•	Dry
60-7289	9 Lt. Chandelier	Matte Black Clear Seeded Glass	9	A19	Med.	60W	•	28"	25"	•	Dry
60-7290	2 Lt. Flush Mount	Matte Black Clear Seeded Glass	2	A19	Med.	60W	•	12.88"	6.25"	•	Damp
60-7291	3 Lt. Flush Mount	Matte Black Clear Seeded Glass	3	A19	Med.	60W	•	15"	6.75"	•	Damp

Additional chain: Brushed Nickel (3') 25-1069, Black (3') 25-475. Vanities can be mounted up or down

Additional Stems: (Brushed Nickel): (6") 25-2047, (12") 25-2021, (Matte Black) (6") 25-465 (12") 25-466

Pendant conversion kit for semi flush: (Brushed Nickel): 25-1403, (Matte Black): 25-3033

(2) x 6" Stems and (2) x 12" Stems Included

Vanities: CUL listed for up or down installation

Chandeliers, Semi flush and Pendants: 12' of wire supplied

## FINISH OPTIONS



Matte Black  
Clear Seeded Glass



Brushed Nickel  
Clear Seeded Glass



60-7191 - 15" W (shown)  
Brushed Nickel



60-7290 - 13" W (shown)  
Matte Black



60-7189 - 28" W (shown)  
Brushed Nickel



60-7180 - 5" W (shown)  
Brushed Nickel



60-7286 - 36" W (shown)  
Matte Black



60-7287 - 12" W (shown)  
Matte Black



60-7284 - 28" W (shown)  
Matte Black



60-7188 - 12" W (shown)  
Brushed Nickel



# LAGUNA

The Laguna series is a sophisticated lighting solution for inside the home. Illuminating beautifully with its contemporary and elegant design, adds style to any home decor.

ITEM	DESCRIPTION	FINISH	NO. OF LIGHTS	LAMP TYPE	BASE	MAX WATTS	LENGTH	WIDTH	HEIGHT	EXT.	CERT. TYPE
60-5821	1 Lt. Sconce/Vanity	Brushed Nickel Frosted Glass	1	A19	Med.	100W	•	5.13"	8.5"	7.38"	Damp
60-5822	2 Lt. Vanity	Brushed Nickel Frosted Glass	2	A19	Med.	100W	•	16"	9"	6.5"	Damp
60-5823	3 Lt. Vanity	Brushed Nickel Frosted Glass	3	A19	Med.	100W	•	24"	9"	6.5"	Damp
60-5824	3 Lt. Flush Mount	Brushed Nickel Frosted Glass	3	A19	Med.	60W	•	15.13"	6.75"	•	Damp
60-5825	5 Lt. Chandelier	Brushed Nickel Frosted Glass	5	A19	Med.	100W	•	23"	17.13"	•	Dry
60-5826	2 Lt. Semi-Flush	Brushed Nickel Frosted Glass	2	A19	Med.	60W	•	15.25"	10.63"	•	Dry
60-5827	4 Lt. Pendant	Brushed Nickel Frosted Glass	4	A19	Med.	60W	•	19.5"	22.38"	•	Dry
60-5828	1 Lt. Mini Pendant	Brushed Nickel Frosted Glass	1	A19	Med.	100W	•	5.13"	7.88"	•	Dry
60-5874	4 Lt. Vanity	Brushed Nickel Frosted Glass	4	A19	Med.	100W	•	33"	9"	6.5"	Damp
60-5875	4 Lt. Island Pendant	Brushed Nickel Frosted Glass	4	A19	Med.	60W	33"	5.13"	8.63"	•	Dry
60-5876	4 Lt. Caged Pendant	Brushed Nickel Frosted Glass	4	B11	Cand.	60W	•	14"	22.75"	•	Dry
60-5921	1 Lt. Sconce/Vanity	Forest Bronze Frosted Glass	1	A19	Med.	100W	•	5.13"	8.5"	7.38"	Damp
60-5922	2 Lt. Vanity	Forest Bronze Frosted Glass	2	A19	Med.	100W	•	16"	9"	6.5"	Damp
60-5923	3 Lt. Vanity	Forest Bronze Frosted Glass	3	A19	Med.	100W	•	24"	9"	6.5"	Damp
60-5924	3 Lt. Flush Mount	Forest Bronze Frosted Glass	3	A19	Med.	60W	•	15.13"	6.75"	•	Damp
60-5925	5 Lt. Chandelier	Forest Bronze Frosted Glass	5	A19	Med.	100W	•	23"	17.13"	•	Dry
60-5926	2 Lt. Semi-Flush	Forest Bronze Frosted Glass	2	A19	Med.	60W	•	15.25"	10.63"	•	Dry
60-5927	4 Lt. Pendant	Forest Bronze Frosted Glass	4	A19	Med.	60W	•	19.5"	22.38"	•	Dry
60-5928	1 Lt. Mini Pendant	Forest Bronze Frosted Glass	1	A19	Med.	100W	•	5.13"	7.88"	•	Dry
60-5974	4 Lt. Vanity	Forest Bronze Frosted Glass	4	A19	Med.	100W	•	33"	9"	6.5"	Damp
60-5975	4 Lt. Island Pendant	Forest Bronze Frosted Glass	4	A19	Med.	60W	33"	5.13"	8.63"	•	Dry
60-5976	4 Lt. Caged Pendant	Forest Bronze Frosted Glass	4	B11	Cand.	60W	•	14"	22.75"	•	Dry

Additional chain: Brushed Nickel (3') 25-1069, Forest Bronze (3') 25-5924

Additional Stems: Brushed Nickel (6") 25-2057, (12") 25-2055, Forest Bronze (6") 25-5976, (12") 25-5977

(2) x 6" Stems and (2) x 12" Stems Included

Vanities: CUL listed for up or down installation

Pendant conversion kit: Brushed Nickel 25-3067, Forest Bronze 25-5926

Chandeliers and Pendant: 12' of wire and 4' of chain supplied

## FINISH OPTIONS



Forest Bronze  
Frosted Glass



Brushed Nickel  
Frosted Glass



60-5874- 33" W (shown)  
Brushed Nickel



60-5821 - 5" W (shown)  
Brushed Nickel



60-5976 - 14" W (shown)  
Forest Bronze



60-5925 - 23" W (shown)  
Forest Bronze



60-5827 - 20" W (shown)  
Brushed Nickel



60-5875 - 33" W (shown)  
Brushed Nickel



60-5828 - 5" W (shown)  
Brushed Nickel



60-5824 - 15" W (shown)  
Brushed Nickel



60-5926 - 15" W (shown)  
Forest Bronze



# WILLOW

The Willow collection brings a touch of refined elegance to your home, perfect for brightening your living spaces. This stunning series blends contemporary design and timeless charm, effortlessly enhancing any décor, making every space feel more stylish and sophisticated.

ITEM	DESCRIPTION	FINISH	NO. OF LIGHTS	LAMP TYPE	BASE	MAX WATTS	WIDTH	HEIGHT	EXT.	CERT. TYPE
60-5801	1 Lt. Vanity	Polished Nickel White Glass	1	A19	Med.	100W	4.38"	8.63"	8"	Damp
60-5802	2 Lt. Vanity	Polished Nickel White Glass	2	A19	Med.	100W	14"	8"	8"	Damp
60-5803	3 Lt. Vanity	Polished Nickel White Glass	3	A19	Med.	100W	23"	8"	8"	Damp
60-5804	2 Lt. Flush Mount	Polished Nickel White Glass	2	A19	Med.	60W	13.5"	5.5"	•	Damp
60-5805	5 Lt. Chandelier	Polished Nickel White Glass	5	A19	Med.	100W	27"	21"	•	Dry
60-5806	2 Lt. Semi-Flush*	Polished Nickel White Glass	2	A19	Med.	60W	13"	8"	•	Dry
60-5807	4 Lt. Pendant	Polished Nickel White Glass	4	A19	Med.	60W	18"	17.63"	•	Dry
60-5808	1 Lt. Mini Pendant	Polished Nickel White Glass	1	A19	Med.	100W	3.88"	8.63"	•	Dry
60-5871	4 Lt. Vanity	Polished Nickel White Glass	4	A19	Med.	100W	34"	8.25"	8"	Damp

Additional chain: (3') 25-4141

(2) x 6" Stems and (2) x 12" Stems Included

Pendant conversion kit for semi-flush: 25-4143

Vanities: CUL listed for up or down installation

Chandelier and pendants: 12' of wire and 4' chain supplied



60-5801 - 5" W



60-5802 - 14" W



60-5803 - 23" W

## FINISH



Polished Nickel  
White Glass



60-5871 - 34" W



60-5805 - 27" W



60-5807 - 18" W



60-5808 - 4" W



60-5804 - 14" W



60-5806 - 13" W



# SURREY

The Surrey collection was created to find that perfect style that can cross the boundaries between traditional and contemporary design. The curved lines follow the path of traditional fixtures, and easily finds itself at home in many styles.

ITEM	DESCRIPTION	FINISH	NO. OF LIGHTS	LAMP TYPE	BASE	MAX WATTS	WIDTH	HEIGHT	EXT.	CERT. TYPE
60-4141	1 Lt. Sconce/Vanity	Brushed Nickel Frosted Glass	1	A19	Med.	100W	6"	8"	7"	Damp
60-4142	2 Lt. Vanity	Brushed Nickel Frosted Glass	2	A19	Med.	100W	16"	10.25"	6.75"	Damp
60-4143	3 Lt. Vanity	Brushed Nickel Frosted Glass	3	A19	Med.	100W	23.75"	10.25"	6.75"	Damp
60-4145	3 Lt. Chandelier	Brushed Nickel Frosted Glass	3	A19	Med.	60W	21.75"	24"	•	Dry
60-4147	3 Lt. Pendant	Brushed Nickel Frosted Glass	3	A15	Med.	60W	15.75"	21"	•	Dry
60-4148	1 Lt. Mini Pendant	Brushed Nickel Frosted Glass	1	A19	Med.	100W	6"	33"	•	Dry
60-4151	3 Lt. Semi-Flush	Brushed Nickel Frosted Glass	3	A19	Med.	60W	13"	10"	•	Dry
60-4152	2 Lt. Sm. Flush Mount	Brushed Nickel Frosted Glass	2	A19	Med.	60W	13"	7"	•	Damp
60-4153	3 Lt. Lg. Flush Mount	Brushed Nickel Frosted Glass	3	A19	Med.	60W	15.5"	8.75"	•	Damp

Additional chain: (3') 25-1069

Additional Stems: (6") 25-2057, (12") 25-2055

(2) x 6" Stems and (2) x 12" Stems Included

Pendant conversion kit for semi-flush: 25-1403

Sconce/Vanities: CUL listed for up or down installation

Chandelier and Pendants: 12' of wire and 4' of chain supplied



60-4141 - 6" W



60-4142 - 16" W



60-4143 - 24" W

## FINISH



Brushed Nickel  
Frosted Glass



60-4145 - 22" W



60-4147 - 16" W



60-4148 - 6" W



60-4153 - 16" W (shown)



60-4151 - 13" W

# PATTON

Illuminate your world with the timeless elegance of the Patton series, where classic inspiration meets modern allure. Create an ambiance of romance, a touch of magic, inviting warmth and beauty wherever they are placed.

ITEM	DESCRIPTION	FINISH	NO. OF LIGHTS	LAMP TYPE	BASE	MAX WATTS	WIDTH	HEIGHT	EXT.	CERT. TYPE
60-5031	1 Lt. Vanity	Brushed Nickel Frosted Glass	1	A19	Med.	100W	5.5"	11"	8"	Damp
60-5032	2 Lt. Vanity	Brushed Nickel Frosted Glass	2	A19	Med.	100W	15"	10"	7"	Damp
60-5033	3 Lt. Vanity	Brushed Nickel Frosted Glass	3	A19	Med.	100W	21"	10"	7.5"	Damp
60-5034	4 Lt. Vanity	Brushed Nickel Frosted Glass	4	A19	Med.	100W	28"	11"	7.5"	Damp
60-5035	5 Lt. Up Chandelier	Brushed Nickel Frosted Glass	5	A19	Med.	60W	25"	20"	•	Dry
60-5036	3 Lt. Up Chandelier	Brushed Nickel Frosted Glass	3	A19	Med.	60W	21"	23"	•	Dry
60-5037	1 Lt. Mini Pendant	Brushed Nickel Frosted Glass	1	A19	Med.	60W	5.13"	11.38"	•	Dry
60-5038	3 Lt. Pendant	Brushed Nickel Frosted Glass	3	A19	Med.	60W	16"	21"	•	Dry
60-5041	3 Lt. Flush Mount	Brushed Nickel Frosted Glass	3	A19	Med.	60W	15.75"	7.75"	•	Damp
60-5042	3 Lt. Down Chandelier	Brushed Nickel Frosted Glass	3	A19	Med.	60W	21"	19"	•	Dry
60-5043	5 Lt. Down Chandelier	Brushed Nickel Frosted Glass	5	A19	Med.	60W	25"	20"	•	Dry
60-5044	3 Lt. Semi-Flush*	Brushed Nickel Frosted Glass	3	A19	Med.	60W	13"	11"	•	Dry
60-5131	1 Lt. Vanity	Prairie Bronze Frosted Glass	1	A19	Med.	60W	5.5"	11"	8"	Damp
60-5132	2 Lt. Vanity	Prairie Bronze Frosted Glass	2	A19	Med.	100W	15"	10"	7"	Damp
60-5133	3 Lt. Vanity	Prairie Bronze Frosted Glass	3	A19	Med.	100W	21"	10"	7.5"	Damp
60-5134	4 Lt. Vanity	Prairie Bronze Frosted Glass	4	A19	Med.	100W	28"	11"	7.5"	Damp
60-5135	5 Lt. Up Chandelier	Prairie Bronze Frosted Glass	5	A19	Med.	100W	25"	20"	•	Dry
60-5137	1 Lt. Mini Pendant	Prairie Bronze Frosted Glass	1	A19	Med.	60W	5.13"	11.38"	•	Dry
60-5138	3 Lt. Pendant	Prairie Bronze Frosted Glass	3	A19	Med.	60W	16"	21"	•	Dry
60-5141	3 Lt. Flush Mount	Prairie Bronze Frosted Glass	3	A19	Med.	60W	15.75"	7.75"	•	Damp
60-5143	5 Lt. Down Chandelier	Prairie Bronze Frosted Glass	5	A19	Med.	60W	25"	20"	•	Dry
60-5144	3 Lt. Semi-Flush*	Prairie Bronze Frosted Glass	3	A19	Med.	60W	13"	11"	•	Dry

Additional chain: Bronze (3') 25-0531 | Additional Stems: Brushed Nickel (6") 25-2047, (12") 25-2021, Prairie Bronze (6") 25-4208, (12") 25-4209

(2) x 6" Stems and (2) x 12" Stems Included

Pendant conversion kit: for semi-flush: Prairie Bronze 25-4211, Brushed Nickel 25-1403

Vanities: CUL listed for up or down installation

Pendants Chandeliers: 12' of wire and 4' of chain supplied

## FINISH OPTIONS



Prairie Bronze  
Frosted Glass



Brushed Nickel  
Frosted Glass



60-5131 - 6" W (shown)  
Prairie Bronze



60-5034 - 28" W (shown)  
Brushed Nickel



60-5035 - 25" W (shown)  
Brushed Nickel



60-5042 - 21" W (shown)  
Brushed Nickel



60-5038 - 16" W (shown)  
Brushed Nickel



60-5137 - 6" W (shown)  
Prairie Bronze



60-5144 - 13" W (shown)  
Prairie Bronze



60-5041 - 16" W (shown)  
Brushed Nickel



# LAKE

The Lake series enchants with its elegant design that is showcased by a simple frame and clean lines. Perfect for making a captivating statement with your home's lighting and beautifully combines form and function.

## FINISH OPTIONS



Iron Black w/  
Brushed Nickel  
Accents

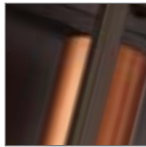

Forest Bronze w/  
Copper Accents



60-5856 - 8" W (shown)  
Iron Black w/  
Brushed Nickel Accents

ITEM	DESCRIPTION	FINISH	NO. OF LIGHTS	LAMP TYPE	BASE	MAX WATTS	LENGTH	WIDTH	HEIGHT	EXT.	CERT. TYPE
60-5851	1Lt. Sconce/Vanity	Forest Bronze w/ Copper Accents	1	ST19	Med.	60W	•	8"	12"	4.5"	Damp
60-5854	4 Lt. Island Pendant	Forest Bronze w/ Copper Accents	4	ST19	Med.	60W	36"	10"	11.25"	•	Dry
60-5855	1Lt. Mini Pendant	Forest Bronze w/ Copper Accents	1	ST19	Med.	60W	8.13"	8.13"	13.75"	•	Dry
60-5856	1Lt. Sconce/Vanity	Iron Black w/ Br. Nickel Accents	1	ST19	Med.	60W	•	8"	12"	4.5"	Damp
60-5859	4 Lt. Island Pendant	Iron Black w/ Br. Nickel Accents	4	ST19	Med.	60W	36"	10"	11.25"	•	Dry
60-5860	1Lt. Mini Pendant	Iron Black /w Br. Nickel Accents	1	ST19	Med.	60W	8.13"	8.13"	13.75"	•	Dry

Additional Stems: Iron Black (6") 25-5858, (12") 25-5859, Forest Bronze (6") 25-5976, (12") 25-5977

(2) x 6" Stems and (2) x 12" Stems Included

Sconce/Vanities: CUL listed for up or down installation

Pendants: 12' of wire supplied



60-5855 - 8" W (shown)

Forest Bronze w/  
Copper Accents



60-5859 - 36" L (shown)

Iron Black w/  
Brushed Nickel Accents



ST19 Vintage  
lamps included



# GINGER

The Ginger Collection exudes timeless elegance, blending classic style with a modern allure that speaks to chic sophistication. The fixture's are a masterpiece of graceful lines that capture the eye and invite admiration. Cast a warm, inviting glow that transforms your space into a haven of comfort and beauty.

## FINISH OPTIONS



Brushed Nickel  
Etched Opal Glass



Old Bronze  
Etched Opal Glass



60-5335 - 14" W (shown)  
Old Bronze

ITEM	DESCRIPTION	FINISH	NO. OF LIGHTS	LAMP TYPE	BASE	MAX WATTS	WIDTH	HEIGHT	CERT. TYPE
60-5331	2 Lt. Semi-Flush	Brushed Nickel Etched Opal Glass	2	A19	Med.	100W	14"	8.25"	Dry
60-5332	1Lt. Mini Pendant	Brushed Nickel Etched Opal Glass	1	A19	Med.	100W	8"	13.88"	Dry
60-5333	3 Lt. Pendant	Brushed Nickel Etched Opal Glass	3	A19	Med.	100W	16"	17"	Dry
60-5335	2 Lt. Semi-Flush	Old Bronze Etched Opal Glass	2	A19	Med.	100W	14"	8.25"	Dry
60-5336	1Lt. Mini Pendant	Old Bronze Etched Opal Glass	1	A19	Med.	100W	8"	8.25"	Dry
60-5337	3 Lt. Pendant	Old Bronze Etched Opal Glass	3	A19	Med.	100W	16"	17"	Dry

Additional chain: Old Bronze (3') 25-1067, Additional Stems: (6") 25-2028, (12") 25-2002,

Pendant conversion kit for semi-flush: 25-1402

Additional chain: Brushed Nickel (3') 25-1069, Additional Stems: (6") 25-2047, (12") 25-2021.

Pendant conversion kit for semi-flush: 25-1403

(2) x 6" Stems and (2) x 12" Stems Included

Pendants and Semi-flush: 12' of wire and 4' of chain supplied



60-5333 - 16" W (shown)  
Brushed Nickel



60-5336 - 8" W (shown)  
Old Bronze



# DUPONT

Dupont is an affordable collection which offers quality and style. Fine details that are finely crafted with great attention to construction are evident throughout. An unassuming series that fits a variety of styles and home décors.

ITEM	DESCRIPTION	FINISH	NO. OF LIGHTS	LAMP TYPE	BASE	MAX WATTS	WIDTH	HEIGHT	EXT.	CERT. TYPE
60-1822	5 Lt. Chandelier	Brushed Nickel Satin White Glass	5	A19	Med.	60W	22"	5.75"	•	Dry
60-1824	1 Lt. Flush Mount	Brushed Nickel Satin White Glass	1	A19	Med.	60W	11"	7"	•	Damp
60-1825	2 Lt. Flush Mount	Brushed Nickel Satin White Glass	2	A19	Med.	60W	13"	7"	•	Damp
60-1828	3 Lt. Pendant	Brushed Nickel Satin White Glass	3	A19	Med.	60W	16"	20"	•	Dry
60-1831	1 Lt. Mini Pendant	Brushed Nickel Satin White Glass	1	A19	Med.	60W	6"	7.5"	•	Dry
60-1834	3 Lt. Vanity	Brushed Nickel Satin White Glass	3	A19	Med.	60W	24"	8"	7.75"	Damp
60-1835	4 Lt. Vanity	Brushed Nickel Satin White Glass	4	A19	Med.	60W	30"	8"	7.75"	Damp

Additional chain: (3') 25-1069 | Additional Stems: Brushed Nickel (6") 25-2047, (12") 25-2021  
 (2) x 6" Stems and (2) x 12" Stems Included  
 Vanities: CUL listed for up or down installation  
 Pendants: 12' of wire and 4' of chain supplied



60-1828 - 16" W



60-1822 - 22" W

## FINISH



Brushed Nickel  
Satin White Glass



60-1834 - 24" W



60-1835 - 30" W

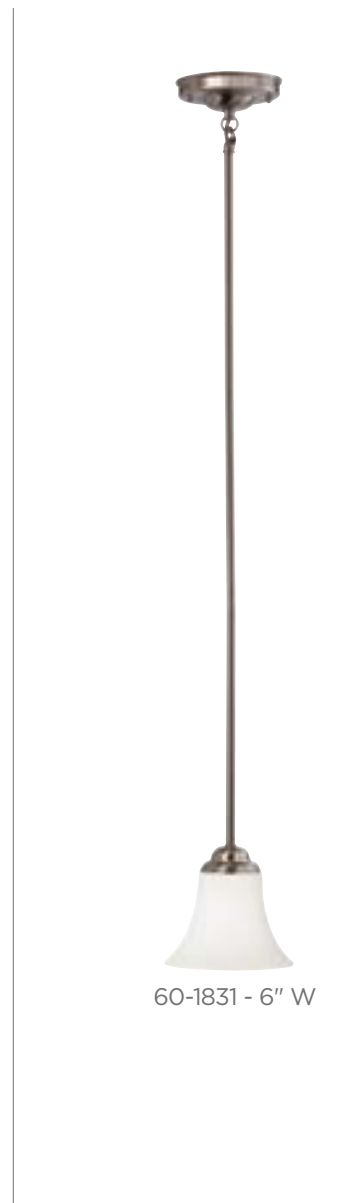

60-1831 - 6" W



# POLARIS

Inspired by the romance of the sea, the Polaris collection captures the timeless charm of a coastal retreat, yet its elegance blends beautifully with any style. Effortlessly captivating, illuminate an entryway, hallway, or bedroom with Polaris—a touch of light at its most enchanting.

ITEM	DESCRIPTION	FINISH	NO. OF LIGHTS	LAMP TYPE	BASE	MAX WATTS	WIDTH	HEIGHT	EXT.	CERT. TYPE
60-608	2 Lt. Flush	Brushed Nickel Satin Frosted Glass	2	A19	Med.	60W	13.5"	4.88"	•	Damp
60-609	2 Lt. Semi-Flush	Brushed Nickel Satin Frosted Glass	2	A19	Med.	60W	13.75"	8"	•	Dry
60-611	1 Lt. Sconce/Vanity	Brushed Nickel Satin Frosted Glass	1	A19	Med.	100W	4.5"	8.25"	8"	Damp
60-612	2 Lt. Vanity	Brushed Nickel Satin Frosted Glass	2	A19	Med.	100W	13.5"	8.25"	8"	Damp
60-613	3 Lt. Vanity	Brushed Nickel Satin Frosted Glass	3	A19	Med.	100W	21"	8.25"	8"	Damp
60-614	4 Lt. Vanity	Brushed Nickel Satin Frosted Glass	4	A19	Med.	100W	29.75"	8.25"	8"	Damp
60-615	Mini Pendant	Brushed Nickel Satin Frosted Glass	1	A19	Med.	60W	5.13"	8.88"	•	Dry

Additional Stems: (6") 25-2057, (12") 25-2055  
 (2) x 6" Stems and (2) x 12" Stems Included  
 Pendant conversion kit for semi-flush: 25-1431  
 Vanities: CUL listed for up or down installation  
 Pendant and semi-flush: 12' of wire supplied



60-614 - 30" W (shown)



60-609 - 14" W



60-615 - 5" W

## FINISH



Brushed Nickel  
Satin Frosted Glass



60-608 - 14" W

# PARALLEL

Nuvo's Parallel vanity collection is refined sophistication for your home's interior. Seamlessly adapting to your style, enhancing any décor with its clean lines and understated elegance.



ITEM	DESCRIPTION	FINISH	NO. OF LIGHTS	LAMP TYPE	BASE	MAX WATTS	WIDTH	HEIGHT	EXT.	CERT. TYPE
60-5201	1 Lt. Sconce/Vanity	Polished Nickel Etched Opal Glass	1	A19	Med.	100W	5"	12.5"	8.75"	Damp
60-5202	2 Lt. Vanity	Polished Nickel Etched Opal Glass	2	A19	Med.	100W	13"	7.75"	8.75"	Damp
60-5203	3 Lt. Vanity	Polished Nickel Etched Opal Glass	3	A19	Med.	100W	21"	7.75"	8.75"	Damp
60-5204	4 Lt. Vanity	Polished Nickel Etched Opal Glass	4	A19	Med.	100W	29"	7.75"	8.75"	Damp
60-5207	3 Lt. Flush Mount	Polished Nickel Etched Opal Glass	3	A19	Med.	60W	15"	6.5"	•	Damp
60-5301	1 Lt. Vanity	Aged Bronze Etched Opal Glass	1	A19	Med.	100W	5"	12.5"	8.75"	Damp
60-5302	2 Lt. Vanity	Aged Bronze Etched Opal Glass	2	A19	Med.	100W	13"	7.75"	8.75"	Damp
60-5303	3 Lt. Vanity	Aged Bronze Etched Opal Glass	3	A19	Med.	100W	21"	7.75"	8.75"	Damp
60-5304	4 Lt. Vanity	Aged Bronze Etched Opal Glass	4	A19	Med.	100W	29"	7.75"	8.75"	Damp
60-5307	3 Lt. Flush Mount	Aged Bronze Etched Opal Glass	3	A19	Med.	60W	15"	6.5"	•	Damp

Vanities: CUL listed for up or down installation



60-5201 - 5" W (shown)  
Polished Nickel



60-5304 - 29" W (shown)  
Aged Bronze

## FINISH OPTIONS



Polished Nickel  
Etched Opal Glass

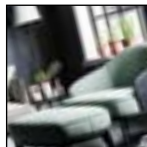

Aged Bronze  
Etched Opal Glass



60-5207 - 15" W (shown)  
Polished Nickel



# MOBILI

The Mobili collection offers an elegant lighting solution for any home interior. Contemporary and versatile, this series effortlessly adds a touch of style to your homes interior.

ITEM	DESCRIPTION	FINISH	NO. OF LIGHTS	LAMP TYPE	BASE	MAX WATTS	WIDTH	HEIGHT	EXT.	CERT. TYPE
60-5450	2 Lt. Semi-Flush	Brushed Nickel Satin White Glass	2	A19	Med.	60W	13.13"	10.25"	•	Dry
60-5451	1 Lt. Sconce/Vanity	Brushed Nickel Satin White Glass	1	A19	Med.	100W	5.88"	8.13"	6.88"	Damp
60-5452	2 Lt. Vanity	Brushed Nickel Satin White Glass	2	A19	Med.	100W	15.38"	7.88"	6.88"	Damp
60-5453	3 Lt. Vanity	Brushed Nickel Satin White Glass	3	A19	Med.	100W	25"	7.88"	6.88"	Damp
60-5454	4 Lt. Vanity	Brushed Nickel Satin White Glass	4	A19	Med.	100W	34.63"	7.88"	6.88"	Damp
60-5457	1 Lt. Mini Pendant	Brushed Nickel Satin White Glass	1	A19	Med.	100W	5.88"	11.13"	•	Dry
60-5460	2 Lt. Flush Mount	Brushed Nickel Satin White Glass	2	A19	Med.	60W	13.13"	5.13"	•	Damp

Additional Stems: (6") 25-2047, (12") 25-2021

(2) x 6" Stems and (2) x 12" Stems Included

Pendant conversion kit for semi-flush: 25-1403

Sconce/Vanities: CUL listed for up or down installation  
Mini pendant, and semi-flush fixtures; 12' of wire supplied



60-5460 - 13" W



60-5460 - 13" W



60-5457 - 6" W

## FINISH



Brushed Nickel  
Satin White Glass

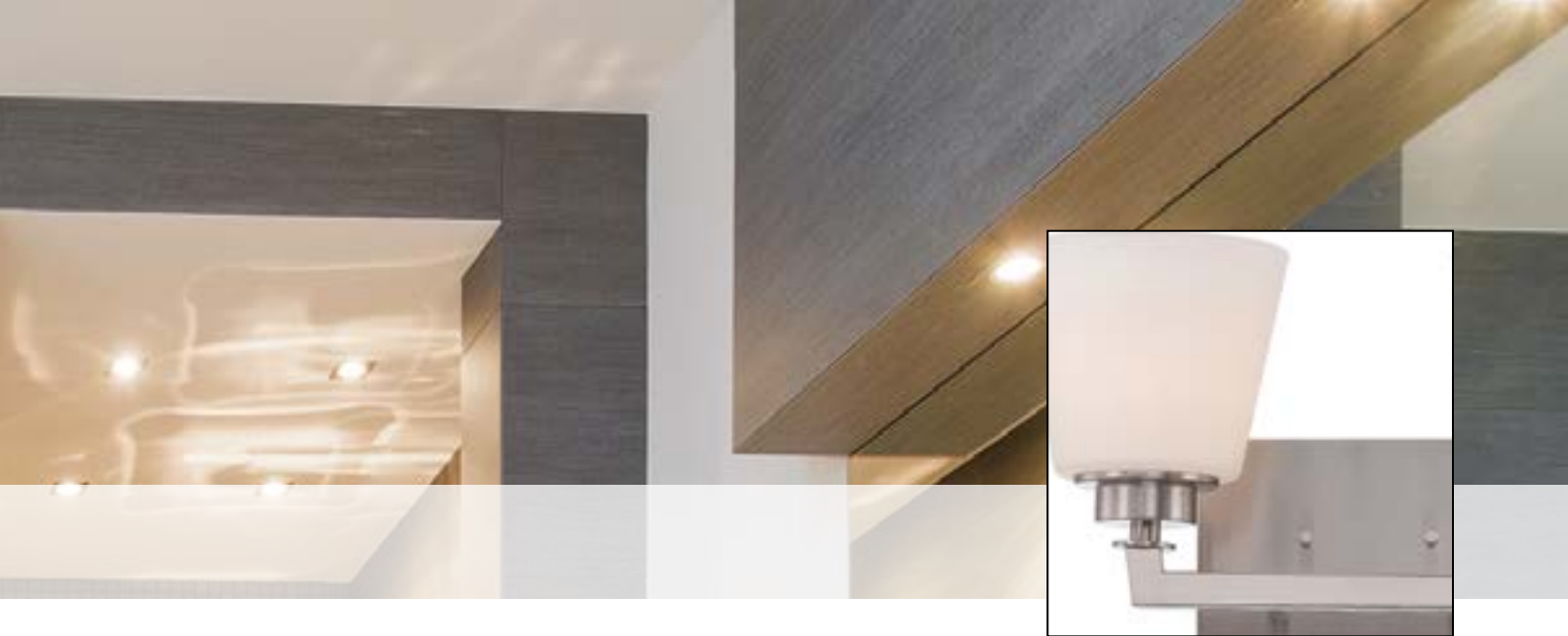

60-5451 - 6" W



60-5452 - 15" W



60-5453 - 25" W



60-5454 - 35" W

# SOHO

Introducing the Soho Collection, a contemporary lighting design that exudes understated elegance. Soho adds a touch of modern sophistication without overwhelming your space. Perfect for today's home, this exquisite fixture creates a serene and stylish ambiance, enhancing your home with its subtle charm.



ITEM	DESCRIPTION	FINISH	NO. OF LIGHTS	LAMP TYPE	BASE	MAX WATTS	WIDTH	HEIGHT	EXT.	CERT. TYPE
60-4581	1 Lt. Sconce/Vanity	Polished Chrome Satin White Glass	1	A19	Med.	100W	7"	8.25"	8"	Damp
60-4582	2 Lt. Vanity	Polished Chrome Satin White Glass	2	A19	Med.	100W	16"	7.25"	8"	Damp
60-4583	3 Lt. Vanity	Polished Chrome Satin White Glass	3	A19	Med.	100W	25"	7.25"	8"	Damp
60-4584	4 Lt. Vanity	Polished Chrome Satin White Glass	4	A19	Med.	100W	34"	7.25"	8"	Damp
60-4588	1 Lt. Mini Pendant	Polished Chrome Satin White Glass	1	A19	Med.	60W	7"	6.88"	•	Dry
60-4591	2 Lt. Flush Mount	Polished Chrome Satin White Glass	2	A19	Med.	60W	15.38"	8"	•	Damp
60-4593	2 Lt. Semi-Flush	Polished Chrome Satin White Glass	2	A19	Med.	60W	13"	10.13"	•	Damp

Additional Stems: (6") 25-2062, (12") 25-2061

(2) x 6" Stems and (2) x 12" Stems Included

Pendant conversion kit for semi-flush: 25-4143

Vanities: CUL listed for up or down installation

Pendant and Semi-Flush fixtures: 12' of wire supplied



60-4584 - 34" W



60-4583 - 25" W



60-4581 - 7" W

## FINISH



Polished Chrome  
Satin White Glass



60-4593 - 13" W



60-4591 - 15" W



60-4588 - 7" W



# DECKER

Decker is a meticulously crafted, featuring finely machined components that showcase its thoughtful design. Complementing a wide range of contemporary elements, bringing a refined touch to any setting.

ITEM	DESCRIPTION	FINISH	NO. OF LIGHTS	LAMP TYPE	BASE	MAX WATTS	WIDTH	HEIGHT	EXT.	CERT. TYPE
60-4641	1 Lt. Sconce/Vanity	Brushed Nickel Clear and Frosted Glass	1	A19	Med.	100W	5.75"	10.25"	6.75"	Damp
60-4642	2 Lt. Vanity	Brushed Nickel Clear and Frosted Glass	2	A19	Med.	100W	13.75"	10.25"	6.75"	Damp
60-4643	3 Lt. Vanity	Brushed Nickel Clear and Frosted Glass	3	A19	Med.	100W	21.75"	10.25"	6.75"	Damp
60-4644	4 Lt. Vanity	Brushed Nickel Clear and Frosted Glass	4	A19	Med.	100W	29.75"	10.25"	6.75"	Damp
60-4648	1 Lt. Mini Pendant	Brushed Nickel Clear and Frosted Glass	1	A19	Med.	60W	6"	8.63"	•	Dry
60-4651	2 Lt. Flush Mount	Brushed Nickel Clear and Frosted Glass	2	A19	Med.	60W	13"	7"	•	Damp

Additional Stems: (6") 25-2057, (12") 25-2055  
 (2) x 6" Stems and (2) x 12" Stems Included  
 Vanities: CUL listed for up or down installation  
 Pendant: 12' of wire supplied



60-4642 - 14" W



60-4643 - 22" W



60-4644 - 30" W



60-4651 - 13" W



60-4648 - 6" W

## FINISH



Brushed Nickel  
Clear and  
Frosted Glass

# GLACIER

The Glacier Collection is comprised of contemporary elements and rich finishes. Bring panache to your powder room with a pair of sconces or spruce up that entry way with the flush mount; superb style for your home's illumination.



ITEM	DESCRIPTION	FINISH	NO. OF LIGHTS	LAMP TYPE	BASE	MAX WATTS	WIDTH	HEIGHT	EXT.	CERT. TYPE
60-7810	2 Lt. Flush Mount	Matte Black Iced Glass	2	T10	Med.	60W	13"	5.63"	•	Damp
60-7811	1 Lt. Vanity	Matte Black Iced Glass	1	T10	Med.	60W	4.38"	10.63"	4.88"	Damp
60-7812	2 Lt. Vanity	Matte Black Iced Glass	2	T10	Med.	60W	22"	4.38"	4.88"	Damp
60-7813	3 Lt. Vanity	Matte Black Iced Glass	3	T10	Med.	60W	34"	4.38"	4.88"	Damp

Vanities: CUL listed for horizontal or vertical installation



60-7812 - 22" W



60-7813 - 34" W



60-7810 - 13" W

## FINISH



Matte Black Iced Glass



60-7811 - 5" W



# PARKER

The Parker collection takes the best of prairie style design and thrusts it forward to a modern sleek interpretation. Truly a contemporary classic, Parker's gleaming Polished Chrome finish with Sandstone etched glass shades make this family a must have for many applications.

ITEM	DESCRIPTION	FINISH	NO. OF LIGHTS	LAMP TYPE	BASE	MAX WATTS	WIDTH	HEIGHT	EXT.	CERT. TYPE
60-4001	1 Lt. Sconce / Vanity	Polished Chrome Sandstone Etched Glass	1	A19	Med.	100W	4.75"	9.5"	6.38"	Damp
60-4002	2 Lt. Vanity	Polished Chrome Sandstone Etched Glass	2	A19	Med.	100W	11.25"	9.5"	6.38"	Damp
60-4003	3 Lt. Vanity	Polished Chrome Sandstone Etched Glass	3	A19	Med.	100W	18.75"	9.5"	6.38"	Damp
60-4004	4 Lt. Vanity	Polished Chrome Sandstone Etched Glass	4	A19	Med.	100W	26"	9.5"	6.38"	Damp
60-5373	1 Lt. Sconce	Polished Chrome Sandstone Etched Glass	1	A19	Med.	60W	13"	6.75"	6.5"	Damp

Vanities: CUL listed for up or down installation



60-4001 - 5" W



60-4002 - 11" W



60-4003 - 19" W



60-5373 - 13" W



60-4004 - 26" W

## FINISH



Polished Chrome  
Sandstone Etched Glass

# VISTA

Vista vanity fixtures bring sleek sophistication to any home. These contemporary fixture casts a warm, inviting glow. Stylish and refined, in living rooms, dining areas, bathrooms, and foyers alike. Stylish and refined, the Vista vanity light effortlessly elevates any decor with its modern elegance.



ITEM	DESCRIPTION	FINISH	NO. OF LIGHTS	LAMP TYPE	BASE	MAX WATTS	WIDTH	HEIGHT	EXT.	CERT. TYPE
60-5181	1 Lt. Sconce /Vanity	Polished Nickel Etched Opal Glass	1	A19	Med.	100W	4.5"	8"	5.38"	Damp
60-5182	2 Lt. Vanity	Polished Nickel Etched Opal Glass	2	A19	Med.	100W	15.5"	8"	5.38"	Damp
60-5183	3 Lt. Vanity	Polished Nickel Etched Opal Glass	3	A19	Med.	100W	23.38"	8"	5.38"	Damp
60-5184	4 Lt. Vanity	Polished Nickel Etched Opal Glass	4	A19	Med.	100W	32.38"	8"	5.38"	Damp

Vanities: CUL listed for up or down installation



60-5181 - 5" W



60-5182 - 16" W



60-5183 - 23" W



60-5184 - 32" W

## FINISH



Polished Nickel  
Etched Opal Glass



# JESS LED

Unassuming yet elegant is the best way to describe Jess, exuding sophistication with a minimalist style. Delivering energy-efficient, this sleek vanity light blends perfectly with surrounding decor and is as functional as it is magnificent.

ITEM	DESCRIPTION	FINISH	LIGHT SOURCE	WATTS	WIDTH	HEIGHT	EXT.	CCT	LUMENS	CRI	CERT. TYPE
62-1330	Sconce / Vanity	Brushed Nickel White Acrylic Lens	LED	13W	12.5"	4.5"	2"	3000K	910	90	Damp
62-1331	25" Vanity	Brushed Nickel White Acrylic Lens	LED	26W	25"	4.5"	2"	3000K	1820	90	Damp
62-1332	36" Vanity	Brushed Nickel White Acrylic Lens	LED	39W	36"	4.5"	2"	3000K	2730	90	Damp



CUL listed for horizontal or vertical installation  
ADA compliant



62-1330 - 13" W



62-1331 - 25" W



62-1332 - 36" W

## FINISH



Brushed Nickel  
White Acrylic Lens

# BEND LED

Simple yet elegant is the best way to describe the Bend collection. Exuding sophistication with a minimalist design, blending perfectly with surrounding decor and is as functional as it is stylish.

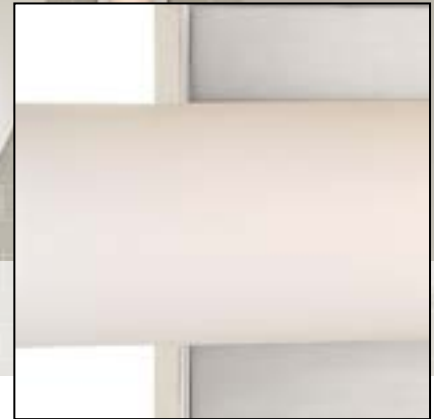

ITEM	DESCRIPTION	FINISH	LIGHT SOURCE	WATTS	WIDTH	HEIGHT	EXT.	CCT	LUMENS	CRI	CERT. TYPE
62-1321	13" Sconce / Vanity	Brushed Nickel White Acrylic Lens	LED	13W	13"	4.5"	3"	3000K	910	90	Damp
62-1322	26" Vanity	Brushed Nickel White Acrylic Lens	LED	26W	25.5"	4.5"	3"	3000K	1820	90	Damp
62-1323	36" Vanity	Brushed Nickel White Acrylic Lens	LED	39W	36.25"	4.5"	3"	3000K	2730	90	Damp



CUL listed for horizontal or vertical installation

ADA Compliant

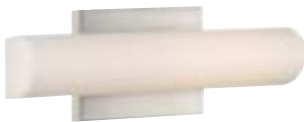

62-1321 - 13" W



62-1322 - 26" W



62-1323- 36" W

## FINISH



Brushed Nickel  
White Acrylic Lens



# LOOP LED

The Loop single LED wall sconce is an understated lighting solution for inside the home. Illuminate living rooms, dining rooms, bathrooms, and foyers with this elegant, integrated LED delivering warm white light.

ITEM	DESCRIPTION	FINISH	LIGHT SOURCE	WATTS	WIDTH	HEIGHT	EXT.	CCT	LUMENS	CRI	CERT. TYPE
62-921	12" Sconce	Brushed Nickel White Acrylic Lens	LED	13W	4"	12"	3.13"	3000K	1040	90	Damp
62-922	24" Vanity	Brushed Nickel White Acrylic Lens	LED	26W	24"	4"	3.13"	3000K	2080	90	Damp
62-923	12" Sconce	Aged Bronze White Acrylic Lens	LED	13W	4"	12"	3.13"	3000K	1040	80	Damp
62-924	24" Vanity	Aged Bronze White Acrylic Lens	LED	26W	24"	4"	3.13"	3000K	2080	80	Damp
62-925	36" Vanity	Brushed Nickel White Acrylic Lens	LED	39W	36"	4"	3.13"	3000K	3120	90	Damp
62-926	36" Vanity	Aged Bronze White Acrylic Lens	LED	39W	36"	4"	3.13"	3000K	3120	80	Damp



Vanities: CUL listed for horizontal or vertical installation  
 Sconces: CUL listed for up or down installation  
 ADA compliant



62-924 - 24" W (shown)  
Aged Bronze



62-925 - 36" W (shown)  
Brushed Nickel

## FINISH



Brushed Nickel  
White Acrylic Lens



Aged Bronze  
White Acrylic Lens



62-921 - 12" Ht (shown)  
Brushed Nickel

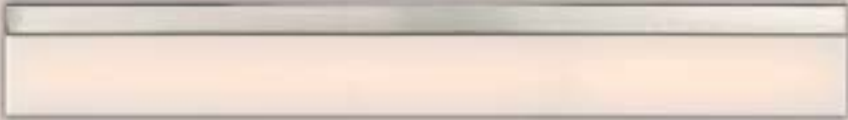

# JACKSON LED

A sleek and dazzling contemporary style with the Jackson collection, LED lighting illuminating with a pleasing modern glow that is sure to add a comforting contemporary look to your bath or vanity area.

ITEM	DESCRIPTION	FINISH	LIGHT SOURCE	WATTS	WIDTH	HEIGHT	EXT.	CCT	LUMENS	CRI	CERT. TYPE
62-1327	Sconce / Vanity	Brushed Nickel White Acrylic Lens	LED	13W	12.5"	4.5"	2"	3000K	910	90	Damp
62-1328	25" Vanity	Brushed Nickel White Acrylic Lens	LED	26W	24"	4.5"	2"	3000K	1820	90	Damp
62-1329	36" Vanity	Brushed Nickel White Acrylic Lens	LED	39W	35.5"	4.5"	2"	3000K	2730	90	Damp



CUL listed for optional up or down installation  
ADA compliant



62-1327 - 13" W



62-1328 - 24" W



62-1329 - 36" W

## FINISH

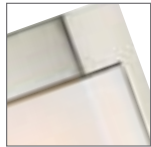

Brushed Nickel  
White Acrylic Lens



# BOW LED

Bow wall sconces combine simplicity with elegance, bringing a touch of modern sophistication to any space. Offering a minimalist beauty that feels effortlessly refined, add a gentle, radiant touch that's as charming as it is functional.

ITEM	DESCRIPTION	FINISH	LIGHT SOURCE	WATTS	WIDTH	HEIGHT	EXT.	CCT	LUMENS	CRI	CERT. TYPE
62-1081	20" Vanity	Brushed Nickel White Acrylic Lens	LED	13W	20"	4.25"	2.75"	3000K	1040	90	Damp
62-1082	31" Vanity	Brushed Nickel White Acrylic Lens	LED	26W	31"	4.25"	3.31"	3000K	2080	90	Damp
62-1083	43" Vanity	Brushed Nickel White Acrylic Lens	LED	39W	43"	4.25"	3.31"	3000K	3120	90	Damp



CUL listed for horizontal or vertical installation  
ADA Compliant



62-1081 - 20" W



62-1082 - 31" W



62-1083 - 43" W

## FINISH



Brushed Nickel  
White Acrylic Lens

# GRILL LED



Aptly named, Grill features a style all it's own with simplicity and elan. The elongated shape adds drama and the overlapping bands are what give it it's namesake. Theatrical lighting to bring a modern elegance to any area of your home.

ITEM	DESCRIPTION	FINISH	LIGHT SOURCE	WATTS	WIDTH	HEIGHT	EXT.	CCT	LUMENS	CRI	CERT. TYPE
62-871	Sconce / Vanity	Polished Nickel White Acrylic Lens	LED	13W	4"	12"	3"	3000K	1040	90	Damp
62-872	24" Vanity	Polished Nickel White Acrylic Lens	LED	26W	24"	4"	3"	3000K	2080	90	Damp
62-873	Sconce / Vanity	Aged Bronze White Acrylic Lens	LED	13W	4"	12"	3"	3000K	1040	80	Damp
62-874	24" Vanity	Aged Bronze White Acrylic Lens	LED	26W	24"	4"	3"	3000K	2080	80	Damp
62-875	36" Vanity	Polished Nickel White Acrylic Lens	LED	39W	36"	4"	3"	3000K	3120	90	Damp
62-876	36" Vanity	Aged Bronze White Acrylic Lens	LED	39W	36"	4"	3"	3000K	3120	80	Damp



CUL listed for horizontal or vertical installation

ADA compliant



62-873 - 4" W (shown)  
Aged Bronze



62-872 - 24" W (shown)  
Polished Nickel

## FINISH OPTIONS



Polished Nickel  
White Acrylic Lens

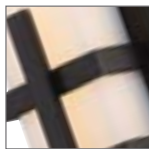

Aged Bronze  
White Acrylic Lens



62-876 - 36" W (shown)  
Aged Bronze



# SLICK LED

As its namesake implies, the Slick vanity collection is a stylish and sleek lighting solution for today's home. Its simple structure boasts enormous appeal and is accompanied by energy-saving LED technology.

ITEM	DESCRIPTION	FINISH	LIGHT SOURCE	WATTS	WIDTH	HEIGHT	EXT.	CCT	LUMENS	CRI	CERT. TYPE
62-1101	13" Sconce/Vanity	Polished Nickel White Acrylic Lens	LED	13W	13"	4.5"	2.88"	3000K	1040	90	Damp
62-1102	25" Vanity	Polished Nickel White Acrylic Lens	LED	26W	25"	4.5"	2.88"	3000K	2080	90	Damp
62-1103	36" Vanity	Polished Nickel White Acrylic Lens	LED	39W	36"	4.5"	2.88"	3000K	3120	90	Damp



CUL listed for horizontal or vertical installation

ADA Compliant



62-1101 - 13" W



62-1102 - 25" W

## FINISH



Polished Nickel  
White Acrylic Lens



62-1103 - 36" W



# SLICE LED

The modern refinement of the Slice vanity collection takes stylish simplicity to greater heights. It's no-nonsense form suits various home design styles, making it a sophisticated addition to your home's lighting.

ITEM	DESCRIPTION	FINISH	LIGHT SOURCE	WATTS	WIDTH	HEIGHT	EXT.	CCT	LUMENS	CRI	CERT. TYPE
62-931	12" Sconce	Polished Nickel White Acrylic Lens	LED	13W	4.5"	12"	3"	3000K	1040	90	Damp
62-932	24" Vanity	Polished Nickel White Acrylic Lens	LED	26W	24"	4.5"	3"	3000K	2080	90	Damp
62-933	12" Sconce	Aged Bronze White Acrylic Lens	LED	13W	4.5"	12"	3"	3000K	1040	80	Damp
62-934	24" Vanity	Aged Bronze White Acrylic Lens	LED	26W	24"	4.5"	3"	3000K	2080	80	Damp
62-935	36" Vanity	Polished Nickel White Acrylic Lens	LED	39W	36"	4.5"	3"	3000K	3120	90	Damp
62-936	36" Vanity	Aged Bronze White Acrylic Lens	LED	39W	36"	4.5"	3"	3000K	3120	80	Damp



CUL listed for horizontal or vertical installation  
ADA compliant



62-932 - 24" W (shown)  
Polished Nickel



62-936 - 36" W (shown)  
Aged Bronze



62-933 - 12" Ht (shown)  
Aged Bronze

## FINISH OPTIONS



Polished Nickel  
White Acrylic Lens



Aged Bronze  
White Acrylic Lens



# JENKINS LED

Elevate your bathroom space with the Jenkins Vanity Collection, a stunning blend of transitional and modern design. Redefine your bathroom with exceptional craftsmanship and enduring design.

ITEM	DESCRIPTION	FINISH	LIGHT SOURCE	WATTS	WIDTH	HEIGHT	EXT.	CCT	LUMENS	CRI	CERT TYPE
62-2242	16" 2 Lt. Vanity	Matte Black Frosted White Lens	LED	10W	15.5"	4.5"	4.75"	3000K	960	90	Damp
62-2243	24" 3 Lt. Vanity	Matte Black Frosted White Lens	LED	15W	24"	4.5"	4.75"	3000K	1440	90	Damp
62-2244	33" 4 Lt. Vanity	Matte Black Frosted White Lens	LED	20W	32.5"	4.5"	4.75"	3000K	1920	90	Damp
62-2252	16" 2 Lt. Vanity	Brushed Nickel Frosted White Lens	LED	10W	15.5"	4.5"	4.75"	3000K	960	90	Damp
62-2253	24" 3 Lt. Vanity	Brushed Nickel Frosted White Lens	LED	15W	24"	4.5"	4.75"	3000K	1440	90	Damp
62-2254	33" 4 Lt. Vanity	Brushed Nickel Frosted White Lens	LED	20W	32.5"	4.5"	4.75"	3000K	1920	90	Damp



CUL listed for horizontal or vertical installation



62-2252 - 16" W (shown)  
Brushed Nickel



62-2243 - 24" W (shown)  
Matte Black

## FINISH OPTIONS



Matte Black  
Frosted White Lens



Brushed Nickel  
Frosted White Lens



62-2254 - 33" W (shown)  
Brushed Nickel



# CANAL LED

Whether you're looking to update your bathroom vanity area or create a modern and sleek ambiance in your powder room, the Canal integrated LED bathroom lights are an excellent choice. The perfect choice for any bathroom setting.

ITEM	DESCRIPTION	FINISH	LIGHT SOURCE	WATTS	WIDTH	HEIGHT	EXT.	CCT	LUMENS	CRI	CERT. TYPE
62-1541	Sm. Vanity	Brushed Nickel w/ White Acrylic Lens	LED	13W	12"	4.75"	4.13"	3000K	1040	90	Damp
62-1542	Med. Vanity	Brushed Nickel w/ White Acrylic Lens	LED	26W	24"	4.75"	4.13"	3000K	2080	90	Damp
62-1543	Lg. Vanity	Brushed Nickel w/ White Acrylic Lens	LED	39W	36"	4.75"	4.13"	3000K	3120	90	Damp
62-666	Sm. Vanity	Matte Black w/ White Acrylic Lens	LED	13W	12"	4.75"	4.13"	3000K	1040	90	Damp
62-668	Med. Vanity	Matte Black w/ White Acrylic Lens	LED	26W	24"	4.75"	4.13"	3000K	2080	90	Damp
62-669	Lg. Vanity	Matte Black w/ White Acrylic Lens	LED	39W	36"	4.75"	4.13"	3000K	3120	90	Damp

CUL listed for horizontal or vertical installation



62-666 - 12" W (shown)  
Matte Black



62-668 - 24" W (shown)  
Matte Black



62-1543 - 36" W (shown)  
Brushed Nickel

## FINISH OPTIONS



Brushed Nickel w/  
White Acrylic Lens



Matte Black w/  
White Acrylic Lens



# SOLANO LED

The design of the Solano series is sleek and minimalist, with a simple yet elegant shape. Update a powder room or master bathroom with these stunning vanity lights.

ITEM	DESCRIPTION	FINISH	LIGHT SOURCE	WATTS	WIDTH	HEIGHT	EXT.	CCT	LUMENS	CRI	CERT. TYPE
62-1537	Sm. Vanity	Black Brushed Brass & White Acrylic Lens	LED	13W	12"	4.25"	4.25"	3000K	1040	90	Damp
62-1538	Med. Vanity	Black Brushed Brass & White Acrylic Lens	LED	26W	24"	4.25"	4.25"	3000K	2080	90	Damp
62-1539	Lg. Vanity	Black Brushed Brass & White Acrylic Lens	LED	39W	36"	4.25"	4.25"	3000K	3120	90	Damp
62-656	Sm. Vanity	Black Brushed Nickel & White Acrylic Lens	LED	13W	12"	4.25"	4.25"	3000K	1040	90	Damp
62-658	Med. Vanity	Black Brushed Nickel & White Acrylic Lens	LED	26W	24"	4.25"	4.25"	3000K	2080	90	Damp
62-659	Lg. Vanity	Black Brushed Nickel & White Acrylic Lens	LED	39W	36"	4.25"	4.25"	3000K	3120	90	Damp

CUL listed for horizontal or vertical installation



62-656 - 12" W (shown)  
Brushed Nickel



62-1539 - 36" W (shown)  
Brushed Brass

## FINISH OPTIONS

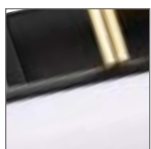

Black  
Brushed Brass &  
White Acrylic Lens



Black  
Brushed Nickel &  
White Acrylic Lens



# BOWMAN LED

A modern design that seamlessly blends form and function to elevate your space, the Bowman Collection is crafted to perfection with its alluring contemporary style. Whether you're redesigning your living space or creating a statement in a professional environment, this collection is your go-to choice for chic lighting.

## FINISH OPTIONS



Matte Black  
White Acrylic



Brushed Nickel  
White Acrylic



62-2213 - 36" W (shown)  
Brushed Nickel

ITEM	DESCRIPTION	FINISH	LIGHT SOURCE	WATTS	LENGTH	WIDTH	HEIGHT	EXT.	CCT	LUMENS	CRI	CERT TYPE
62-2201	12" Vanity	Matte Black White Acrylic	LED	13W	•	12"	4.5"	3.88"	3000K	1105	90	Damp
62-2202	24" Vanity	Matte Black White Acrylic	LED	26W	•	24"	4.5"	3.63"	3000K	2210	90	Damp
62-2203	36" Vanity	Matte Black White Acrylic	LED	39W	•	35.88"	4.5"	3.63"	3000K	3315	90	Damp
62-2211	12" Vanity	Brushed Nickel White Acrylic	LED	13W	•	12"	4.5"	3.88"	3000K	1105	90	Damp
62-2212	24" Vanity	Brushed Nickel White Acrylic	LED	26W	•	24"	4.5"	3.63"	3000K	2210	90	Damp
62-2213	36" Vanity	Brushed Nickel White Acrylic	LED	39W	•	35.88"	4.5"	3.63"	3000K	3315	90	Damp
62-2271	36" Island Pendant	Matte Black White Acrylic	LED	39W	35.88"	2"	1.75"	•	3000K	3315	90	Dry
62-2272	36" Island Pendant	Brushed Nickel White Acrylic	LED	39W	35.88"	2"	1.75"	•	3000K	3315	90	Dry



Additional Stems: Matte Black (6") 25-479, (12") 25-480, Brushed Nickel (6") 25-2047, (12") 25-2021

(2) x 6" Stems and (2) x 12" Stems Included

Vanities: CUL listed for horizontal or vertical installation

Vanities: ADA Compliant

Island Pendants: 12' of Wire Supplied



62-2203 - 36" W (shown)  
Matte Black



62-2271 - 36" L (shown)  
Matte Black

# KAGEN LED



The Kagen series is a stylish and modern set of lighting fixtures. Whether you're looking to update your bathroom vanity area or create a modern and sleek ambiance in your powder room, the Kagen Collection is an excellent choice.

ITEM	DESCRIPTION	FINISH	LIGHT SOURCE	WATTS	WIDTH	HEIGHT	EXT.	CCT	LUMENS	CRI	CERT. TYPE
62-1534	Sm. Vanity	Brushed Nickel White Acrylic Lens	LED	13W	13.58"	5"	3.25"	3000K	1040	90	Damp
62-1535	Med. Vanity	Brushed Nickel White Acrylic Lens	LED	26W	25.58"	5"	3.25"	3000K	2080	90	Damp
62-1536	Lg. Vanity	Brushed Nickel White Acrylic Lens	LED	39W	37.58"	5"	3.25"	3000K	3120	90	Damp
62-676	Sm. Vanity	Matte Black White Acrylic Lens	LED	13W	13.58"	5"	3.25"	3000K	1040	90	Damp
62-678	Med. Vanity	Matte Black White Acrylic Lens	LED	26W	25.58"	5"	3.25"	3000K	2080	90	Damp
62-679	Lg. Vanity	Matte Black White Acrylic Lens	LED	39 W	37.58"	5"	3.25"	3000K	3120	90	Damp



CUL listed for horizontal or vertical installation

ADA Compliant



62-676 - 14" W (shown)  
Matte Black



62-678 - 26" W (shown)  
Matte Black



62-1536 - 38" W (shown)  
Brushed Nickel

## FINISH OPTIONS



Brushed Nickel  
White Acrylic Lens



Matte Black  
White Acrylic Lens



# EDGEWORTH LED

The Edgeworth LED Vanity Light is subtle, timeless elegance designed with a bold, statement-making aesthetic. Experience the perfect synergy of form and function, as this luminaire seamlessly integrates into your space while elevating its visual appeal.

ITEM	DESCRIPTION	FINISH	LIGHT SOURCE	WATTS	WIDTH	HEIGHT	EXT.	CCT	LUMENS	CRI	CERT TYPE
62-2221	16" Vanity	Matte Black White Acrylic Glass	LED	13W	15.75"	4.5"	4.13"	3000K	1105	90	Damp
62-2222	28" Vanity	Matte Black White Acrylic Glass	LED	26W	27.75"	4.5"	4.13"	3000K	2210	90	Damp
62-2223	40" Vanity	Matte Black White Acrylic Glass	LED	39W	39.63"	4.5"	4.13"	3000K	3315	90	Damp
62-2231	16" Vanity	Brushed Nickel White Acrylic Glass	LED	13W	15.75"	4.5"	4.13"	3000K	1105	90	Damp
62-2232	28" Vanity	Brushed Nickel White Acrylic Glass	LED	26W	27.75"	4.5"	4.13"	3000K	2210	90	Damp
62-2233	40" Vanity	Brushed Nickel White Acrylic Glass	LED	39W	39.63"	4.5"	4.13"	3000K	3315	90	Damp



CUL listed for horizontal or vertical installation



62-2221 - 16" W (shown)  
Matte Black



62-2232 - 28" W (shown)  
Brushed Nickel



62-2233 - 40" W (shown)  
Brushed Nickel

## FINISH OPTIONS



Brushed Nickel  
White Acrylic Lens



Matte Black  
White Acrylic Lens



# BOND LED

Bring a touch of refined modern design with Bond, a glowing piece of lighting sure to brighten any bathroom suite. Combining lasting beauty with sophistication, enhancing your home decor with effortless style.

## FINISH OPTIONS



Brushed Nickel  
White Acrylic Lens



Polished Nickel  
White Acrylic Lens



Aged Bronze  
White Acrylic Lens



62-731 - 10" Ht (shown)  
Brushed Nickel

ITEM#	DESCRIPTION	FINISH	LIGHT SOURCE	WATTS	WIDTH	HEIGHT	EXT.	CCT	LUMENS	CRI	CERT. TYPE
62-721	Sconce	Polished Nickel / White Acrylic Lens	LED	10W	6"	9.5"	4"	3000K	850	90	Damp
62-722	Sconce / Vanity	Polished Nickel / White Acrylic Lens	LED	20W	6"	17.5"	4"	3000K	1580	90	Damp
62-723	Lg. Sconce	Polished Nickel / White Acrylic Lens	LED	13W	6"	19.5"	4"	3000K	1040	90	Damp
62-724	Vanity	Polished Nickel / White Acrylic Lens	LED	36W	6"	37.38"	4"	3000K	2880	90	Damp
62-731	Sconce	Brushed Nickel / White Acrylic Lens	LED	10W	6"	9.5"	4"	3000K	850	90	Damp
62-732	Sconce / Vanity	Brushed Nickel / White Acrylic Lens	LED	20W	6"	17.5"	4"	3000K	1580	90	Damp
62-733	Lg. Sconce	Brushed Nickel / White Acrylic Lens	LED	13W	6"	19.5"	4"	3000K	1040	90	Damp
62-734	Vanity	Brushed Nickel / White Acrylic Lens	LED	36W	6"	37.38"	4"	3000K	2880	90	Damp
62-741	Sconce	Aged Bronze / White Acrylic Lens	LED	10W	6"	9.5"	4"	3000K	850	90	Damp
62-742	Sconce / Vanity	Aged Bronze / White Acrylic Lens	LED	20W	6"	17.5"	4"	3000K	1580	90	Damp
62-743	Lg. Sconce	Aged Bronze / White Acrylic Lens	LED	13W	6"	19.5"	4"	3000K	1040	90	Damp
62-744	Vanity	Aged Bronze / White Acrylic Lens	LED	36W	6"	37.38"	4"	3000K	2880	90	Damp



Sconce / Vanities: CUL listed for horizontal or vertical installation

Sconces: CUL listed for up or down installation

ADA compliant



62-742 - 18" Ht (shown)  
Aged Bronze



62-743 - 20" Ht (shown)  
Aged Bronze

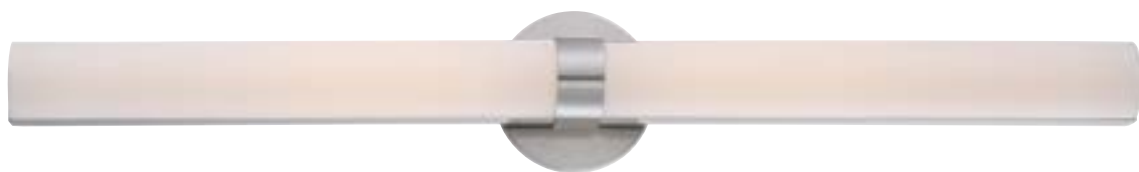

62-734 - 38" Ht (shown)  
Brushed Nickel



# LARISSA LED

Transform your bathroom into a haven of contemporary sophistication with the Larissa Collection, a stunning LED bath vanity bar that combines artistry and function. Sleek, slim, and unapologetically modern, Larissa redefines the standard for luxury lighting.

## FINISH OPTIONS



Black  
Opaque Glass



Brushed Nickel  
Opaque Glass



Vintage Brass  
Opaque Glass



62-2380 - 14" W (shown)  
Black

ITEM#	DESCRIPTION	FINISH	LIGHT SOURCE	WATTS	WIDTH	HEIGHT	EXT.	CCT	LUMENS	CRI	CERT. TYPE
62-2380	14" Vanity	Black Opaque Glass	LED	13W	14"	3.5"	4.75"	3000K	720	90	Damp
62-2381	14" Vanity	Brushed Nickel Opaque Glass	LED	13W	14"	3.5"	4.75"	3000K	720	90	Damp
62-2382	14" Vanity	Vintage Brass Opaque Glass	LED	13W	14"	3.5"	4.75"	3000K	720	90	Damp
62-2385	23" Vanity	Black Opaque Glass	LED	24W	23.25"	3.5"	4.75"	3000K	1840	90	Damp
62-2386	23" Vanity	Brushed Nickel Opaque Glass	LED	24W	23.25"	3.5"	4.75"	3000K	1840	90	Damp
62-2387	23" Vanity	Vintage Brass Opaque Glass	LED	24W	23.25"	3.5"	4.75"	3000K	1840	90	Damp
62-2390	32" Vanity	Black Opaque Glass	LED	33W	32"	3.5"	4.75"	3000K	2080	90	Damp
62-2391	32" Vanity	Brushed Nickel Opaque Glass	LED	33W	32"	3.5"	4.75"	3000K	2080	90	Damp
62-2392	32" Vanity	Vintage Brass Opaque Glass	LED	33W	32"	3.5"	4.75"	3000K	2080	90	Damp



Removable Backplate Knock Outs are removable  
 Vanities: CUL listed for horizontal or vertical installation  
 ADA compliant



62-2386 - 23" W (shown)  
 Brushed Nickel



62-2392 - 32" W (shown)  
 Vintage Brass



# BRIGHTWYN LED



Brings modern elegance to your bathroom with a design that's as versatile as it is captivating with the Brightwyn Collection. With its clean lines and minimalist aesthetic, it complements any décor, whether you're drawn to contemporary chic or understated luxury.

## FINISH OPTIONS



Matte Black



Brushed Brass



Brushed Nickel



62-2620 - 16" W (shown)  
Matte Black

ITEM#	DESCRIPTION	FINISH	LIGHT SOURCE	WATTS	WIDTH	HEIGHT	EXT.	CCT	LUMENS	CRI	CERT. TYPE
62-2620	16" Vanity	Matte Black	LED	13W	16"	4.38"	2.38"	3000K	1100	90	Damp
62-2630	16" Vanity	Brushed Brass	LED	13W	16"	4.38"	2.38"	3000K	1100	90	Damp
62-2640	16" Vanity	Brushed Nickel	LED	13W	16"	4.38"	2.38"	3000K	1100	90	Damp
62-2621	24" Vanity	Matte Black	LED	26W	24"	4.38"	2.38"	3000K	2100	90	Damp
62-2631	24" Vanity	Brushed Brass	LED	26W	24"	4.38"	2.38"	3000K	2100	90	Damp
62-2641	24" Vanity	Brushed Nickel	LED	26W	24"	4.38"	2.38"	3000K	2100	90	Damp
62-2622	35" Vanity	Matte Black	LED	39W	36.75"	4.38"	2.38"	3000K	3200	90	Damp
62-2632	35" Vanity	Brushed Brass	LED	39W	36.75"	4.38"	2.38"	3000K	3200	90	Damp
62-2642	35" Vanity	Brushed Nickel	LED	39W	36.75"	4.38"	2.38"	3000K	3200	90	Damp



Vanities: CUL listed for horizontal or vertical installation

ADA compliant



62-2631 - 24" W (shown)  
Brushed Brass



62-2642 - 37" W (shown)  
Brushed Nickel



# VELANO LED

3-CCT SELECTABLE - 3000K | 4000K | 5000K

Discover timeless grace with the Velano Collection, redefining contemporary lighting with a sophisticated blend of elegance and modernity. Its artful design and premium finishes make it more than a light, it's a statement of taste and individuality.

## FINISH OPTIONS



Brushed Brass/  
White Acrylic Lens



Brushed Nickel /  
White Acrylic Lens

ITEM#	DESCRIPTION	FINISH	LIGHT SOURCE	MAX WATTS	WIDTH	HEIGHT	EXT.	CCT	LUMENS	CRI	CERT. TYPE
62-2520	16" Vanity	Brushed Brass Wht. Acrylic Lens	LED	15W	17"	4"	3"	3000K/4000K/5000K	1200	90	Damp
62-2530	16" Vanity	Brushed Nickel Wht. Acrylic Lens	LED	15W	26"	4"	3"	3000K/4000K/5000K	1200	90	Damp
62-2521	24" Vanity	Brushed Brass Wht. Acrylic Lens	LED	24W	37.5"	4"	3"	3000K/4000K/5000K	1950	90	Damp
62-2531	24" Vanity	Brushed Nickel Wht. Acrylic Lens	LED	24W	17"	4"	3"	3000K/4000K/5000K	1950	90	Damp
62-2522	36" Vanity	Brushed Brass Wht. Acrylic Lens	LED	36W	26"	4"	3"	3000K/4000K/5000K	2900	90	Damp
62-2532	36" Vanity	Brushed Nickel Wht. Acrylic Lens	LED	36W	37.5"	4"	3"	3000K/4000K/5000K	2900	90	Damp

Vanities: CUL listed for horizontal or vertical installation  
 ADA compliant



62-2520 - 17" W (shown)  
 Brushed Brass



62-2531 - 26" W (shown)  
 Brushed Nickel



62-2532 - 36" W (shown)  
 Brushed Nickel



# LENA LED

A great design that is stylish and contemporary, the Lena vanity lights are spectacular. Brighten your bath or maybe a petite powder room where space might be limited, it is ideal for tight areas that require some much needed lighting improvements.

ITEM	DESCRIPTION	FINISH	LIGHT SOURCE	WATTS	WIDTH	HEIGHT	EXT.	CCT	LUMENS	CRI	CERT. TYPE
62-1591	Sconce / Vanity	Brushed Brass	LED	13W	12.5"	4.5"	3.25"	3000K	1105	90	Damp
62-1592	24" Vanity	Brushed Brass	LED	26W	24.38"	4.5"	3.25"	3000K	2210	90	Damp
62-1593	36" Vanity	Brushed Brass	LED	39W	35.63"	4.5"	3.25"	3000K	3315	90	Damp



CUL listed for horizontal or vertical installation

ADA compliant



62-1592 - 24" W  
Brushed Brass



62-1591 - 13" W



62-1593 - 36" W

## FINISH



Brushed Brass  
Striped Lens &  
Frosted Shade



# CAPER LED

The Caper vanity light is modern, contemporary style with a classic finish that transcends today's luminaires. It's rich finish and design combines timeless elegance within it's sleek, sophisticated package.

ITEM	DESCRIPTION	FINISH	LIGHT SOURCE	WATTS	WIDTH	HEIGHT	EXT.	CCT	LUMENS	CRI	CERT. TYPE
62-1601	Sconce / Vanity	Brushed Brass	LED	13W	12.75"	4.5"	3.63"	3000K	1105	90	Damp
62-1602	24" Vanity	Brushed Brass	LED	26W	24"	4.5"	3.63"	3000K	2210	90	Damp
62-1603	36" Vanity	Brushed Brass	LED	39W	35.63"	4.5"	3.63"	3000K	3315	90	Damp



CUL listed for horizontal or vertical installation  
 ADA compliant



62-1601 - 13" W



62-1602 - 24" W



62-1603 - 36" W

## FINISH



Brushed Brass  
 Frosted Acrylic Lens

# MERCER LED

Nuvo's Mercer LED vanity brings a touch of modern elegance and warmth to your home, casting a soft, inviting glow that elevates your bath to great heights. Perfect for brightening bathrooms, it bathes your surroundings in a cozy, lasting glow that feels as welcoming as it is beautiful.

ITEM	DESCRIPTION	FINISH	LIGHT SOURCE	WATTS	WIDTH	HEIGHT	EXT.	CCT	LUMENS	CRI	CERT. TYPE
62-311	1 Lt. Sconce / Vanity	Polished Nickel Frosted Glass	LED	10W	10"	4.13"	3.5"	3000K	850	90	Damp
62-312	2 Lt. Vanity	Polished Nickel Frosted Glass	LED	20W	20.5"	4.13"	3.5"	3000K	1700	90	Damp
62-313	3 Lt. Vanity	Polished Nickel Frosted Glass	LED	30W	27.88"	4"	3.5"	3000K	2550	90	Damp
62-314	1 Lt. Sconce / Vanity	Georgetown Bronze Frosted Glass	LED	10W	10"	4.13"	3.5"	3000K	850	90	Damp
62-315	2 Lt. Vanity	Georgetown Bronze Frosted Glass	LED	20W	20.5"	4.13"	3.5"	3000K	1700	90	Damp
62-316	3 Lt. Vanity	Georgetown Bronze Frosted Glass	LED	30W	27.88"	4"	3.5"	3000K	2550	90	Damp
62-317	1 Lt. Sconce / Vanity	Brushed Nickel Frosted Glass	LED	10W	10"	4.13"	3.5"	3000K	850	90	Damp
62-318	2 Lt. Vanity	Brushed Nickel Frosted Glass	LED	20W	20.5"	4.13"	3.5"	3000K	1700	90	Damp
62-319	3 Lt. Vanity	Brushed Nickel Frosted Glass	LED	30W	27.88"	4"	3.5"	3000K	2550	90	Damp



ADA compliant



62-311 - 10" W (shown)  
Polished Nickel

## FINISH OPTIONS



Polished Nickel  
Frosted Glass



Georgetown Bronze  
Frosted Glass



Brushed Nickel  
Frosted Glass



62-315 - 21" W (shown)  
Georgetown Bronze



62-319 - 28" W (shown)  
Brushed Nickel



# AUDEN LED

3-CCT SELECTABLE - 3000K | 4000K | 5000K

Elevate your space with the Auden Collection, where refined design and modern convenience come together. Crafted for those who appreciate both style and practicality, bring a touch of innovative elegance and ease to your home.

ROTATING  
FIXTURE BODY



## FINISH OPTIONS



Black  
Acrylic Lens



Brushed Nickel  
Acrylic Lens



Vintage Brass  
Acrylic Lens



62-2350 - 18" W (shown)  
Black

ITEM#	DESCRIPTION	FINISH	LIGHT SOURCE	WATTS	WIDTH	HEIGHT	EXT.	CCT	LUMENS	CRI	CERT. TYPE
62-2350	18" Vanity	Black Acrylic Lens	LED	15W	17.75"	5.5"	6"	3000K/4000K/5000K	1200	90	Damp
62-2351	18" Vanity	Brushed Nickel Acrylic Lens	LED	15W	17.75"	5.5"	6"	3000K/4000K/5000K	1200	90	Damp
62-2352	18" Vanity	Vintage Brass Acrylic Lens	LED	15W	17.75"	5.5"	6"	3000K/4000K/5000K	1200	90	Damp
62-2355	24" Vanity	Black Acrylic Lens	LED	20W	23.5"	5.5"	6"	3000K/4000K/5000K	1600	90	Damp
62-2356	24" Vanity	Brushed Nickel Acrylic Lens	LED	20W	23.5"	5.5"	6"	3000K/4000K/5000K	1600	90	Damp
62-2357	24" Vanity	Vintage Brass Acrylic Lens	LED	20W	23.5"	5.5"	6"	3000K/4000K/5000K	1600	90	Damp
62-2360	36" Vanity	Black Acrylic Lens	LED	35W	35.5"	5.5"	6"	3000K/4000K/5000K	2800	90	Damp
62-2361	36" Vanity	Brushed Nickel Acrylic Lens	LED	35W	35.5"	5.5"	6"	3000K/4000K/5000K	2800	90	Damp
62-2362	36" Vanity	Vintage Brass Acrylic Lens	LED	35W	35.5"	5.5"	6"	3000K/4000K/5000K	2800	90	Damp



62-2356 - 24" W (shown)  
Brushed Nickel



62-2362 - 36" W (shown)  
Vintage Brass



# CORA LED

3-CCT SELECTABLE - 3000K | 4000K | 5000K

Unveil the beauty of modern design with the Cora Collection, where every detail is crafted to perfection. Designed for those who appreciate both modern artistry and practical elegance, with contemporary craftsmanship and elevated style at its core.

## FINISH OPTIONS



Black  
Acrylic Lens



Brushed Nickel  
Acrylic Lens



Vintage Brass  
Acrylic Lens

ADJUSTABLE  
ARMS



62-2365 - 18" W (shown)  
Black

ITEM#	DESCRIPTION	FINISH	LIGHT SOURCE	WATTS	WIDTH	HEIGHT	EXT.	CCT	LUMENS	CRI	CERT. TYPE
62-2365	18" Vanity	Black Acrylic Lens	LED	15W	18.25"	4.75"	5"	3000K/4000K/5000K	1200	90	Damp
62-2366	18" Vanity	Brushed Nickel Acrylic Lens	LED	15W	18.25"	4.75"	5"	3000K/4000K/5000K	1200	90	Damp
62-2367	18" Vanity	Vintage Brass Acrylic Lens	LED	15W	18.25"	4.75"	5"	3000K/4000K/5000K	1200	90	Damp
62-2370	24" Vanity	Black Acrylic Lens	LED	20W	24.25"	4.75"	5"	3000K/4000K/5000K	1600	90	Damp
62-2371	24" Vanity	Brushed Nickel Acrylic Lens	LED	20W	24.25"	4.75"	5"	3000K/4000K/5000K	1600	90	Damp
62-2372	24" Vanity	Vintage Brass Acrylic Lens	LED	20W	24.25"	4.75"	5"	3000K/4000K/5000K	1600	90	Damp
62-2375	36" Vanity	Black Acrylic Lens	LED	35W	36"	4.75"	5"	3000K/4000K/5000K	2800	90	Damp
62-2376	36" Vanity	Brushed Nickel Acrylic Lens	LED	35W	36"	4.75"	5"	3000K/4000K/5000K	2800	90	Damp
62-2377	36" Vanity	Vintage Brass Acrylic Lens	LED	35W	36"	4.75"	5"	3000K/4000K/5000K	2800	90	Damp



62-2371 - 24" W (shown)  
Brushed Nickel



62-2377 - 36" W (shown)  
Vintage Brass



# HAZEL LED

3-CCT SELECTABLE - 2700K | 3000K | 3500K

Transform your most treasured artwork and cherished photographs into captivating focal points with the Hazel Collection picture lights, a masterpiece in design where every light tells a story.

### FINISH OPTIONS



Black Acrylic Lens



Brushed Nickel Acrylic Lens



Vintage Brass Acrylic Lens



62-2320 - 12" W (shown)  
Black

ITEM#	DESCRIPTION	FINISH	LIGHT SOURCE	WATTS	WIDTH	HEIGHT	EXT.	CCT	LUMENS	CRI	CERT. TYPE
62-2320	12" Picture Lt.	Black Acrylic Lens	LED	12W	12.2"	4.7"	8.6"	2700K/3000K/3500K	960	90	Dry
62-2321	12" Picture Lt.	Brushed Nickel Acrylic Lens	LED	12W	12.2"	4.7"	8.6"	2700K/3000K/3500K	960	90	Dry
62-2322	12" Picture Lt.	Vintage Brass Acrylic Lens	LED	12W	12.2"	4.7"	8.6"	2700K/3000K/3500K	960	90	Dry
62-2325	24" Picture Lt.	Black Acrylic Lens	LED	20W	24"	4.7"	8.6"	2700K/3000K/3500K	1600	90	Dry
62-2326	24" Picture Lt.	Brushed Nickel Acrylic Lens	LED	20W	24"	4.7"	8.6"	2700K/3000K/3500K	1600	90	Dry
62-2327	24" Picture Lt.	Vintage Brass Acrylic Lens	LED	20W	24"	4.7"	8.6"	2700K/3000K/3500K	1600	90	Dry
62-2330	36" Picture Lt.	Black Acrylic Lens	LED	35W	35.8"	4.7"	8.6"	2700K/3000K/3500K	2800	90	Dry
62-2331	36" Picture Lt.	Brushed Nickel Acrylic Lens	LED	35W	35.8"	4.7"	8.6"	2700K/3000K/3500K	2800	90	Dry
62-2332	36" Picture Lt.	Vintage Brass Acrylic Lens	LED	35W	35.8"	4.7"	8.6"	2700K/3000K/3500K	2800	90	Dry



62-2326 - 24" W (shown)  
Brushed Nickel



62-2332 - 36" W (shown)  
Vintage Brass



# MILA LED

3-CCT SELECTABLE - 2700K | 3000K | 3500K

Unveil the beauty of your most treasured pieces with the Mila Collection, an LED modern picture light designed to captivate. With clean lines and a sleek silhouette, the Mila Collection is a celebration of contemporary elegance, offering a minimalist touch that enhances rather than overpowers your space.

## FINISH OPTIONS



Black  
Acrylic Lens



Brushed Nickel  
Acrylic Lens



Vintage Brass  
Acrylic Lens



62-2335 - 12" W (shown)  
Black

ITEM#	DESCRIPTION	FINISH	LIGHT SOURCE	WATTS	WIDTH	HEIGHT	EXT.	CCT	LUMENS	CRI	CERT. TYPE
62-2335	12" Picture Lt.	Black Acrylic Lens	LED	12W	12.2"	4.7"	7.1"	2700K/3000K/3500K	960	90	Damp
62-2336	12" Picture Lt.	Brushed Nickel Acrylic Lens	LED	12W	12.2"	4.7"	7.1"	2700K/3000K/3500K	960	90	Damp
62-2337	12" Picture Lt.	Vintage Brass Acrylic Lens	LED	12W	12.2"	4.7"	7.1"	2700K/3000K/3500K	960	90	Damp
62-2340	24" Picture Lt.	Black Acrylic Lens	LED	20W	24"	4.7"	7.1"	2700K/3000K/3500K	1600	90	Damp
62-2341	24" Picture Lt.	Brushed Nickel Acrylic Lens	LED	20W	24"	4.7"	7.1"	2700K/3000K/3500K	1600	90	Damp
62-2342	24" Picture Lt.	Vintage Brass Acrylic Lens	LED	20W	24"	4.7"	7.1"	2700K/3000K/3500K	1600	90	Damp
62-2345	36" Picture Lt.	Black Acrylic Lens	LED	35W	35.8"	4.7"	7.1"	2700K/3000K/3500K	2800	90	Damp
62-2346	36" Picture Lt.	Brushed Nickel Acrylic Lens	LED	35W	35.8"	4.7"	7.1"	2700K/3000K/3500K	2800	90	Damp
62-2347	36" Picture Lt.	Vintage Brass Acrylic Lens	LED	35W	35.8"	4.7"	7.1"	2700K/3000K/3500K	2800	90	Damp



62-2341 - 24" W (shown)  
Brushed Nickel



62-2347 - 36" W (shown)  
Vintage Brass

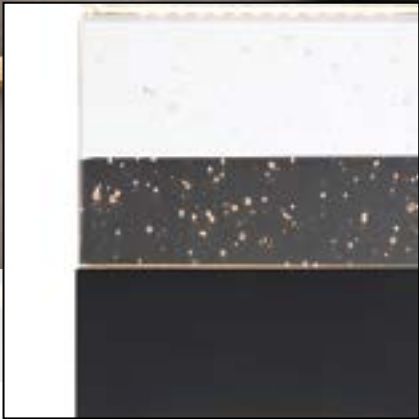

# ELLUSION LED

Modern, sleek, and refined, Ellusion is at the forefront of stylish lighting. Exuding elegance from every angle, charm your guests with this romantic, yet forward statement in lighting.

ITEM	DESCRIPTION	FINISH	LIGHT SOURCE	WATTS	WIDTH	HEIGHT	EXT.	CCT	LUMENS	CRI	CERT. TYPE
62-1501	Sm. Sconce	Polished Nickel Seeded Glass	LED	15W	4.75"	6.38"	2.5"	3000K	675	90	Damp
62-1502	Med. Sconce	Polished Nickel Seeded Glass	LED	15W	7.25"	7"	2.5"	3000K	675	90	Damp
62-1503	Lg. Sconce	Polished Nickel Seeded Glass	LED	13W	4.75"	14.38"	2.38"	3000K	700	90	Damp
62-1511	Sm. Sconce	Matte Black Seeded Glass	LED	15W	4.75"	6.38"	2.5"	3000K	675	90	Damp
62-1512	Med. Sconce	Matte Black Seeded Glass	LED	15W	7.25"	7"	2.5"	3000K	675	90	Damp
62-1513	Lg. Sconce	Matte Black Seeded Glass	LED	13W	4.75"	14.38"	2.38"	3000K	700	90	Damp



ADA Compliant



62-1501 - 5" W (shown)  
Polished Nickel



62-1513 - 15" Ht (shown)  
Matte Black

## FINISH



Polished Nickel Seeded Glass



Matte Black Seeded Glass



# HAWK LED

The Hawk wall sconce is a modern-contemporary design that features a pivoting head, with added functionality. Showcase a home bar or highlight an alcove featuring a statue or piece of artwork. Bring terrific lighting style to your home.

ITEM	DESCRIPTION	FINISH	LIGHT SOURCE	WATTS	WIDTH	HEIGHT	EXT.	CCT	LUMENS	CRI	CERT. TYPE
62-992	Sconce	White	LED	15W	6.5"	5"	7.63"	3000K	1190	90	Damp
62-993	Sconce	Black	LED	15W	6.5"	5"	7.63"	3000K	1190	90	Damp
62-994	Sconce	Brushed Nickel	LED	15W	6.5"	5"	7.63"	3000K	1190	90	Damp



62-992 - 7" W  
White



62-993 - 7" W  
Black



62-994 - 7" W  
Brushed Nickel

## FINISH OPTIONS



White



Black



Brushed Nickel



# TUCKER LED

Simple, functional, no-nonsense style at it's finest, Tucker fits the bill. A sophisticated wall sconce with a minimal design perfect for hard-to-fit areas where lighting is desired.

ITEM	DESCRIPTION	FINISH	LIGHT SOURCE	WATTS	WIDTH	HEIGHT	EXT.	CCT	LUMENS	CRI	CERT. TYPE
62-185	Sconce / Vanity	Polished Nickel Etched Opal Glass	LED	10W	6"	11.5"	3.75"	3000K	800	82	Damp
62-186	Sconce / Vanity	Aged Bronze Etched Opal Glass	LED	10W	6"	11.5"	3.75"	3000K	800	82	Damp



CUL listed for horizontal or vertical installation  
ADA compliant



62-185 - 6" W  
Polished Nickel



62-186 - 6" W  
Aged Bronze

## FINISH OPTIONS



Polished Nickel  
Etched Opal Glass



Aged Bronze  
Etched Opal Glass



# TRAX LED

A modern, eclectic spin on lighting design, the Trax collection ushers in a chic era of home illumination. It's unique style pairs well in a contemporary setting, yet it is versatile enough for everyday home decors.

ITEM	DESCRIPTION	FINISH	LIGHT SOURCE	WATTS	WIDTH	HEIGHT	EXT.	CCT	LUMENS	CRI	CERT. TYPE
62-102	Sconce	Brushed Nickel Frosted Glass	LED	10W	7"	20"	3.5"	3000K	800	82	Damp
62-122	Sconce	Hazel Bronze Frosted Glass	LED	10W	7"	20"	3.5"	3000K	800	82	Damp



CUL listed for horizontal or vertical installation



62-122 - 7" W  
Hazel Bronze



62-102 - 7" W  
Brushed Nickel

## FINISH OPTIONS



Brushed Nickel  
Frosted Glass



Hazel Bronze  
Frosted Glass



# DONZI

The Donzi blends a fresh modern design with a bit of antique flair. Light up your home with this elegant, simplistic design that creates maximum impact with it's unique style.

ITEM	DESCRIPTION	FINISH	NO. OF LIGHTS	LAMP TYPE	BASE	MAX WATTS	WIDTH	HEIGHT	EXT.	CERT TYPE
60-6381	1 Lt. Sconce/Vanity	Iron Black Clear Seeded Glass	1	*T9	Med.	60W	4.5"	12.88"	4.38"	Damp
60-6382	2 Lt. Vanity	Iron Black Clear Seeded Glass	2	*T9	Med.	60W	27.5"	4.5"	4.38"	Damp



60-6382 - 28" W



60-6381 - 5" W

## FINISH



Iron Black  
Clear Seeded Glass



\*T9 Vintage  
Lamps Included



# PEAK LED

3-CCT SELECTABLE - 3000K | 4000K | 5000K

Peak, the epitome of modern lighting innovation. Crafted in a sleek matte black, white, or gray finish, each fixture features adjustable barn door louvers for tailored illumination. With a remarkable color rendering index (CRI) of 90, Peak offers a choice of three CCT options: 3000K, 4000K, or 5000K, ensuring both efficiency and a cozy atmosphere. Peak's compact design seamlessly integrates into any space, offering versatility without compromise. Elevate your surroundings with Peak's unparalleled blend of style and functionality.

ITEM	DESCRIPTION	FINISH	LIGHT SOURCE	WATTS	WIDTH	HEIGHT	EXT.	CCT	LUMENS	CRI	CERT. TYPE
62-245	Sconce	Matte Black	LED	10W	5.75"	9"	3.50"	3000/4000/5000K	436	90	Damp
62-246	Sconce	Matte White	LED	10W	5.75"	9"	3.50"	3000/4000/5000K	436	90	Damp
62-247	Sconce	Matte Gray	LED	10W	5.75"	9"	3.50"	3000/4000/5000K	436	90	Damp



Adjustable barn door louvered Panels  
CUL listed for horizontal or vertical installation  
ADA compliant



62-245 - 6" W  
Matte Black



62-246 - 6" W  
Matte White



62-247 - 6" W  
Matte Gray

## FINISH OPTIONS



Matte Black



Matte White



Matte Gray



# TRIBECA

The Tribeca sconces feature slender and squared double arms that support a hard cornered rectangular white linen shade, sculpted in design and emphasized by the rectangular back plate. Precision and grace in the new modern classic luminaire.

## FINISH OPTIONS



Burnished Brass w/  
White Linen Shade



Polished Nickel w/  
White Linen Shade



Aged Bronze w/  
White Linen Shade

ITEM#	DESCRIPTION	FINISH	NO. OF LIGHTS	LAMP TYPE	BASE	WATTS	WIDTH	HEIGHT	EXT.	CERT. TYPE
60-6717	2 Lt. Sconce	Burnished Brass w/ White Linen Shade	2	B11	Cand.	60W	14"	11.63"	6"	Damp
60-6718	2 Lt. Sconce	Polished Nickel w/ White Linen Shade	2	B11	Cand.	60W	14"	11.63"	6"	Damp
60-6719	2 Lt. Sconce	Aged Bronze w/ White Linen Shade	2	B11	Cand.	60W	14"	11.63"	6"	Damp



60-6717 - 14" W  
Burnished Brass



60-6718 - 14" W  
Polished Nickel



60-6719 - 14" W  
Aged Bronze



# OLMSTEAD

Enchanting with its refined elegance and timeless appeal, the Olmstead wall sconces feature delicate details within it's sleek yet charming design. Bring a romantic, polished glow to any room, infusing your home with a classic allure and modern flair.

ITEM	DESCRIPTION	FINISH	NO. OF LIGHTS	LAMP TYPE	BASE	MAX WATTS	WIDTH	HEIGHT	EXT.	CERT. TYPE
60-6687	1Lt. Sconce	Burnished Brass White Linen Shade	1	B11	Cand.	60W	5.5"	19"	6.75"	Damp
60-6688	1Lt. Sconce	Polished Nickel White Linen Shade	1	B11	Cand.	60W	5.5"	19"	6.75"	Damp
60-6689	1Lt. Sconce	Aged Bronze White Linen Shade	1	B11	Cand.	60W	5.5"	19"	6.75"	Damp



60-6687 - 6" W  
Burnished Brass



60-6688 - 6" W  
Polished Nickel



60-6689 - 6" W  
Aged Bronze

## FINISH OPTIONS



Burnished Brass  
White Linen Shade



Polished Nickel  
White Linen Shade



Aged Bronze  
White Linen Shade



# THOMPSON

The Thompson wall sconces are elegant pieces re-imagined with classic charm with a modern twist. Their captivating presence and refined design bring a touch of timeless sophistication to any space, making it a stunning addition to your home.

ITEM	DESCRIPTION	FINISH	NO. OF LIGHTS	LAMP TYPE	BASE	MAX WATTS	WIDTH	HEIGHT	EXT.	CERT. TYPE
60-6681	1 Lt. Sconce	Burnished Brass White Linen Shade	1	B11	Cand.	60W	5"	18.88"	6.75"	Damp
60-6682	1 Lt. Sconce	Polished Nickel White Linen Shade	1	B11	Cand.	60W	5"	18.88"	6.75"	Damp



60-6681 - 5" W  
Burnished Brass



60-6682 - 5" W  
Polished Nickel

## FINISH OPTIONS



Burnished Brass  
White Linen Shade



Polished Nickel  
White Linen Shade

# VESEY

A striking embodiment of contemporary elegance, the Vesey wall sconces showcases a sleek design that brings a touch of understated luxury to any room. With a visual balance and sophistication, the harmonious silhouette captures attention without overwhelming the space, making them equally suited for modern and classic interiors.



ITEM	DESCRIPTION	FINISH	NO. OF LIGHTS	LAMP TYPE	BASE	MAX WATTS	WIDTH	HEIGHT	EXT.	CERT. TYPE
60-6691	1Lt. Sconce	Brushed Nickel White Linen Shade	1	B11	Cand.	60W	4.5"	18"	5.13"	Damp
60-6692	1Lt. Sconce	Burnished Brass White Linen Shade	1	B11	Cand.	60W	4.5"	18"	5.13"	Damp
60-6693	1Lt. Sconce	Polished Nickel White Linen Shade	1	B11	Cand.	60W	4.5"	18"	5.13"	Damp



60-6691- 5" W  
Brushed Nickel



60-6692- 5" W  
Burnished Brass



60-6693- 5" W  
Polished Nickel

## FINISH OPTIONS



Brushed Nickel  
White Linen Shade



Burnished Brass  
White Linen Shade



Polished Nickel  
White Linen Shade

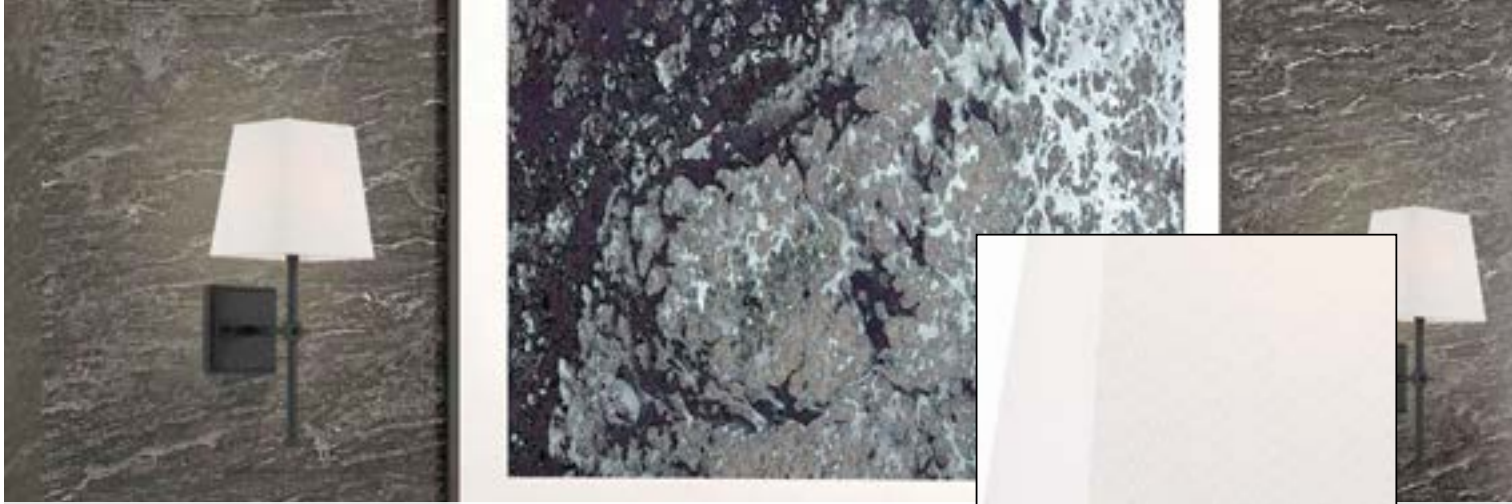

# HIGHLINE

The Highline wall sconces capture timeless romance with an elegant design that gently embrace it's refined structure. With its sleek and modern allure, these pieces infuse any space with sophistication, charm and enchanting style.

ITEM	DESCRIPTION	FINISH	NO. OF LIGHTS	LAMP TYPE	BASE	MAX WATTS	WIDTH	HEIGHT	EXT.	CERT. TYPE
60-6707	1 Lt. Sconce	Burnished Brass White Linen Shade	1	B11	Cand.	60W	6"	16"	7.25"	Damp
60-6708	1 Lt. Sconce	Polished Nickel White Linen Shade	1	B11	Cand.	60W	6"	16"	7.25"	Damp
60-6709	1 Lt. Sconce	Aged Bronze White Linen Shade	1	B11	Cand.	60W	6"	16"	7.25"	Damp



60-6707 - 6" W  
Burnished Brass



60-6708 - 6" W  
Polished Nickel



60-6709 - 6" W  
Aged Bronze

## FINISH OPTIONS



Burnished Brass  
White Linen Shade



Polished Nickel  
White Linen Shade



Aged Bronze  
White Linen Shade



# SLOAN

The Sloan Collection radiates sophistication for today's home, casting a mesmerizing glow that transforms any room into a haven of stylish elegance. Elevate your home with this modern, alluring and captivating design.

## FINISH OPTIONS



Matte Black  
Polished Nickel



Polished Nickel  
Matte White



Matte Black  
Matte White



Matte Black  
Burnished Brass

ITEM	DESCRIPTION	FINISH	NO. OF LIGHTS	LAMP TYPE	BASE	MAX WATTS	WIDTH	HEIGHT	EXT.	CERT. TYPE
60-6771	1 Lt. Sconce / Vanity	Matte Black Polished Nickel	1	A19	Med.	100W	5.88"	10.38"	6.63"	Damp
60-6772	2 Lt. Vanity	Matte Black Polished Nickel	2	A19	Med.	100W	13.75"	10.38"	6.63"	Damp
60-6773	3 Lt. Vanity	Matte Black Polished Nickel	3	A19	Med.	100W	21.63"	10.38"	6.63"	Damp
60-6781	1 Lt. Sconce / Vanity	Polished Nickel Matte White	1	A19	Med.	100W	5.88"	10.38"	6.63"	Damp
60-6782	2 Lt. Vanity	Polished Nickel Matte White	2	A19	Med.	100W	13.75"	10.38"	6.63"	Damp
60-6783	3 Lt. Vanity	Polished Nickel Matte White	3	A19	Med.	100W	21.63"	10.38"	6.63"	Damp
60-6784	1 Lt. Sconce / Vanity	Matte Black Matte White	1	A19	Med.	100W	5.88"	10.38"	6.63"	Damp
60-6785	2 Lt. Vanity	Matte Black Matte White	2	A19	Med.	100W	13.75"	10.38"	6.63"	Damp
60-6786	3 Lt. Vanity	Matte Black Matte White	3	A19	Med.	100W	21.63"	10.38"	6.63"	Damp
60-6791	1 Lt. Sconce / Vanity	Matte Black Burnished Brass	1	A19	Med.	100W	5.88"	10.38"	6.63"	Damp
60-6792	2 Lt. Vanity	Matte Black Burnished Brass	2	A19	Med.	100W	13.75"	10.38"	6.63"	Damp
60-6793	3 Lt. Vanity	Matte Black Burnished Brass	3	A19	Med.	100W	21.63"	10.38"	6.63"	Damp

CUL listed for optional up or down installation



60-6771 - 6" W (shown)  
Polished Nickel



60-6782 - 14" W (shown)  
Matte White



60-6793 - 22" W (shown)  
Burnished Brass



# TRILBY

The Trilby wall light features an adjustable swing arm and a versatile finish and is perfect for a reading nook or office area. Trilby suits a variety of home decor.

## FINISH OPTIONS



Matte White  
Burnished Brass

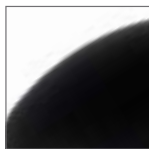

Matte Black  
Burnished Brass

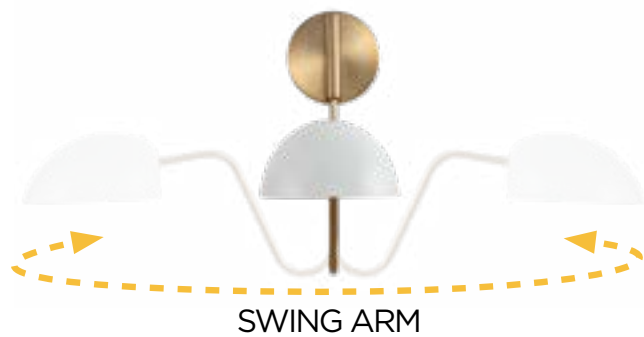

ITEM	DESCRIPTION	FINISH	NO. OF LIGHTS	LAMP TYPE	BASE	MAX WATTS	WIDTH	HEIGHT	EXT.	CERT. TYPE
60-7391	1 Lt. Swing Arm Sconce	Burnished Brass / Matte Black	1	A19	Med.	60W	7.38"	16"	20.38"	Damp
60-7392	1 Lt. Swing Arm Sconce	Burnished Brass / Matte White	1	A19	Med.	60W	7.38"	16"	20.38"	Damp
60-7393	2 Lt. Swing Arm Sconce	Burnished Brass / Matte Black	2	A19	Med.	60W	37.38"	25.88"	20.38"	Damp
60-7394	2 Lt. Swing Arm Sconce	Burnished Brass / Matte White	2	A19	Med.	60W	37.38"	25.88"	20.38"	Damp



60-7394 - 38" W (shown)  
Matte White



60-7391 - 7" W (shown)  
Matte Black



# BAYARD

Single-light Swing Arm Lamps with multi-position arms, a decorative switch and optional wire covers, make these modern industrial lamps easy to add to a number of different environments. Mount on the ceiling with direct wire option for kitchen lighting, book cases and gallery art, or wall mount for bedside lighting, reading chairs and more. With the ability to be hardwired or plugged in an outlet, these lamps offer versatility and beauty for many areas of your home or office.

ITEM	DESCRIPTION	FINISH	NO. OF LIGHTS	LIGHT SOURCE	BASE	WATTS	WIDTH	HEIGHT	EXT.	CERT. TYPE
60-7367	Swing Arm Lamp	Burnished Brass w/ Switch	1	A19	Med.	60W	8"	13.38"	25.25"	Dry
60-7368	Swing Arm Lamp	Polished Nickel w/ Switch	1	A19	Med.	60W	8"	13.38"	25.25"	Dry
60-7369	Swing Arm Lamp	Matte Black w/ Switch	1	A19	Med.	60W	8"	13.38"	25.25"	Dry

2 Optional Wire Covers Included, totaling 18"  
Convertible from Plug-in to Direct Wire



60-7367 - 8" W  
Burnished Brass



SWITCH

60-7368 - 8" W  
Polished Nickel



60-7369 - 8" W  
Matte Black

## FINISH OPTIONS



Burnished Brass w/  
Switch



Polished Nickel w/  
Switch



Matte Black w/  
Switch



# DELANCEY

Single-light Swing Arm Lamps with multi-position arms, a decorative switch and optional wire covers, make these modern industrial lamps easy to add to a number of different environments. Mount on the ceiling with direct wire option for kitchen lighting, book cases and gallery art, or wall mount for bedside lighting, reading chairs and more. With the ability to be hardwired or plugged in an outlet, these lamps offer versatility and beauty for many areas of your home or office.

ITEM	DESCRIPTION	FINISH	NO. OF LIGHTS	LIGHT SOURCE	BASE	WATTS	WIDTH	HEIGHT	EXT.	CERT. TYPE
60-7361	Swing Arm Lamp	Burnished Brass w/ Switch	1	A19	Med.	60W	8"	10.38"	27.38"	Dry
60-7362	Swing Arm Lamp	Polished Nickel w/ Switch	1	A19	Med.	60W	8"	10.38"	27.38"	Dry
60-7363	Swing Arm Lamp	Matte Black w/ Switch	1	A19	Med.	60W	8"	10.38"	27.38"	Dry

2 Optional Wire Covers Included, totaling 18"  
Convertible from Plug-in to Direct Wire



60-7361 - 8" W  
Burnished Brass



60-7362 - 8" W  
Polished Nickel



60-7363 - 8" W  
Matte Black

## FINISH OPTIONS



Burnished Brass w/  
Switch



Polished Nickel w/  
Switch



Matte Black w/  
Switch

# KENDALL LED

3-CCT SELECTABLE - 3000K | 4000K | 5000K

For those who appreciate refined subtlety, the Kendall flush mounts imbue your living space with light and transitional elegance. It's a declaration of modern sophistication that captivates the senses, making a bold statement in any room.



ITEM	DESCRIPTION	FINISH	LIGHT SOURCE	WATTS	WIDTH	HEIGHT	CCT	LUMENS	CRI	CERT TYPE
62-2101	14" Flush Mount	Matte Black w/ Alabaster Glass	LED	25W	14.25"	2.5"	3000/4000/5000K	2100-2200	90	Damp
62-2111	14" Flush Mount	Brushed Nickel w/ Alabaster Glass	LED	25W	14.25"	2.5"	3000/4000/5000K	2100-2200	90	Damp
62-2121	14" Flush Mount	Burnished Brass w/ Alabaster Glass	LED	25W	14.25"	2.5"	3000/4000/5000K	2100-2200	90	Damp



62-2121 - 14" W (shown)  
Burnished Brass

## FINISH



Matte Black w/  
Alabaster Glass



Brushed Nickel w/  
Alabaster Glass



Burnished Brass w/  
Alabaster Glass



# PI LED

3-CCT SELECTABLE - 3000K | 4000K | 5000K

The Pi flush mounts offer a clean aesthetic, superior light quality and energy savings that can go anywhere. Illuminate kitchens, bathrooms, hallways, and office spaces with this sleek fixture, that delivers a warm glow of light.

ITEM	DESCRIPTION	FINISH	LIGHT SOURCE	WATTS	WIDTH	HEIGHT	CCT	MAX LUMENS	CRI	CERT. TYPE
62-558	9" Flush Mount	Brushed Nickel Etched Glass	LED	18W	9"	3.13"	3000/4000/5000K	1500-1700	90	Damp
62-559	11" Flush Mount	Brushed Nickel Etched Glass	LED	25W	11"	3.13"	3000/4000/5000K	2100-2200	90	Damp
62-560	14" Flush Mount	Brushed Nickel Etched Glass	LED	25W	14"	3.13"	3000/4000/5000K	2100-2200	90	Damp
62-568	9" Flush Mount	Matte Black Etched Glass	LED	18W	9"	3.13"	3000/4000/5000K	1500-1700	90	Damp
62-569	11" Flush Mount	Matte Black Etched Glass	LED	25W	11"	3.13"	3000/4000/5000K	2100-2200	90	Damp
62-570	14" Flush Mount	Matte Black Etched Glass	LED	25W	14"	3.13"	3000/4000/5000K	2100-2200	90	Damp



62-558 - 9" W (shown)  
Brushed Nickel



62-569 - 11" W (shown)  
Matte Black

## FINISH OPTIONS



Brushed Nickel  
Etched Glass



Matte Black  
Etched Glass

# BUTTON LED

3-CCT SELECTABLE - 3000K | 4000K | 5000K

Need an unassuming fixture that suits any décor, look no further than the Button flush mount series. LED efficiency and a simple style that is perfect for any room in the home.



ITEM	DESCRIPTION	FINISH	LIGHT SOURCE	WATTS	WIDTH	HEIGHT	CCT	LUMENS	CRI	CERT. TYPE
62-1842	11" Flush Mount	Brushed Nickel	LED	18W	11"	3.88"	3000/4000/5000K	1500-1700	90	Damp
62-1843	13" Flush Mount	Brushed Nickel	LED	18W	13.38"	4"	3000/4000/5000K	1500-1700	90	Damp
62-1844	17" Flush Mount	Brushed Nickel	LED	25W	17"	5"	3000/4000/5000K	2100-2200	90	Damp
62-1942	11" Flush Mount	Matte Black	LED	18W	11"	3.88"	3000/4000/5000K	1500-1700	90	Damp
62-1943	13" Flush Mount	Matte Black	LED	18W	13.38"	4"	3000/4000/5000K	1500-1700	90	Damp
62-1944	17" Flush Mount	Matte Black	LED	25W	17"	5"	3000/4000/5000K	2100-2200	90	Damp



62-1842 - 11" W (shown)  
Brushed Nickel



62-1943 - 13" W (shown)  
Matte Black



62-1844 - 17" W (shown)  
Brushed Nickel

## FINISH OPTIONS



Brushed Nickel  
Frosted Glass



Matte Black  
Frosted Glass



# DALE LED

Dale flush mounts bring a chic, modern touch to any room, adding warm, inviting light that sets the mood beautifully. Perfect for brightening living rooms, dining areas, hallways, and entry ways, they complement any decor style with ease.

ITEM	DESCRIPTION	FINISH	LIGHT SOURCE	WATTS	WIDTH	HEIGHT	CCT	LUMENS	CRI	CERT. TYPE
62-609	Flush Mount	Brushed Nickel Opal Frosted Glass	LED	18W	13"	2"	3000K	1400	90	Damp
62-709	Flush Mount	Mahogany Bronze Opal Frosted Glass	LED	18W	13"	2"	3000K	1400	90	Damp



Lumens measured at LED source



62-609 - 13" W  
Brushed Nickel



62-709 - 13" W  
Mahogany Bronze

## FINISH OPTIONS



Brushed Nickel  
Opal Frosted Glass



Mahogany Bronze  
Opal Frosted Glass



# HEATHER LED

Our Heather LED flush mounts bring a warm, stylish vibe to any space. It's perfect for creating a cozy glow in living rooms, dining areas, hallways, and entry ways. This chic light offers a beautiful ambiance that lasts, illuminating your home with a gentle, inviting warmth.

## FINISH OPTIONS



Polished Nickel  
White Linen  
Shade



Brushed Nickel  
White Linen  
Shade



Aged Bronze  
White Linen  
Shade

ITEM	DESCRIPTION	FINISH	LIGHT SOURCE	WATTS	WIDTH	HEIGHT	CCT	LUMENS	CRI	CERT. TYPE
62-524	Flush Mount	Brushed Nickel White Linen Shade	LED	18W	13"	3.88"	3000K	1500	90	Damp
62-525	Flush Mount	Aged Bronze White Linen Shade	LED	18W	13"	3.88"	3000K	1500	90	Damp
62-526	Flush Mount	Polished Nickel White Linen Shade	LED	18W	13"	3.88"	3000K	1500	90	Damp



62-524 - 13" W  
Brushed Nickel



62-525 - 13" W  
Aged Bronze



62-526 - 13" W  
Polished Nickel



# SELENE LED

5-CCT SELECTABLE - 2700 | 3000 | 3500 | 4000 | 5000K

SATCO|NUVO's beautiful Selene LED Flush Mount Fixtures brighten your surroundings and elevate the overall atmosphere of your space. These fixtures come in 13-inch and 17-inch sizes and are available in black and white finishes. Experience the clarity of 90 CRI lighting from these timeless fixtures, accompanied by the subtle and soft glow of the built-in halo accent feature. Offering selectable CCT options, dimming capabilities, and a damp location rating, these fixtures effortlessly combine style and functionality in a sleek design.

ITEM	DESCRIPTION	FINISH	LIGHT SOURCE	WATTS	WIDTH	HEIGHT	CCT	LUMENS	CRI	CERT. TYPE
62-1695	13" Flush Mount	White	LED	22W	13.23"	2.90"	2700/3000/3500/4000/5000K	1400-1450	90	Damp
62-1696	13" Flush Mount	Black	LED	22W	13.23"	2.90"	2700/3000/3500/4000/5000K	1200-1250	90	Damp
62-1697	17" Flush Mount	White	LED	27W	16.61"	3.16"	2700/3000/3500/4000/5000K	2000-2050	90	Damp
62-1698	17" Flush Mount	Black	LED	27W	16.61"	3.16"	2700/3000/3500/4000/5000K	2000-2050	90	Damp



62-1695 - 13" W (shown)  
White



62-1698 - 17" W (shown)  
Black

## FINISH OPTIONS



White



Black



Built in Halo-Lit  
Accent

# FLUSH FIXTURE LED

5-CCT SELECTABLE - 2700 | 3000 | 3500 | 4000 | 5000K

Illuminate your space with SATCO|NUVO's Flush Mount Fixture featuring a built-in nightlight. Enjoy the convenience of clear 90 CRI lighting from a classic flush mount fixture, but with the added benefit of an integrated night light all operated from a single switch. CCT selectable, dimmable, and damp location rated, this fixture is the perfect combination of style and functionality in one sleek design.



ITEM	DESCRIPTION	FINISH	LIGHT SOURCE	WATTS	WIDTH	HEIGHT	CCT	LUMENS	CRI	CERT. TYPE
62-1690	11" Surface Mount	Brushed Nickel	LED	24W	11.42"	2.28"	2700/3000/3500/4000/5000K	1500-1700	90	Damp
62-1691	11" Surface Mount	Matte Black	LED	24W	11.42"	2.28"	2700/3000/3500/4000/5000K	1500-1700	90	Damp
62-1692	15" Surface Mount	Brushed Nickel	LED	26W	14.37"	2.60"	2700/3000/3500/4000/5000K	1700-2000	90	Damp
62-1693	15" Surface Mount	Matte Black	LED	26W	14.37"	2.60"	2700/3000/3500/4000/5000K	1700-2000	90	Damp



62-1690 - 11" W (shown)  
Brushed Nickel



62-1693 - 14" W (shown)  
Matte Black

## FINISH OPTIONS



Brushed Nickel



Matte Black



Built in Night Light  
Accent



# ROWEN

The Rowen Collection is a versatile series of flush mounts that exude elegance and sophistication. Rowen suits a variety of settings, including hallways, bedrooms, living rooms, and dining areas. Overall, Rowen is the perfect combination of form and function.

ITEM	DESCRIPTION	FINISH	NO. OF LIGHTS	LAMP TYPE	BASE	MAX WATTS	WIDTH	HEIGHT	CERT. TYPE
60-7750	3 Lt. Flush Mount	Natural Brass Etched White Glass	3	A19	Med.	60W	14.63"	4.5"	Damp
60-7751	4 Lt. Flush Mount	Natural Brass Etched White Glass	4	A19	Med.	60W	18.5"	5"	Damp
60-7752	4 Lt. Semi-Flush	Natural Brass Etched White Glass	4	A19	Med.	60W	18.5"	11.13"	Damp
60-7753	3 Lt. Semi-Flush	Natural Brass Etched White Glass	3	A19	Med.	60W	14.63"	9.63"	Damp
60-7760	3 Lt. Flush Mount	Brushed Nickel Etched White Glass	3	A19	Med.	60W	14.63"	4.5"	Damp
60-7761	4 Lt. Flush Mount	Brushed Nickel Etched White Glass	4	A19	Med.	60W	18.5"	5"	Damp
60-7762	4 Lt. Semi-Flush	Brushed Nickel Etched White Glass	4	A19	Med.	60W	18.5"	11.13"	Damp
60-7763	3 Lt. Semi-Flush	Brushed Nickel Etched White Glass	3	A19	Med.	60W	14.63"	9.63"	Damp



60-7761 - 19" W (shown)  
Brushed Nickel



60-7752 - 19" W (shown)  
Natural Brass

## FINISH OPTIONS



Natural Brass  
Etched White Glass



Brushed Nickel  
Etched White Glass



# NEVAL

The Neval flush mount casts a warm, inviting glow that transforms your home lighting, creating an ambiance of elegance and comfort. Neval adds a timeless beauty to any space, making every evening feel a little more enchanting.

ITEM	DESCRIPTION	FINISH	NO. OF LIGHTS	LAMP TYPE	BASE	MAX WATTS	WIDTH	HEIGHT	CERT. TYPE
60-5486	2 Lt. Flush Mount	Brushed Nickel Satin White Glass	2	A19	Med.	60W	13"	5.25"	Damp
60-5586	2 Lt. Flush Mount	Sudbury Bronze Satin White Glass	2	A19	Med.	60W	13"	5.25"	Damp



60-5486 - 13" W  
Brushed Nickel



60-5586 - 13" W  
Sudbury Bronze

## FINISH OPTIONS



Brushed Nickel  
Satin White Glass



Sudbury Bronze  
Satin White Glass



# CUTTY

The Cutty semi-flush mounts invite a soft, romantic glow to any space, blending timeless elegance with subtle charm. Perfect for any decor, this fixture creates an atmosphere that's both inviting and gracefully refined, bringing a touch of warmth and sophistication to your home.

ITEM	DESCRIPTION	FINISH	NO. OF LIGHTS	LAMP TYPE	BASE	MAX WATTS	WIDTH	HEIGHT	CERT. TYPE
60-6996	3 Lt. Semi-Flush	Polished Nickel & White Fabric Shade Frosted Glass	3	A19	Med.	60W	15.5"	12"	Dry
60-6997	3 Lt. Semi-Flush	Burnished Brass & White Fabric Shade Frosted Glass	3	A19	Med.	60W	15.5"	12"	Dry
60-6998	3 Lt. Semi-Flush	Matte Black & White Fabric Shade Frosted Glass	3	A19	Med.	60W	15.5"	12"	Dry

Additional chain: Polished Nickel (3') 25-4141, Burnished Brass (3') 25-467, Matte Black (3') 25-475

Pendant conversion kit for semi flush: (Polished Nickel): 25-4143, (Burnished Brass): 25-3036, (Matte Black): 25-3034  
12' of wire supplied



60-6998 - 16" W  
Matte Black

## FINISH OPTIONS



Polished Nickel & White Fabric Shade Frosted Glass



Burnished Brass & White Fabric Shade Frosted Glass



Matte Black & White Fabric Shade Frosted Glass



60-6997- 16" W  
Burnished Brass



60-6996 - 16" W  
Polished Nickel



# CHANTECLEER

The Chantecleer flush mounts are simple, yet stylish, and ideal for smaller spaces. Providing illumination to a stairwell, entry way, or powder room, Chantecleer is perfect accessory to complete your lighting needs.

ITEM	DESCRIPTION	FINISH	NO. OF LIGHTS	LAMP TYPE	BASE	WATTS	WIDTH	HEIGHT	CERT. TYPE
60-6778	1Lt. Semi-Flush	Polished Nickel Clear Glass	1	A19	Med.	100W	9.875"	11.375"	Damp
60-6779	1Lt. Semi-Flush	Matte Black Clear Glass	1	A19	Med.	100W	9.875"	11.375"	Damp



60-6778 - 10" W  
Polished Nickel



60-6779 - 10" W  
Matte Black

## FINISH OPTIONS



Polished Nickel  
Clear Glass



Matte Black  
Clear Glass



# KEW

The Kew semi-flush mounts bring vintage charm with a modern flair to any room. Inspired by mid-century modern design, these fixture capture your attention with sleek lines and timeless elegance, adding a touch of sophistication and character to your decor.

ITEM	DESCRIPTION	FINISH	NO. OF LIGHTS	LAMP TYPE	BASE	WATTS	WIDTH	HEIGHT	CERT. TYPE
60-6797	1 Lt. Semi-Flush	Burnished Brass Clear Glass	1	A19	Med.	60W	10.38"	10"	Damp
60-6798	1 Lt. Semi-Flush	Polished Nickel Clear Glass	1	A19	Med.	60W	10.38"	10"	Damp
60-6799	1 Lt. Semi-Flush	Aged Bronze Clear Glass	1	A19	Med.	60W	10.38"	10"	Damp



60-6797 - 10" W  
Burnished Brass



60-6798 - 10" W  
Polished Nickel



60-6799 - 10" W  
Aged Bronze

## FINISH OPTIONS



Burnished Brass  
Clear Glass



Polished Nickel  
Clear Glass



Aged Bronze  
Clear Glass



# NUVO basics

## TRANSFORM LIVING SPACES

Our exquisite range of residential decorative lighting products. These fixtures go beyond mere functionality, elevating the ambiance of any home to new levels of sophistication and charm. Our diverse selection includes elegant chandeliers, stylish pendant lights, unique wall sconces and modern flush mount fixtures.

Each piece is thoughtfully designed to cater to unique preferences and needs, providing a seamless blend of ambient, task, and accent lighting. These luminous additions artfully enhance the aesthetics of any home, highlighting its architectural features and adding a distinctive touch to interior design.



# EMPIRE CHANDELIERS

**60-356**

Brushed Nickel / Alabaster Glass



6 Lt. Chandelier

60W A19 max. / Medium Base

Dimensions: Width 26", Height 14"

25-1069 3' Section of matching chain

**60-358**

Old Bronze / Alabaster Glass



6 Lt. Chandelier

60W A19 max. / Medium Base

Dimensions: Width 26", Height 14"

25-1067 3' Section of matching chain

12' OF WIRE AND 3' OF CHAIN SUPPLIED

**60-3255**

Brushed Nickel / Frosted Glass



6 Lt. Chandelier

60W A19 max. / Medium Base

Dimensions: Width 26", Height 14"

25-1069 3' Section of matching chain

**60-3169**

Mahogany Bronze / Frosted Glass



6 Lt. Chandelier

60W A19 max. / Medium Base

Dimensions: Width 26", Height 14"

25-2081 3' Section of matching chain

# BALLERINA CHANDELIERS

**60-181**

Brushed Nickel / Alabaster Glass



5 Lt. Chandelier

60W A19 max. / Medium Base  
Dimensions: Width 24", Height 18"  
25-1069 3' Section of matching chain

**60-182**

Brushed Nickel / Alabaster Glass



3 Lt. Chandelier

60W A19 max. / Medium Base  
Dimensions: Width 20", Height 17"  
25-1069 3' Section of matching chain

**60-183**

Old Bronze / Alabaster Glass



5 Lt. Chandelier

60W A19 max. / Medium Base  
Dimensions: Width 24", Height 18"  
25-1067 3' Section of matching chain

**60-184**

Old Bronze / Alabaster Glass



3 Lt. Chandelier

60W A19 max. / Medium Base  
Dimensions: Width 20", Height 17"  
25-1067 3' Section of matching chain

**60-3141**

Mahogany Bronze / Frosted Glass



5 Lt. Chandelier

60W A19 max. / Medium Base  
Dimensions: Width 24", Height 18"  
25-2081 3' Section of matching chain

**60-3142**

Mahogany Bronze / Frosted Glass



3 Lt. Chandelier

60W A19 max. / Medium Base  
Dimensions: Width 20", Height 17"  
25-2081 3' Section of matching chain

**60-3240**

Brushed Nickel / Frosted Glass



3 Lt. Chandelier

60W A19 max. / Medium Base  
Dimensions: Width 24", Height 18"  
25-1069 3' Section of matching chain

**60-3241**

Brushed Nickel / Frosted Glass



3 Lt. Chandelier

60W A19 max. / Medium Base  
Dimensions: Width 20", Height 17"  
25-1069 3' Section of matching chain

# CLOSE-TO-CEILING

## 60-202

Brushed Nickel / Alabaster Glass



15" SEMI-FLUSH Convertible to Pendant

(3) 60W A19 max. / Medium Base  
Dimensions: Width 15.25", Height 15.5", Wire 12'  
Accessories:  
25-1403 Pendant conversion kit  
25-1069 3' Section of matching chain

## 60-3246

Brushed Nickel / Frosted Glass



15" SEMI-FLUSH Convertible to Pendant

(3) 60W A19 max. / Medium Base  
Dimensions: Width 15.25", Height 15.5", Wire 12'  
Accessories:  
25-1403 Pendant conversion kit  
25-1069 3' Section of matching chain

## 60-201

Brushed Nickel / Alabaster Glass



13" SEMI-FLUSH Convertible to Pendant

(2) 60W A19 max. / Medium Base  
Dimensions: Width 13.25", Height 14", Wire 12'  
Accessories:  
25-1403 Pendant conversion kit  
25-1069 3' Section of matching chain

## 60-3245

Brushed Nickel / Frosted Glass



13" SEMI-FLUSH Convertible to Pendant

(2) 60W A19 max. / Medium Base  
Dimensions: Width 13.25", Height 14", Wire 12'  
Accessories:  
25-1403 Pendant conversion kit  
25-1069 3' Section of matching chain

## 60-200

Brushed Nickel / Alabaster Glass



11" SEMI-FLUSH Convertible to Pendant

(2) 60W A19 max. / Medium Base  
Dimensions: Width 11.375", Height 12", Wire 12'  
Accessories:  
25-1403 Pendant conversion kit  
25-1069 3' Section of matching chain

## 60-3244

Brushed Nickel / Frosted Glass



11" SEMI-FLUSH Convertible to Pendant

(2) 60W A19 max. / Medium Base  
Dimensions: Width 11.375", Height 12", Wire 12'  
Accessories:  
25-1403 Pendant conversion kit  
25-1069 3' Section of matching chain

**60-210**

Old Bronze / Alabaster Glass



15" SEMI-FLUSH Convertible to Pendant  
(3) 60W A19 max. / Medium Base  
Dimensions: Width 15.25", Height 15.5", Wire 12'  
Accessories:  
25-1402 Pendant conversion kit  
25-1067 3' Section of matching chain

**60-3151**

Mahogany Bronze / Frosted Glass



15" SEMI-FLUSH Convertible to Pendant  
(3) 60W A19 max. / Medium Base  
Dimensions: Width 15.25", Height 15.5", Wire 12'  
Accessories:  
25-2082 Pendant conversion kit  
25-2081 3' Section of matching chain

**60-209**

Old Bronze / Alabaster Glass



13" SEMI-FLUSH Convertible to Pendant  
(2) 60W A19 max. / Medium Base  
Dimensions: Width 13.25", Height 14", Wire 12'  
Accessories:  
25-1402 Pendant conversion kit  
25-1067 3' Section of matching chain

**60-3149**

Mahogany Bronze / Frosted Glass



13" SEMI-FLUSH Convertible to Pendant  
(2) 60W A19 max. / Medium Base  
Dimensions: Width 13.25", Height 14", Wire 12'  
Accessories:  
25-2082 Pendant conversion kit  
25-2081 3' Section of matching chain

**60-208**

Old Bronze / Alabaster Glass



11" SEMI-FLUSH Convertible to Pendant  
(2) 60W A19 max. / Medium Base  
Dimensions: Width 11.375", Height 12", Wire 12'  
Accessories:  
25-1402 Pendant conversion kit  
25-1067 3' Section of matching chain

**60-3148**

Mahogany Bronze / Frosted Glass



11" SEMI-FLUSH Convertible to Pendant  
(2) 60W A19 max. / Medium Base  
Dimensions: Width 11.375", Height 12", Wire 12'  
Accessories:  
25-2082 Pendant conversion kit  
25-2081 3' Section of matching chain

# CLOSE-TO-CEILING

**60-207**

Old Bronze / Alabaster Glass



15" FLUSH MOUNT

(3) 60W A19 max. / Medium Base  
Dimensions: Width 15.25", Height 6"  
CUL damp location

**60-3147**

Mahogany Bronze / Frosted Glass



15" FLUSH MOUNT

(3) 60W A19 max. / Medium Base  
Dimensions: Width 15.25", Height 6"  
CUL damp location

**60-206**

Old Bronze / Alabaster Glass



13" FLUSH MOUNT

(2) 60W A19 max. / Medium Base  
Dimensions: Width 13.25", Height 5.375"  
CUL damp location

**60-3146**

Mahogany Bronze / Frosted Glass



13" FLUSH MOUNT

(2) 60W A19 max. / Medium Base  
Dimensions: Width 13.25", Height 5.375"  
CUL damp location

**60-205**

Old Bronze / Alabaster Glass



11" FLUSH MOUNT

(2) 60W A19 max. / Medium Base  
Dimensions: Width 11.375", Height 4.875"  
CUL damp location

**60-3145**

Mahogany Bronze / Frosted Glass



11" FLUSH MOUNT

(2) 60W A19 max. / Medium Base  
Dimensions: Width 11.375", Height 4.875"  
CUL damp location

**60-199**

Brushed Nickel / Alabaster Glass



15" FLUSH MOUNT

(3) 60W A19 max. / Medium Base  
Dimensions: Width 15.25", Height 6"  
CUL damp location

**60-3263**

Brushed Nickel / Frosted Glass



15" FLUSH MOUNT

(3) 60W A19 max. / Medium Base  
Dimensions: Width 15.25", Height 6"  
CUL damp location

**60-198**

Brushed Nickel / Alabaster Glass



13" FLUSH MOUNT

(2) 60W A19 max. / Medium Base  
Dimensions: Width 13.25", Height 5.375"  
CUL damp location

**60-3262**

Brushed Nickel / Frosted Glass



13" FLUSH MOUNT

(2) 60W A19 max. / Medium Base  
Dimensions: Width 13.25", Height 5.375"  
CUL damp location

**60-197**

Brushed Nickel / Alabaster Glass



11" FLUSH MOUNT

(2) 60W A19 max. / Medium Base  
Dimensions: Width 11.375", Height 4.875"  
CUL damp location

**60-3261**

Brushed Nickel / Frosted Glass



11" FLUSH MOUNT

(2) 60W A19 max. / Medium Base  
Dimensions: Width 11.375", Height 4.875"  
CUL damp location

# CLOSE-TO-CEILING

## 60-283

Brushed Nickel / Alabaster Glass



12" TWIST AND LOCK

(1) 60W A19 max. / Medium Base  
Dimensions: Width 11.5", Height 4.5"  
CUL damp location

## 60-284

Brushed Nickel / Alabaster Glass



14" TWIST AND LOCK

(2) 60W A19 max. / Medium Base  
Dimensions: Width 14", Height 5.5"  
CUL damp location

## 60-285

Brushed Nickel / Alabaster Glass



17" TWIST AND LOCK

(3) 60W A19 max. / Medium Base  
Dimensions: Width 17", Height 6"  
CUL damp location

## 60-3271

Brushed Nickel / Frosted Glass



12" TWIST AND LOCK

(1) 60W A19 max. / Medium Base  
Dimensions: Width 11.5", Height 4.5"  
CUL damp location

## 60-3272

Brushed Nickel / Frosted Glass



14" TWIST AND LOCK

(2) 60W A19 max. / Medium Base  
Dimensions: Width 14", Height 5.5"  
CUL damp location

## 60-3273

Brushed Nickel / Frosted Glass



17" TWIST AND LOCK

(3) 60W A19 max. / Medium Base  
Dimensions: Width 17", Height 6"  
CUL damp location

## 60-270

Brushed Nickel / Alabaster Glass



12" TRI-CLIP FLUSH MOUNT

(1) 60W A19 max. / Medium Base  
Dimensions: Width 12.5", Height 4"  
CUL damp location

## 60-271

Brushed Nickel / Alabaster Glass



16" TRI-CLIP FLUSH MOUNT

(2) 60W A19 max. / Medium Base  
Dimensions: Width 16.125", Height 5"  
CUL damp location

**60-3177**

Mahogany Bronze / Frosted Glass



17" TWIST AND LOCK

(3) 60W A19 max. / Medium Base  
Dimensions: Width 17", Height 6"  
CUL damp location

**60-282**

Old Bronze / Alabaster Glass



17" TWIST AND LOCK

(3) 60W A19 max. / Medium Base  
Dimensions: Width 17", Height 6"  
CUL damp location

**60-3176**

Mahogany Bronze / Frosted Glass



14" TWIST AND LOCK

(2) 60W A19 max. / Medium Base  
Dimensions: Width 14", Height 5.5"  
CUL damp location

**60-281**

Old Bronze / Alabaster Glass



14" TWIST AND LOCK

(2) 60W A19 max. / Medium Base  
Dimensions: Width 14", Height 5.5"  
CUL damp location

**60-3175**

Mahogany Bronze / Frosted Glass



12" TWIST AND LOCK

(1) 60W A19 max. / Medium Base  
Dimensions: Width 11.5", Height 4.5"  
CUL damp location

**60-280**

Old Bronze / Alabaster Glass



12" TWIST AND LOCK

(1) 60W A19 max. / Medium Base  
Dimensions: Width 11.5", Height 4.5"  
CUL damp location

# CLOSE-TO-CEILING

**60-127**

Matte Black / Opal Glass



11" FLUSH MOUNT

(3) 60W A19 max. / Medium Base  
Dimensions: Width 11.38", Height 4.88"  
CUL damp location

**76-245**

Brushed Nickel / Frosted Melon Glass



15" FLUSH MOUNT

(3) 60W A19 max. / Medium Base  
Dimensions: Width 15.25", Height 6"  
CUL damp location

**60-223**

Textured White / Alabaster Glass



15" FLUSH MOUNT

(3) 60W A19 max. / Medium Base  
Dimensions: Width 15.25", Height 6"  
CUL damp location

**60-128**

Matte Black / Opal Glass



13" FLUSH MOUNT

(2) 60W A19 max. / Medium Base  
Dimensions: Width 13.25", Height 5.38"  
CUL damp location

**76-244**

Brushed Nickel / Frosted Melon Glass



13" FLUSH MOUNT

(2) 60W A19 max. / Medium Base  
Dimensions: Width 13.25", Height 5.5"  
CUL damp location

**60-222**

Textured White / Alabaster Glass



13" FLUSH MOUNT

(2) 60W A19 max. / Medium Base  
Dimensions: Width 13.25", Height 5.38"  
CUL damp location

**60-129**

Matte Black / Opal Glass



15" FLUSH MOUNT

(2) 60W A19 max. / Medium Base  
Dimensions: Width 15.25", Height 6"  
CUL damp location

**76-243**

Brushed Nickel / Frosted Melon Glass



11" FLUSH MOUNT

(2) 60W A19 max. / Medium Base  
Dimensions: Width 11.25", Height 5"  
CUL damp location

**60-221**

Textured White / Alabaster Glass



11" FLUSH MOUNT

(2) 60W A19 max. / Medium Base  
Dimensions: Width 11.375", Height 4.88"  
CUL damp location

**76-128**  
Polished Brass / Frosted Melon Glass



15" FLUSH MOUNT  
(3) 60W A19 max. / Medium Base  
Dimensions: Width 15.25", Height 6"  
CUL damp location

**76-129**  
Textured White / Frosted Melon Glass



15" FLUSH MOUNT  
(3) 60W A19 max. / Medium Base  
Dimensions: Width 15.25", Height 6"  
CUL damp location

**76-126**  
Polished Brass / Frosted Melon Glass



13" FLUSH MOUNT  
(2) 60W A19 max. / Medium Base  
Dimensions: Width 13.25", Height 5.5"  
CUL damp location

**76-127**  
Textured White / Frosted Melon Glass



13" FLUSH MOUNT  
(2) 60W A19 max. / Medium Base  
Dimensions: Width 13.25", Height 5.5"  
CUL damp location

**76-124**  
Polished Brass / Frosted Melon Glass



11" FLUSH MOUNT  
(2) 60W A19 max. / Medium Base  
Dimensions: Width 11.25", Height 5"  
CUL damp location

**76-125**  
Textured White / Frosted Melon Glass



11" FLUSH MOUNT  
(2) 60W A19 max. / Medium Base  
Dimensions: Width 11.25", Height 5"  
CUL damp location

# CLOSE-TO-CEILING

**76-611**

Brushed Nickel / Clear Ribbed Glass



15" FLUSH MOUNT

(3) 60W A19 max. / Medium Base  
Dimensions: Width 15.25", Height 6"  
CUL damp location

**76-608**

Old Bronze / Clear Ribbed Glass



15" FLUSH MOUNT

(3) 60W A19 max. / Medium Base  
Dimensions: Width 15.25", Height 6"  
CUL damp location

**76-093**

Polished Brass / Clear Ribbed Glass



15" FLUSH MOUNT

(3) 60W A19 max. / Medium Base  
Dimensions: Width 15.25", Height 6"  
CUL damp location

**76-610**

Brushed Nickel / Clear Ribbed Glass



13" FLUSH MOUNT

(2) 60W A19 max. / Medium Base  
Dimensions: Width 13.25", Height 5.5"  
CUL damp location

**76-607**

Old Bronze / Clear Ribbed Glass



13" FLUSH MOUNT

(2) 60W A19 max. / Medium Base  
Dimensions: Width 13.25", Height 5.5"  
CUL damp location

**76-092**

Polished Brass / Clear Ribbed Glass



13" FLUSH MOUNT

(2) 60W A19 max. / Medium Base  
Dimensions: Width 13.25", Height 5.5"  
CUL damp location

**76-609**

Brushed Nickel / Clear Ribbed Glass



11" FLUSH MOUNT

(2) 60W A19 max. / Medium Base  
Dimensions: Width 11.25", Height 5"  
CUL damp location

**76-606**

Old Bronze / Clear Ribbed Glass



11" FLUSH MOUNT

(2) 60W A19 max. / Medium Base  
Dimensions: Width 11.25", Height 5"  
CUL damp location

**76-091**

Polished Brass / Clear Ribbed Glass



11" FLUSH MOUNT

(2) 60W A19 max. / Medium Base  
Dimensions: Width 11.25", Height 5"  
CUL damp location

**76-191**  
Textured White / Clear Ribbed Glass



11" FLUSH MOUNT  
(2) 60W A19 max. / Medium Base  
Dimensions: Width 11.25", Height 5"  
CUL damp location

**76-192**  
Textured White / Clear Ribbed Glass



13" FLUSH MOUNT  
(2) 60W A19 max. / Medium Base  
Dimensions: Width 13.25", Height 5.5"  
CUL damp location

**76-193**  
Textured White / Clear Ribbed Glass



15" FLUSH MOUNT  
(3) 60W A19 max. / Medium Base  
Dimensions: Width 15.25", Height 6"  
CUL damp location

**76-131**  
Textured White / Frosted Ribbed Glass



11" FLUSH MOUNT  
(2) 60W A19 max. / Medium Base  
Dimensions: Width 11.25", Height 5"  
CUL damp location

**76-133**  
Textured White / Frosted Ribbed Glass



13" FLUSH MOUNT  
(2) 60W A19 max. / Medium Base  
Dimensions: Width 13.25", Height 5.5"  
CUL damp location

**76-132**  
Polished Brass / Frosted Ribbed Glass



13" FLUSH MOUNT  
(2) 60W A19 max. / Medium Base  
Dimensions: Width 13.25", Height 5.5"  
CUL damp location

**76-130**  
Polished Brass / Frosted Ribbed Glass



11" FLUSH MOUNT  
(2) 60W A19 max. / Medium Base  
Dimensions: Width 11.25", Height 5"  
CUL damp location

**77-125**  
Polished Brass / Clear Pineapple Glass



CLEAR PINEAPPLE  
(1) 60W A19 max. / Medium Base  
Dimensions: Dia. 5", Height 5.5"  
CUL damp location

# CLOSE-TO-CEILING

**77-987**

White / White Glass



LARGE MUSHROOM

(2) 60W A19 max. / Medium Base  
Dimensions: Width 12", Height 6"  
CUL damp location

**76-604**

Old Bronze / White Glass



LARGE MUSHROOM

(2) 60W A19 max. / Medium Base  
Dimensions: Width 12", Height 6"  
CUL damp location

**77-062**

White / White Glass



MEDIUM MUSHROOM

(2) 60W A19 max. / Medium Base  
Dimensions: Width 9.5", Height 6"  
CUL damp location

**76-602**

Old Bronze / White Glass



MEDIUM MUSHROOM

(2) 60W A19 max. / Medium Base  
Dimensions: Width 9.5", Height 6"  
CUL damp location

**77-060**

White / White Glass



SMALL MUSHROOM

(1) 60W A19 max. / Medium Base  
Dimensions: Width 7.5", Height 5"  
CUL damp location

**76-600**

Old Bronze / White Glass



SMALL MUSHROOM

(1) 60W A19 max. / Medium Base  
Dimensions: Width 7.5", Height 5"  
CUL damp location

**76-676**  
Old Bronze / Alabaster Glass



LARGE MUSHROOM  
(2) 60W A19 max. / Medium Base  
Dimensions: Width 12", Height 6"  
CUL damp location

**76-677**  
Brushed Nickel / Alabaster Glass



LARGE MUSHROOM  
(2) 60W A19 max. / Medium Base  
Dimensions: Width 12", Height 6"  
CUL damp location

**76-673**  
Old Bronze / Alabaster Glass



MEDIUM MUSHROOM  
(2) 60W A19 max. / Medium Base  
Dimensions: Width 9.5", Height 6"  
CUL damp location

**76-674**  
Brushed Nickel / Alabaster Glass



MEDIUM MUSHROOM  
(2) 60W A19 max. / Medium Base  
Dimensions: Width 9.5", Height 6"  
CUL damp location

**76-670**  
Old Bronze / Alabaster Glass



SMALL MUSHROOM  
(1) 60W A19 max. / Medium Base  
Dimensions: Width 7.5", Height 5"  
CUL damp location

**76-671**  
Brushed Nickel / Alabaster Glass



SMALL MUSHROOM  
(1) 60W A19 max. / Medium Base  
Dimensions: Width 7.5", Height 5"  
CUL damp location

# CLOSE-TO-CEILING

**76-605**

Brushed Nickel / White Glass



LARGE MUSHROOM

(2) 60W A19 max. / Medium Base  
Dimensions: Width 12", Height 6"  
CUL damp location

**76-253**

White / Clear Ribbed Glass



10" MUSHROOM FLUSH

(2) 60W A19 max. / Medium Base  
Dimensions: Width 9.5", Height 6"  
CUL damp location

**76-603**

Brushed Nickel / White Glass



MEDIUM MUSHROOM

(2) 60W A19 max. / Medium Base  
Dimensions: Width 9.5", Height 6"  
CUL damp location

**76-251**

White / Clear Ribbed Glass



8" MUSHROOM FLUSH

(1) 60W A19 max. / Medium Base  
Dimensions: Width 7.5", Height 5"  
CUL damp location

**76-601**

Brushed Nickel / White Glass



SMALL MUSHROOM

(1) 60W A19 max. / Medium Base  
Dimensions: Width 7.5", Height 5"  
CUL damp location

**76-257**

White / Clear Ribbed Glass



6" BALL

(1) 60W A19 max. / Medium Base  
Dimensions: Width 6", Height 7.25"  
CUL damp location

**60-3249**  
Brushed Nickel / Frosted Glass



6" BALL

(1) 60W A19 max. / Medium Base  
Dimensions: Width 6", Height 7.25"  
CUL damp location

**77-108**  
Polished Brass / White Glass



6" BALL

(1) 60W A19 max. / Medium Base  
Dimensions: Width 6", Height 7.25"  
CUL damp location

**60-245**  
Brushed Nickel / White Glass



6" BALL

(1) 60W A19 max. / Medium Base  
Dimensions: Width 6", Height 7.25"  
CUL damp location

**77-947**  
White / White Glass



6" BALL

(1) 60W A19 max. / Medium Base  
Dimensions: Width 6", Height 7.25"  
CUL damp location

**60-247**  
Old Bronze / White Glass



6" BALL

(1) 60W A19 max. / Medium Base  
Dimensions: Width 6", Height 7.25"  
CUL damp location

**60-295**  
Polished Brass / White Glass



6" BALL

(1) 60W A19 max. / Medium Base  
Dimensions: Width 6", Height 7.25"  
CUL damp location

**60-712**  
White / White Glass



6" FLUSH (BALL) with Pull Chain Switch

(1) 60W A19 max. / Medium Base  
Dimensions: Dia. 6", Height 7.25"  
CUL damp location

**60-257**  
Brushed Nickel / Alabaster Glass



6" FLUSH MOUNT

(1) 60W A19 max. / Medium Base  
Dimensions: Width 6", Height 7.25"  
CUL damp location

# CLOSE-TO-CEILING

**60-4801**  
Brushed Nickel



DUAL SURFACE MOUNT (CEILING OR WALL)

(1) 60W max. / Medium Base - LAMP NOT INCLUDED  
Dimensions: Dia. 5", Ext. 2.375" (less lamp)  
CUL damp location

**60-4802**  
Polished Nickel



DUAL SURFACE MOUNT (CEILING OR WALL)

(1) 60W max. / Medium Base - LAMP NOT INCLUDED  
Dimensions: Dia. 5", Ext. 2.375" (less lamp)  
CUL damp location

**60-4803**  
White



STYLE SOCKET (CEILING OR WALL)

(1) 60W max. / Medium Base - LAMP NOT INCLUDED  
Dimensions: Dia. 5", Ext. 2.375" (less lamp)  
CUL damp location

**60-4804**  
Dark Bronze



STYLE SOCKET (CEILING OR WALL)

(1) 60W max. / Medium Base - LAMP NOT INCLUDED  
Dimensions: Dia. 5", Ext. 2.375" (less lamp)  
CUL damp location

**77-102**  
Polished Chrome / Crystal & White Glass



LARGE FLUSH (DRUM)  
(2) 60W A19 max. / Medium Base  
Dimensions: Dia. 10", Height 7"  
CUL damp location

**77-099**  
White / Crystal & White Glass



LARGE FLUSH (DRUM)  
(2) 60W A19 max. / Medium Base  
Dimensions: Dia. 10", Height 7"  
CUL damp location

**77-101**  
Polished Chrome / Crystal & White Glass



MEDIUM FLUSH (DRUM)  
(2) 60W A19 max. / Medium Base  
Dimensions: Dia. 8", Height 6"  
CUL damp location

**77-098**  
White / Crystal & White Glass



MEDIUM FLUSH (DRUM)  
(2) 60W A19 max. / Medium Base  
Dimensions: Dia. 8", Height 6"  
CUL damp location

**77-100**  
Polished Chrome / Crystal & White Glass



SMALL FLUSH (DRUM)  
(1) 60W A19 max. / Medium Base  
Dimensions: Dia. 6", Height 5"  
CUL damp location

**77-097**  
White / Crystal & White Glass



SMALL FLUSH (DRUM)  
(1) 60W A19 max. / Medium Base  
Dimensions: Dia. 6", Height 5"  
CUL damp location

# CLOSE-TO-CEILING

**76-270**  
White Holder



**SQUARE WHEAT DESIGN**  
with RUFFLED EDGE  
(2) 60W A19 max. / Medium Base  
Dimensions: Width 11.75", Height 4.75"  
CUL damp location

**77-126**  
White Holder



**SQUARE FLORAL DESIGN**  
(2) 60W A19 max. / Medium Base  
Dimensions: Width 11.75", Height 4.75"  
CUL damp location

**77-823**  
White Holder



**ROUND WHITE**  
(2) 60W A19 max. / Medium Base  
Dimensions: Width 12", Height 4.75"  
CUL damp location

**77-824**  
White Holder



**SQUARE WHITE**  
(2) 60W A19 max. / Medium Base  
Dimensions: Width 11.75", Height 4.75"  
CUL damp location

**76-268**  
White Holder



**ROUND GRAPE DESIGN**  
(2) 60W A19 max. / Medium Base  
Dimensions: Width 12", Height 4.75"  
CUL damp location

**76-269**  
White Holder



**ROUND SUNBURST DESIGN**  
(2) 60W A19 max. / Medium Base  
Dimensions: Width 12", Height 4.75"  
CUL damp location

**77-392**  
White Holder



**SQUARE FLORAL DESIGN**  
with Pull Chain Switch  
(2) 60W A19 max. / Medium Base  
Dimensions: Width 11.75", Height 4.75"  
CUL damp location

**76-412**  
White / Black Baffle



R20 / PAR20 1 LIGHT | STRAIGHT CYLINDER  
(1) 50W R20 / PAR20 Halogen max. / Medium Base  
Dimensions: Height 8.5", Dia. 3.5"  
CETL US damp location

**76-416**  
White / Black Baffle



R20 / PAR20 3 LIGHT | STRAIGHT CYLINDER  
(3) 50W R20 / PAR20 Halogen max. / Medium Base  
Dimensions: Height 8.5", Width 14"  
CETL US damp location

**76-418**  
White / Black Baffle



R30 / PAR30 1 LIGHT | STRAIGHT CYLINDER  
(1) 75W R30 / 50W PAR30 Halogen max. / Medium Base  
Dimensions: Height 9.25", Dia. 4.5"  
CETL US damp location

**76-422**  
White / Black Baffle



R30 / PAR30 3 LIGHT | STRAIGHT CYLINDER  
(3) 75W R30 / 50W PAR30 Halogen max. / Medium Base  
Dimensions: Height 10", Dia. 18",  
CETL US damp location

# PENDANTS

**60-204**

Brushed Nickel / Alabaster Glass



20" PENDANT

(3) 60W A19 max. / Medium Base  
Dimensions: Dia. 20", Height 27.75", Chain 48", Wire 12'  
Accessories:

**25-1069** 3' Section of matching chain

**60-203**

Brushed Nickel / Alabaster Glass



15" PENDANT

(3) 60W A19 max. / Medium Base  
Dimensions: Dia. 15", Height 23", Chain 48", Wire 12'  
Accessories:

**25-1069** 3' Section of matching chain

**60-370**

Brushed Nickel / Alabaster Glass



THREE LIGHT PENDANT

(3) 60W A19 max. / Medium Base  
Dimensions: Dia. 20.5", Height 22.5", Chain 48", Wire 12'  
Accessories:

**25-1069** 3' Section of Brushed Nickel chain

**60-371**

Old Bronze / Alabaster Glass



THREE LIGHT PENDANT

(3) 60W A19 max. / Medium Base  
Dimensions: Dia. 20.5", Height 22.5", Chain 48", Wire 12'  
Accessories:

**25-1067** 3' Section of Old Bronze chain

**60-390**

Brushed Nickel / Alabaster Glass



HANGING DOME

(1) 100W A19 max. / Medium Base  
Dimensions: Dia. 16", Height 11.5", Chain 48", Wire 12'  
Accessories:

**25-1069** 3' Section of matching chain

**60-3173**

Mahogany Bronze / Alabaster Glass



HANGING DOME

(1) 100W A19 max. / Medium Base  
Dimensions: Dia. 16", Height 11.5", Chain 48", Wire 12'  
Accessories:

**25-2081** 3' Section of matching chain

**60-3258**

Brushed Nickel / Frosted Glass



HANGING DOME

(1) 100W A19 max. / Medium Base  
Dimensions: Dia. 16", Height 11.5", Chain 48", Wire 12'  
Accessories:  
**25-1069** 3' Section of matching chain

**60-391**

Old Bronze / Alabaster Glass



HANGING DOME

(1) 100W A19 max. / Medium Base  
Dimensions: Dia. 16", Height 11.5", Chain 48", Wire 12'  
Accessories:  
**25-1067** 3' Section of matching chain

**60-394**

Brushed Nickel / Alabaster Glass



PENDANT BELL

(1) 100W A19 max. / Medium Base  
Dimensions: Dia. 9.75", Height 20.5", Chain 48", Wire 12'  
Accessories:  
**25-1069** 3' Section of matching chain

**60-395**

Old Bronze / Alabaster Glass



PENDANT BELL

(1) 100W A19 max. / Medium Base  
Dimensions: Dia. 9.75", Height 20.5", Chain 48", Wire 12'  
Accessories:  
**25-1067** 3' Section of matching chain

**60-3259**

Brushed Nickel / Frosted Glass



PENDANT BELL

(1) 100W A19 max. / Medium Base  
Dimensions: Dia. 9.75", Height 20.5", Chain 48", Wire 12'  
Accessories:  
**25-1069** 3' Section of matching chain

**60-3174**

Mahogany Bronze / Frosted Glass



PENDANT BELL

(1) 100W A19 max. / Medium Base  
Dimensions: Dia. 9.75", Height 20.5", Chain 48", Wire 12'  
Accessories:  
**25-2081** 3' Section of matching chain

# EMPIRE MINI PENDANTS

**60-365**

Brushed Nickel / Alabaster Glass



MINI PENDANT with hang-straight canopy

(1) 100W A19 max. / Medium Base  
Dimensions: Width 7", Height 6.5"

Accessories:  
Additional Stem Lengths  
**25-2047** (6"), **25-2021** (12")

**60-3172**

Mahogany Bronze / Frosted Glass



MINI PENDANT with hang-straight canopy

(1) 100W A19 max. / Medium Base  
Dimensions: Width 7", Height 6.5"

Accessories:  
Additional Stem Lengths  
**25-2078** (6"), **25-2079** (12")

**60-366**

Old Bronze / Alabaster Glass



MINI PENDANT with hang-straight canopy

(1) 100W A19 max. / Medium Base  
Dimensions: Width 7", Height 6.5"

Accessories:  
Additional Stem Lengths  
**25-2028** (6"), **25-2002** (12")

**60-3257**

Brushed Nickel / Frosted Glass



MINI PENDANT with hang-straight canopy

(1) 100W A19 max. / Medium Base  
Dimensions: Width 7", Height 6.5"

Accessories:  
Additional Stem Lengths  
**25-2047** (6"), **25-2021** (12")

EMPIRE PENDANTS AVAILABLE WITH HANG-STRAIGHT CANOPIES 12' OF WIRE SUPPLIED

# WAREHOUSE PENDANTS

**76-661**  
Brushed Nickel



WAREHOUSE SHADE  
(1) 100W A19 max. / Medium Base  
Dimensions: Width 16", Height 8.13", Cord 12'

**76-283**  
White



WAREHOUSE SHADE  
(1) 100W A19 max. / Medium Base  
Dimensions: Width 16", Height 8.13", Cord 12'

**76-662**  
Old Bronze



WAREHOUSE SHADE  
(1) 100W A19 max. / Medium Base  
Dimensions: Width 16", Height 8.13", Cord 12'

**76-284**  
Black



WAREHOUSE SHADE  
(1) 100W A19 max. / Medium Base  
Dimensions: Width 16", Height 8.13", Cord 12'

**76-663**  
Red



WAREHOUSE SHADE  
(1) 100W A19 max. / Medium Base  
Dimensions: Width 16", Height 8.13", Cord 12'

**76-660**  
Green



WAREHOUSE SHADE  
(1) 100W A19 max. / Medium Base  
Dimensions: Width 16", Height 8.13", Cord 12'

# BALLERINA VANITIES

## TWO LIGHT 18"



60-320  
Brushed Nickel/  
Alabaster Glass

(2) 100W A19 max. / Medium Base  
Dimensions: Width 18", Height 7.63", Ext. 8.5"

### Alabaster Glass



60-316  
Polished  
Chrome



60-324  
Old Bronze

### Frosted Glass



60-3278  
Brushed  
Nickel



60-3161  
Mahogany  
Bronze

## THREE LIGHT 24"



60-321  
Brushed Nickel/  
Alabaster Glass

(3) 100W A19 max. / Medium Base  
Dimensions: Width 24", Height 7.63", Ext. 8.5"

### Alabaster Glass



60-317  
Polished  
Chrome



60-325  
Old Bronze

### Frosted Glass



60-3279  
Brushed  
Nickel



60-3162  
Mahogany  
Bronze

## FOUR LIGHT 30"



60-322  
Brushed Nickel/  
Alabaster Glass

(4) 100W A19 max. / Medium Base  
Dimensions: Width 30", Height 7.63", Ext. 8.5"

### Alabaster Glass



60-318  
Polished  
Chrome



60-326  
Old Bronze

### Frosted Glass



60-3281  
Brushed  
Nickel



60-3163  
Mahogany  
Bronze

## FIVE LIGHT 36"



60-323  
Brushed Nickel/  
Alabaster Glass

(5) 100W A19 max. / Medium Base  
Dimensions: Width 36", Height 7.63", Ext. 8.5"

### Alabaster Glass



60-319  
Polished  
Chrome



60-327  
Old Bronze

### Frosted Glass



60-3282  
Brushed  
Nickel



60-3164  
Mahogany  
Bronze

## SEVEN LIGHT 48"



60-291  
Brushed Nickel/  
Alabaster Glass

(7) 100W A19 max. / Medium Base  
Dimensions: Width 48", Height 7.63", Ext. 8.5"

### Alabaster Glass



60-290  
Polished  
Chrome



60-292  
Old Bronze

### Frosted Glass



60-3283  
Brushed  
Nickel



60-3155  
Mahogany  
Bronze

UP OR DOWN INSTALLATION

# EMPIRE VANITIES

## ONE LIGHT 6"



60-340  
Brushed Nickel w/  
Alabaster Glass

(1) 100W A19 max. / Medium Base  
Dimensions: Width 6.25", Height 6.13", Ext. 9"

### Alabaster Glass



60-336  
Polished  
Chrome



60-344  
Old Bronze

### Frosted Glass



60-3264  
Brushed  
Nickel



60-3165  
Mahogany  
Bronze

## TWO LIGHT 15"



60-341  
Brushed Nickel w/  
Alabaster Glass

(2) 100W A19 max. / Medium Base  
Dimensions: Width 14.875", Height 6.13", Ext. 8"

### Alabaster Glass



60-337  
Polished  
Chrome



60-345  
Old Bronze

### Frosted Glass



60-3265  
Brushed  
Nickel



60-3166  
Mahogany  
Bronze

## THREE LIGHT 21"



60-342  
Brushed Nickel w/  
Alabaster Glass

(3) 100W A19 max. / Medium Base  
Dimensions: Width 20.5", Height 6.13", Ext. 8"

### Alabaster Glass



60-338  
Polished  
Chrome



60-346  
Old Bronze

### Frosted Glass



60-3266  
Brushed  
Nickel



60-3167  
Mahogany  
Bronze

## FOUR LIGHT 29"



60-343  
Brushed Nickel w/  
Alabaster Glass

(4) 100W A19 max. / Medium Base  
Dimensions: Width 28.75", Height 6.13", Ext. 8"

### Alabaster Glass



60-339  
Polished  
Chrome



60-347  
Old Bronze

### Frosted Glass



60-3277  
Brushed  
Nickel



60-3168  
Mahogany  
Bronze

UP OR DOWN INSTALLATION

# VANITIES

## THREE LIGHT 18"



60-300  
Brushed Nickel

(3) 100W Type G max. / Medium Base

Dimensions: Width 18", Height 4.75", Ext. 2" (less lamp)



60-296  
Polished Chrome



60-1284  
Mahogany Bronze

## FOUR LIGHT 24"



60-301  
Brushed Nickel

(4) 100W Type G max. / Medium Base

Dimensions: Width 24", Height 4.75", Ext. 2" (less lamp)



60-297  
Polished Chrome



60-1285  
Mahogany Bronze

## SIX LIGHT 36"



60-302  
Brushed Nickel

(6) 100W Type G max. / Medium Base

Dimensions: Width 36", Height 4.75", Ext. 2" (less lamp)



60-298  
Polished Chrome



60-1286  
Mahogany Bronze

## EIGHT LIGHT 48"



60-303  
Brushed Nickel

(8) 100W Type G max. / Medium Base

Dimensions: Width 48", Height 4.75", Ext. 2" (less lamp)



60-299  
Polished Chrome



60-1287  
Mahogany Bronze

**THREE LIGHT 18"**



77-188  
Polished Brass

(3) 100W Type G max. / Medium Base  
Dimensions: Width 18", Height 4.25", Ext. 2" (less lamp)

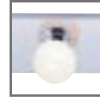

77-192  
Polished Chrome

**FOUR LIGHT 24"**



77-189  
Polished Brass

(4) 100W Type G max. / Medium Base  
Dimensions: Width 24", Height 4.25", Ext. 2" (less lamp)



77-193  
Polished Chrome

**SIX LIGHT 36"**



77-190  
Polished Brass

(6) 100W Type G max. / Medium Base  
Dimensions: Width 36", Height 4.25", Ext. 2" (less lamp)

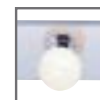

77-194  
Polished Chrome

**EIGHT LIGHT 48"**



77-191  
Polished Brass

(8) 100W Type G max. / Medium Base  
Dimensions: Width 48", Height 4.75", Ext. 2" (less lamp)

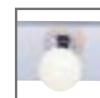

77-195  
Polished Chrome

# SCONCES

**60-044**

Old Bronze / Tuscan Suede Glass



TAPAS ONE LIGHT SCONCE  
(1) 60W A19 max. / Medium Base  
Dimensions: Width 12", Height 7", Ext. 6"  
(glass up installation only)

**60-5378**

Old Bronze / Alabaster Glass



BALLERINA ONE LIGHT SCONCE  
(1) 60W A19 max. / Medium Base  
Dimensions: Width 15.88", Height 7", Ext. 7.88"  
(glass up installation only)

**60-5381**

Brushed Nickel / Alabaster Glass



BALLERINA ONE LIGHT SCONCE  
(1) 60W A19 max. / Medium Base  
Dimensions: Width 15.88", Height 7", Ext. 7.88"  
(glass up installation only)

**60-5379**

Mahogany Bronze / Frosted Glass



BALLERINA ONE LIGHT SCONCE  
(1) 60W A19 max. / Medium Base  
Dimensions: Width 15.88", Height 7", Ext. 7.88"  
(glass up installation only)

**60-5382**

Brushed Nickel / Frosted Glass



BALLERINA ONE LIGHT SCONCE  
(1) 60W A19 max. / Medium Base  
Dimensions: Width 15.88", Height 7", Ext. 7.88"  
(glass up installation only)

**60-5374**  
Old Bronze / Alabaster Glass



EMPIRE ONE LIGHT SCONCE  
(1) 60W A19 max. / Medium Base  
Dimensions: Dia. 10", Height 9.63", Ext. 5"  
(glass up installation only)

**60-5376**  
Brushed Nickel / Alabaster Glass



EMPIRE ONE LIGHT SCONCE  
(1) 60W A19 max. / Medium Base  
Dimensions: Dia. 10", Height 9.63", Ext. 5"  
(glass up installation only)

**60-5375**  
Mahogany Bronze / Frosted Glass



EMPIRE ONE LIGHT SCONCE  
(1) 60W A19 max. / Medium Base  
Dimensions: Dia. 10", Height 9.63", Ext. 5"  
(glass up installation only)

**60-5377**  
Brushed Nickel / Frosted Glass



EMPIRE ONE LIGHT SCONCE  
(1) 60W A19 max. / Medium Base  
Dimensions: Dia. 10", Height 9.63", Ext. 5"  
(glass up installation only)

# VANITY / WALL FIXTURES

## 76-273

White / White Diamond Glass



7" "U" CHANNEL GLASS

(1) 60W A19 max. / Medium Base

Dimensions: Width 4.5", Height 7.5", Ext. 4.25"

## 76-276

White / White Diamond Glass



14" "U" CHANNEL GLASS

(2) 60W A19 max. / Medium Base

Dimensions: Width 14", Height 4.75", Ext. 4.25"

## 76-277

White / White Diamond Glass



24" "U" CHANNEL GLASS

(4) 60W A19 max. / Medium Base

Dimensions: Width 24", Height 4.75", Ext. 4.25"

## 77-086

White / White Glass



7" "U" CHANNEL GLASS

(1) 60W A19 max. / Medium Base

Dimensions: Width 4.5", Height 7.5", Ext. 4.25"

## 77-087

White / White Diamond Glass



14" "U" CHANNEL GLASS

(2) 60W A19 max. / Medium Base

Dimensions: Width 14", Height 4.75", Ext. 4.25"

## 77-088

White / White Diamond Glass



24" "U" CHANNEL GLASS

(4) 60W A19 max. / Medium Base

Dimensions: Width 24", Height 4.75", Ext. 4.25"

## 77-989

White / White Glass w/ Bottom Turn Switch



7" "U" CHANNEL GLASS

(1) 60W A19 max. / Medium Base

Dimensions: Width 4.5", Height 7.5", Ext. 4.25"

## 77-990

White / White Diamond Glass



14" "U" CHANNEL GLASS

(2) 60W A19 max. / Medium Base

Dimensions: Width 14", Height 4.75", Ext. 4.25"

## 77-991

White / White Diamond Glass



24" "U" CHANNEL GLASS

(4) 60W A19 max. / Medium Base

Dimensions: Width 24", Height 4.75", Ext. 4.25"

**77-121B**  
Chrome / White Glass, Crystal Bottom,  
with Convenience Outlet



CRYSTAL BOTTOM BATH SHADE  
(1) 60W A19 max. / Medium Base  
Dimensions: Width 4.75", Height 4.75", Ext. 6.75"

---

**77-120B**  
Polished Brass / Frosted Glass,  
with On-Off Switch



FROSTED GRAPE SHADE  
(1) 60W A19 max. / Medium Base  
Dimensions: Width 4.5", Height 7.75", Ext. 4.875"  
(glass up installation only)



# **FUNCTIONAL** solutions

## **DESIGN THAT DELIVERS**

BLINK's LED fixture program offers a diverse range of lighting solutions with a focus on quality and performance. Featuring a graceful design with die-cast aluminum construction, quick installation brackets, and compliance for reliability and adaptability in various settings



# BLINK® SERIES

## SETTING THE STANDARD IN PROFESSIONAL LIGHTING

BLINK's LED fixture program offers a diverse range of lighting solutions with a focus on quality and performance. Featuring a graceful design with die-cast aluminum construction, quick installation brackets, and compliance for reliability and adaptability in various settings.

### THE DIFFERENCE IS IN THE DRIVER

BLINK's external drivers boast advanced components that better regulate the electricity flowing to the LED chips, preventing electrical interference, overloading, and overheating. While some DOB (driver on board) flush mount fixtures may be an option, many don't offer the same level of performance, efficiency, and longevity as an external driver.

The external driver design extends the lifespan of our fixtures, setting them apart from DOB products that tend to experience premature driver failure and flickering due to inadequate filtering components. Furthermore, our external drivers are designed to match the precise needs of our LED fixtures, resulting in superior efficiency. Plus, the added components delivers improved dimming capabilities, which simply isn't possible to achieve with DOB designs due to limited space.



External Driver



Low Profile External Driver

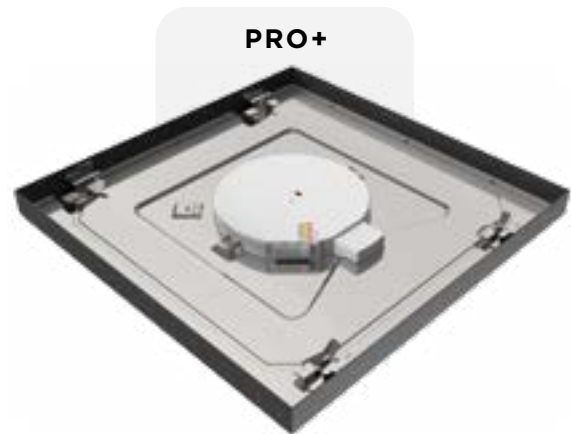

Low Profile External Driver

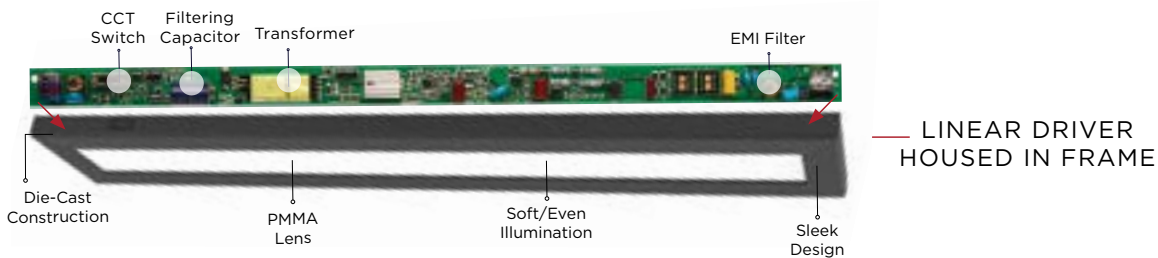

SCAN TO VIEW MORE INFORMATION ABOUT BLINK® SERIES

## BLINK® PRO | EM BATTERY BACKUP

In critical lighting situations, the BLINK® Pro EM Backup provides peace of mind while seamlessly integrating with the BLINK® Pro Series.

### EM SPECIFICATIONS

- Alert Function
- Test Indicator Combo Button
- 90 Minute Battery Run Time
- Quick-Snap Installation

- **Green:** Fully Charged
- **Blinking Red:** Service Battery
- **Red:** Indicates Charging

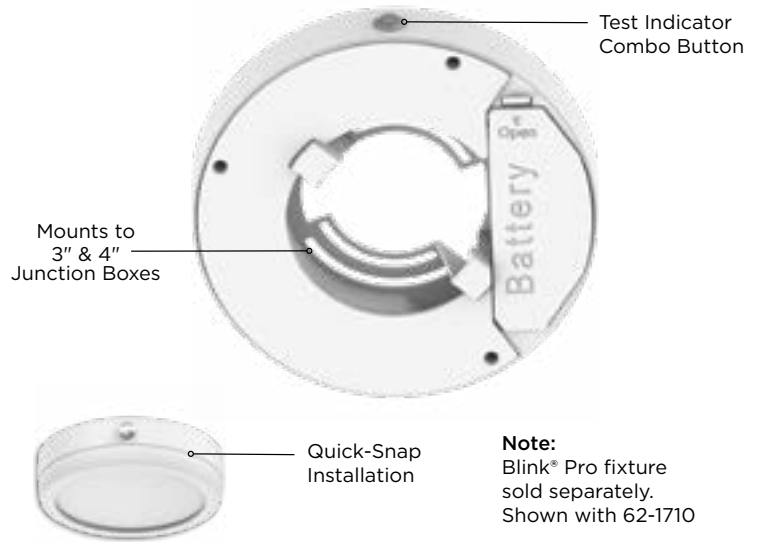

## BLINK® PRO | EXTENSION COLLARS

### SQUARE & ROUND OPTIONS

Extension Collars for shallow box installations or to match profile of BLINK® Pro with EM Models.

Extension Collars come in White, Black, Brushed Nickel and Bronze Finishes.

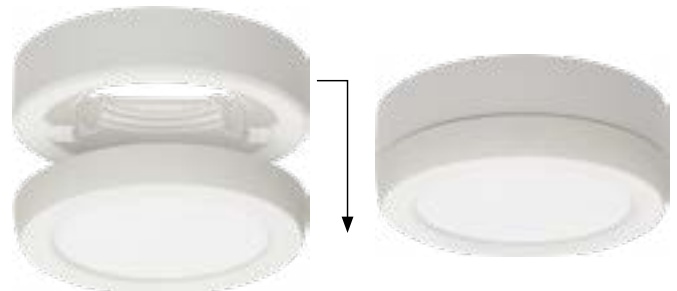

## BLINK® SERIES | MOUNTING BRACKETS | EASE OF INSTALLATION

The inclusion of a removable mounting bracket for all models simplifies the mounting procedure, allowing for quick and hassle-free installation. The fixture retaining clips effortlessly slide and lock into place on the mounting plates, ensuring a secure and solid fit. The end result is a clean and seamless appearance.

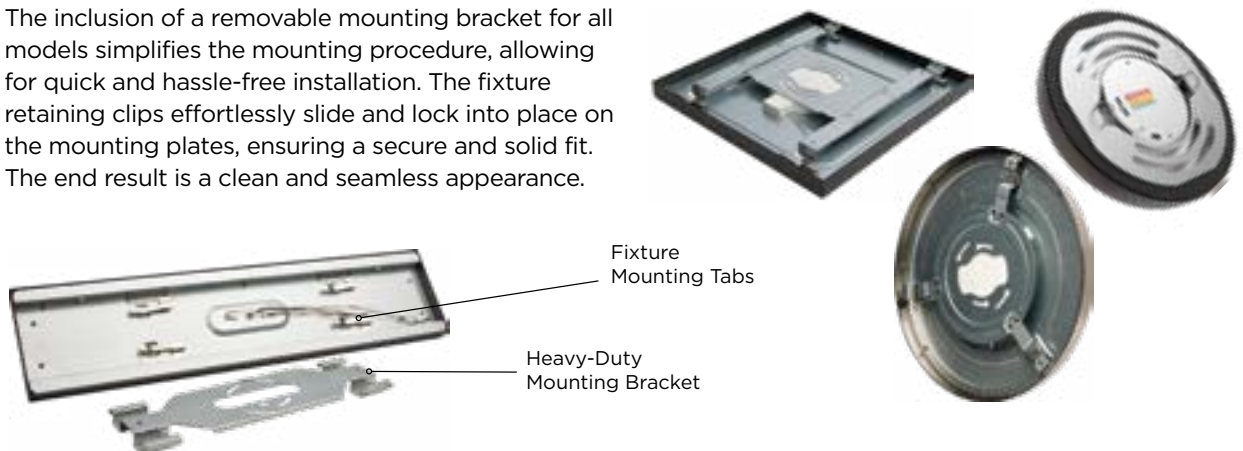

# BLINK® PRO

## ACCESSORIES

ITEM	SIZE	SHAPE	FINISH	WATTS	LUMENS	VOLTS	CLOSET RATED	EM BACKUP	REPLACEMENT BATTERY	EXTENSION COLLAR
62-1700	5"	Round	White	9W	700-780	120	✓	N/A	N/A	25-1700
62-1701	5"	Round	Black	9W	650-680	120	✓	N/A	N/A	25-1701
62-1702	5"	Round	Bronze	9W	650-680	120	✓	N/A	N/A	25-1702
62-1703	5"	Round	Br. Nickel	9W	650-680	120	✓	N/A	N/A	N/A
62-1710	7"	Round	White	11W	980-1050	120	✓	62-1710/EM	25-9004	25-1710
62-1711	7"	Round	Black	11W	900-950	120	✓	62-1711/EM	25-9004	25-1711
62-1712	7"	Round	Bronze	11W	900-950	120	✓	62-1712/EM	25-9004	25-1712
62-1713	7"	Round	Br. Nickel	11W	900-950	120	✓	62-1713/EM	25-9004	25-1713
62-1720	9"	Round	White	13W	1300-1320	120	•	62-1720/EM	25-9005	25-1720
62-1721	9"	Round	Black	13W	1200-1250	120	•	62-1721/EM	25-9005	25-1721
62-1722	9"	Round	Bronze	13W	1200-1250	120	•	62-1722/EM	25-9005	25-1722
62-1723	9"	Round	Br. Nickel	13W	1200-1250	120	•	62-1723/EM	25-9005	25-1723
62-1704	5"	Square	White	9W	680-730	120	✓	N/A	N/A	25-1704
62-1705	5"	Square	Black	9W	600-680	120	✓	N/A	N/A	25-1705
62-1706	5"	Square	Bronze	9W	600-680	120	✓	N/A	N/A	25-1706
62-1707	5"	Square	Br. Nickel	9W	600-680	120	✓	N/A	N/A	N/A
62-1714	7"	Square	White	11W	940-1000	120	✓	62-1714/EM	25-9004	25-1714
62-1715	7"	Square	Black	11W	800-850	120	✓	62-1715/EM	25-9004	25-1715
62-1716	7"	Square	Bronze	11W	800-850	120	✓	62-1716/EM	25-9004	25-1716
62-1717	7"	Square	Br. Nickel	11W	800-850	120	✓	62-1717/EM	25-9004	25-1717
62-1724	9"	Square	White	13W	1200-1300	120	•	62-1724/EM	25-9005	25-1724
62-1725	9"	Square	Black	13W	1032-1150	120	•	62-1725/EM	25-9005	25-1725
62-1726	9"	Square	Bronze	13W	1032-1150	120	•	62-1726/EM	25-9005	25-1726
62-1727	9"	Square	Br. Nickel	13W	1032-1150	120	•	62-1727/EM	25-9005	25-1727

✓ = 5" & 7" Comply for Zero Clearance Applications

• = Consult NEC Code for Dimensional Parameters for installation in clothes closets.

## Features

- Dimmable
- 5 CCT Selectable  
2700K/3000/3500/4000K/5000K
- Available in 120V and 120V/277V
- Emergency Backup Options
- Enhanced Driver Filtering
- Built-In 2.5KV Surge Protection
- Quick-Install Mounting Brackets
- Chamfered Bezel Die-Cast Construction



Complies with NEC 410.16(A)(3) & NEC 410.16(C) (5) Certified under UL 1598, suitable for clothes closet installation.

## FINISH OPTIONS



## BLINK® PRO | 0-10V EM CAPABLE

									ACCESSORIES		
ITEM	SIZE	SHAPE	FINISH	WATTS	LUMENS	CCT	VOLTS	CLOSET RATED	EM BACKUP	REPLACEMENT BATTERY	EXTENSION COLLAR
62-1746	7"	Round	White	11W	980	3000K	120-277	•	62-1746/EM	25-9004	25-1710
62-1748	7"	Round	White	11W	980	4000K	120-277	•	62-1746/EM	25-9004	25-1710
62-1756	9"	Round	White	13W	1300	3000K	120-277	•	62-1756/EM	25-9005	25-1720
62-1758	9"	Round	White	13W	1300	4000K	120-277	•	62-1756/EM	25-9005	25-1720
62-1747	7"	Square	White	11W	940	3000K	120-277	•	62-1747/EM	25-9004	25-1714
62-1749	7"	Square	White	11W	940	4000K	120-277	•	62-1747/EM	25-9004	25-1714
62-1757	9"	Square	White	13W	1200	3000K	120-277	•	62-1757/EM	25-9005	25-1724
62-1759	9"	Square	White	13W	1200	4000K	120-277	•	62-1757/EM	25-9005	25-1724

Only compatible with Blink® Pro 0-10V Emergency Battery Backup Units

• = Consult NEC Code for Dimensional Parameters for installation in clothes closets.

## BLINK® PRO | 0-10V NON-EM

ITEM	SIZE	SHAPE	FINISH	WATTS	LUMENS	CCT	VOLTS	EXTENSION COLLAR ACCESSORY	CLOSET RATED
62-1718	7"	Round	White	11W	980	3000K	120-277	25-1710	•
62-1733	7"	Round	White	11W	980	4000K	120-277	25-1710	•
62-1728	9"	Round	White	13W	1300	3000K	120-277	25-1720	•
62-1743	9"	Round	White	13W	1300	4000K	120-277	25-1720	•
62-1719	7"	Square	White	11W	940	3000K	120-277	25-1714	•
62-1734	7"	Square	White	11W	940	4000K	120-277	25-1714	•
62-1729	9"	Square	White	13W	1200	3000K	120-277	25-1724	•
62-1744	9"	Square	White	13W	1200	4000K	120-277	25-1724	•

• = Consult NEC Code for Dimensional Parameters for installation in clothes closets.

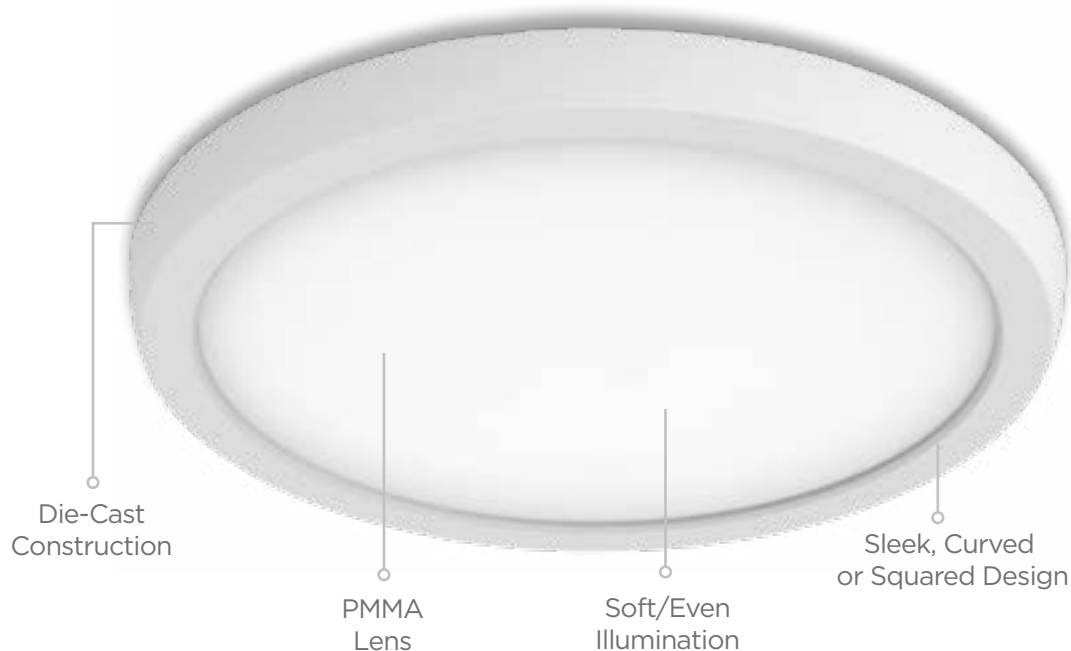

# BLINK® PRO+

ITEM	SIZE	SHAPE	FINISH	WATTS	LUMENS	VOLTS
62-1776	D:12"	Round	White	19.5W	1450-1520	120-277
62-1777	D:15"	Round	White	29W	2200-2320	120-277
62-1778	D:19"	Round	White	34W	2600-2740	120-277
62-1786	D:12"	Round	Black	19.5W	1350-1420	120-277
62-1787	D:15"	Round	Black	29.5W	2100-2220	120-277
62-1788	D:19"	Round	Black	34W	2500-2640	120-277
62-1796	D:12"	Round	Brushed Nickel	19.5W	1350-1470	120-277

## Applications

- Kitchen
- Bathroom
- Hallway
- Office
- Utility



## Features

- Dimmable
- 5 CCT Selectable  
2700K/3000/3500/4000K/5000K
- Built-In 2.5KV Surge Protection
- Enhanced Driver Filtering
- Quick-Install Mounting Brackets
- Chamfered Bezel Die-Cast Construction
- Offered in Large Diameter, Square, or Linear Models



## FINISH OPTIONS



White



Black



Brushed Nickel

ITEM	SIZE	SHAPE	FINISH	WATTS	LUMENS	VOLTS
62-1779	L:12" W:12"	Square	White	19.5W	1400-1470	120-277
62-1789	L:12" W:12"	Square	Black	19.5W	1300-1370	120-277
62-1799	L:12" W:12"	Square	Brushed Nickel	19.5W	1300-1410	120-277
62-1774	L:24" W:24"	Square	White	47W	3600-4050	120-277
62-1784	L:24" W:24"	Square	Black	47W	3550-3900	120-277
62-1770	L:24" W:5.5"	Rectangular	White	24W	1650-1870	120-277
62-1771	L:36" W:5.5"	Rectangular	White	32W	2150-2400	120-277
62-1772	L:48" W:5.5"	Rectangular	White	42W	2850-3100	120-277
62-1780	L:24" W:5.5"	Rectangular	Black	24W	1600-1750	120-277
62-1781	L:36" W:5.5"	Rectangular	Black	32W	2100-2300	120-277
62-1782	L:48" W:5.5"	Rectangular	Black	42W	2800-2950	120-277
62-1773	L:12" W:24"	Rectangular	White	24W	1650-1900	120-277
62-1775	L:12" W:48"	Rectangular	White	47W	3500-4050	120-277
62-1783	L:12" W:24"	Rectangular	Black	24W	1650-1850	120-277
62-1785	L:12" W:48"	Rectangular	Black	47W	3450-3800	120-277



# BLINK® PERFORMER

ITEM	SIZE	SHAPE	FINISH	WATTS	LUMENS	VOLTS
62-1900	5"	Round	White	8W	700-730	120
62-1901	5"	Round	Black	8W	650-680	120
62-1902	5"	Round	Bronze	8W	650-680	120
62-1903	5"	Round	Brushed Nickel	8W	650-680	120
62-1910	7"	Round	White	10W	900-980	120
62-1911	7"	Round	Black	10W	850-930	120
62-1912	7"	Round	Bronze	10W	850-930	120
62-1913	7"	Round	Brushed Nickel	10W	850-930	120
62-1920	9"	Round	White	11W	1050-1150	120
62-1921	9"	Round	Black	11W	1000-1050	120
62-1922	9"	Round	Bronze	11W	1000-1050	120
62-1923	9"	Round	Brushed Nickel	11W	1000-1050	120

## Applications

- Kitchen
- Bathroom
- Hallway
- Office
- Utility



## Features

- Dimmable
- 5 CCT Selectable  
2700K/3000/3500/4000K/5000K
- Built-In 2.5KV Surge Protection
- Enhanced Driver Filtering
- Quick-Install Mounting Brackets
- Chamfered Bezel Die-Cast Construction
- Flat Back Design



## FINISH OPTIONS



White



Black



Bronze



Brushed Nickel



ITEM	SIZE	SHAPE	FINISH	WATTS	LUMENS	VOLTS
62-1904	5"	Square	White	8W	680-730	120
62-1905	5"	Square	Black	8W	600-650	120
62-1906	5"	Square	Bronze	8W	600-650	120
62-1907	5"	Square	Brushed Nickel	8W	600-650	120
62-1914	7"	Square	White	10W	900-980	120
62-1915	7"	Square	Black	10W	850-900	120
62-1916	7"	Square	Bronze	10W	850-900	120
62-1917	7"	Square	Brushed Nickel	10W	850-900	120
62-1924	9"	Square	White	11W	1050-1100	120
62-1925	9"	Square	Black	11W	1000-1050	120
62-1926	9"	Square	Bronze	11W	1000-1050	120
62-1927	9"	Square	Brushed Nickel	11W	1000-1050	120

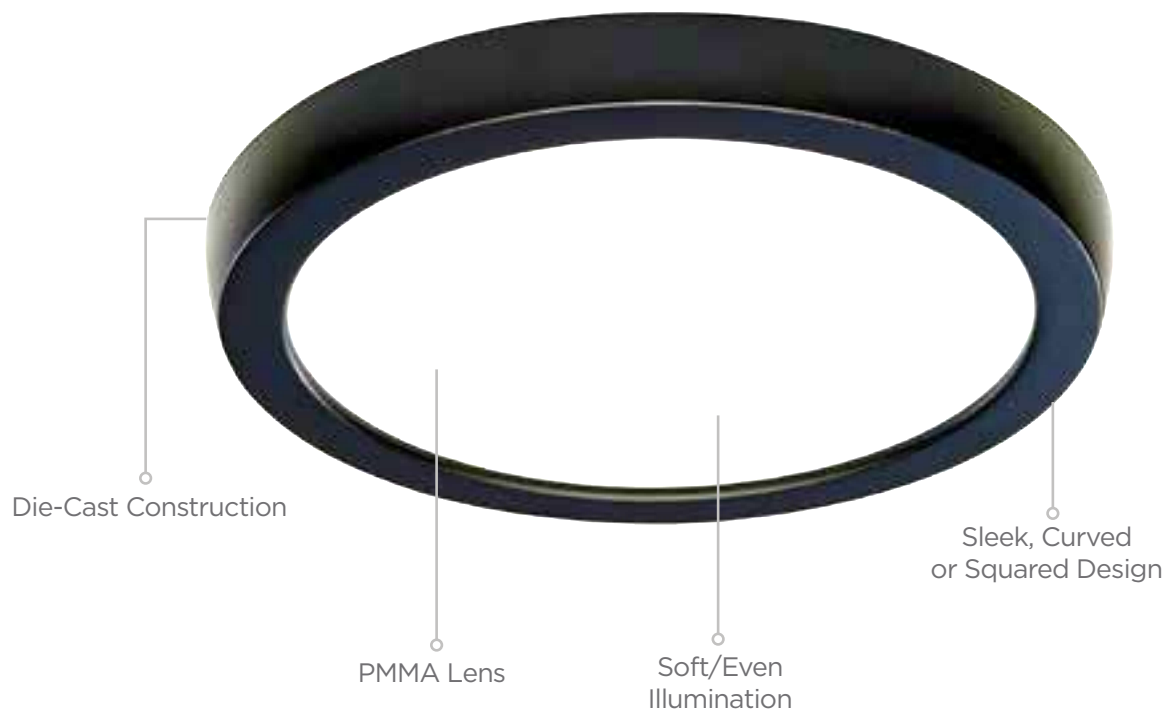

# LED GLAMOUR | FLUSH

5-CCT SELECTABLE - 2700K | 3000K | 3500K | 4000K | 5000K

ITEM	DESCRIPTION	FINISH	WATTS	VOLTS	LUMENS	DIMENSIONS
62-1875	10" Flush	Brushed Nickel	18W	120V	968-1104	D 10" x H 2.13"
62-1876	13" Flush	Brushed Nickel	25W	120V	1473-1653	D 13" x H 2.13"
62-1877	17" Flush	Brushed Nickel	25W	120V	1541-1716	D 17" x H 2.13"
62-1878	24" Flush	Brushed Nickel	39W	120V	2113-2508	D 24" x H 2.20"
62-1881	32" Flush	Brushed Nickel	50W	120V	3133-3690	D 32" x H 4.34"
62-1890	13" EM Battery Flush	Brushed Nickel	25W	120V	1286/1451/1546/1594/1496	D 13" x H 2.99"
62-1891	13" EM Battery Flush	Matte Black	25W	120V	1186/1240/1321/1353/1365	D 13" x H 2.99"
62-1975	10" Flush	Matte Black	18W	120V	968-1104	D 10" x H 2.13"
62-1976	13" Flush	Matte Black	25W	120V	1473-1653	D 13" x H 2.13"
62-1977	17" Flush	Matte Black	25W	120V	1541-1716	D 17" x H 2.13"
62-1978	24" Flush	Matte Black	39W	120V	2113-2508	D 24" x H 2.20"
62-1981	32" Flush	Matte Black	50W	120V	3133-3690	D 32" x H 4.34"

## Applications

- Kitchen
- Bathroom
- Hallway
- Office
- Utility

\* 62-1890 & 62-1891 are Non-Dimmable.



62-1981 - 32" W (shown)  
Matte Black



62-1875 - 10" W (shown)  
Brushed Nickel

## Features

- Dimmable \*
- CCT Selectable
- Long Life: 50,000 Hours
- Durable Acrylic Lens
- T24 Compliant
- cETLus Damp Location  
(62-1890 & 62-1891 are Dry Location)
- 5 Year Warranty



62-1877 - 17" W (shown)  
Brushed Nickel



62-1978 - 24" W (shown)  
Matte Black



62-1891 - 13" W (shown)  
Matte Black

### EM SPECIFICATIONS

Battery Chemistry:	LiFePO4
Battery Runtime:	90 Minutes
Battery Charging Time:	>24 Hrs.
Driver Package:	4W
Functioning Life:	50,000 Hrs.
Warranty:	5 Years

## FINISH OPTIONS



Brushed Nickel



Matte Black

# LED GLAMOUR | LINEAR

5-CCT SELECTABLE - 2700K | 3000K | 3500K | 4000K | 5000K

ITEM	DESCRIPTION	FINISH	WATTS	VOLTS	CCT	LUMENS	DIMENSIONS
62-1879	25" Linear	Brushed Nickel	25W	120V	2700K/3000K/3500K/4000K/5000K	1481-1739	L 25" x W 12" x H 4.41"
62-1880	50" Linear	Brushed Nickel	50W	120V	2700K/3000K/3500K/4000K/5000K	3192-3739	L 50" x W 12" x H 4.37"
62-1979	25" Linear	Matte Black	25W	120V	2700K/3000K/3500K/4000K/5000K	1481-1739	L 25" x W 12" x H 4.41"
62-1980	50" Linear	Matte Black	50W	120V	2700K/3000K/3500K/4000K/5000K	3192-3739	L 50" x W 12" x H 4.37"

## Applications

- Kitchen
- Bathroom
- Hallway
- Office
- Utility



62-1979 - 25" W (shown)  
Matte Black

## Features

- Dimmable
- CCT Selectable
- Long Life: 50,000 Hours
- Durable Acrylic Lens
- T24 Compliant
- cETLus Damp Location
- 5 Year Warranty



62-1640 - 50" W (shown)  
Brushed Nickel

## FINISH OPTIONS



Brushed Nickel



Matte Black

# LED GLAMOUR & CRISPO | SCONCES

5-CCT SELECTABLE - 2700K | 3000K | 3500K | 4000K | 5000K

ITEM	DESCRIPTION	FINISH	WATTS	VOLTS	CCT	LUMENS	DIMENSIONS
62-1885	9" Wall Sconce	Brushed Nickel	10W	120V	2700K/3000K/3500K/4000K/5000K	625-735	W 9" x H 10.50" x Ext. 4"
62-1985	9" Wall Sconce	Matte Black	10W	120V	2700K/3000K/3500K/4000K/5000K	625-735	W 9" x H 10.50" x Ext. 4"
62-1886	9" Wall Sconce	White	10W	120V	2700K/3000K/3500K/4000K/5000K	625-735	W 9" x H 10.50" x Ext. 4"

\*Consult Satco or visit [www.satco.com](http://www.satco.com) for an up to date dimmer compatibility list.

## Applications

- Kitchen
- Bathroom
- Hallway
- Office
- Utility

## Features

- Dimmable \*
- CCT Selectable
- Long Life: 50,000 Hours
- Durable Acrylic Lens
- Damp Location
- ADA Compliant
- T24 Compliant
- cETLus Damp Location
- 5 Year Warranty

## Glamour



62-1885 - 9" W  
Brushed Nickel



62-1985 - 9" W  
Matte Black

## Crispo



62-1886 - 9" W  
White

## FINISH OPTIONS



Brushed Nickel



Matte Black



White

# LED GLAMOUR & CRISPO | VANITIES

5-CCT SELECTABLE - 2700K | 3000K | 3500K | 4000K | 5000K

ITEM	DESCRIPTION	FINISH	WATTS	VOLTS	CCT	LUMENS	DIMENSIONS
62-1871	25" Vanity	Brushed Nickel	25W	120V	2700K/3000K/3500K/4000K/5000K	1533-1798	W 25" x H 5.71" x Ext. 3"
62-1872	49" Vanity	Brushed Nickel	50W	120V	2700K/3000K/3500K/4000K/5000K	3371-3968	W 49" x H 5.71" x Ext. 3"
62-1971	25" Vanity	Matte Black	25W	120V	2700K/3000K/3500K/4000K/5000K	1533-1798	W 25" x H 5.71" x Ext. 3"
62-1972	49" Vanity	Matte Black	50W	120V	2700K/3000K/3500K/4000K/5000K	3371-3968	W 49" x H 5.71" x Ext. 3"
62-1873	25" Vanity	White	25W	120V	2700K/3000K/3500K/4000K/5000K	1533-1798	W 25" x H 5.71" x Ext. 3"
62-1874	49" Vanity	White	50W	120V	2700K/3000K/3500K/4000K/5000K	3371-3968	W 49" x H 5.71" x Ext. 3"

## Applications

- Kitchen
- Bathroom
- Hallway
- Office
- Utility

## Features

- Dimmable \*
- CCT Selectable
- Long Life: 50,000 Hours
- Durable Acrylic Lens
- Damp Location
- ADA Compliant
- T24 Compliant
- cETLus Damp Location
- 5 Year Warranty

### Glamour



62-1971 - 25" W (shown)  
Matte Black

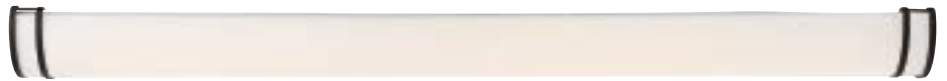

62-1972 - 49" W (shown)  
Matte Black

### Crispo



62-1873 - 25" W  
White



62-1874 - 49" W  
White

## FINISH OPTIONS



Brushed Nickel



Matte Black



White

# LED 4" SURFACE MOUNTS

STANDARD UNITS 3-CCT SELECTABLE - 3000K | 4000K | 5000K



62-1581 - 4" D (shown)  
White



62-1584 - 4" D (shown)  
Black

## Applications

- Kitchen
- Bathroom
- Hallway
- Office

## Features

- 3000K/4000K/ 5000K Models
- Dimmable
- Mounts to 4" Junction Boxes
- Wet Location
- cETLus Wet Location
- 5 Year Warranty

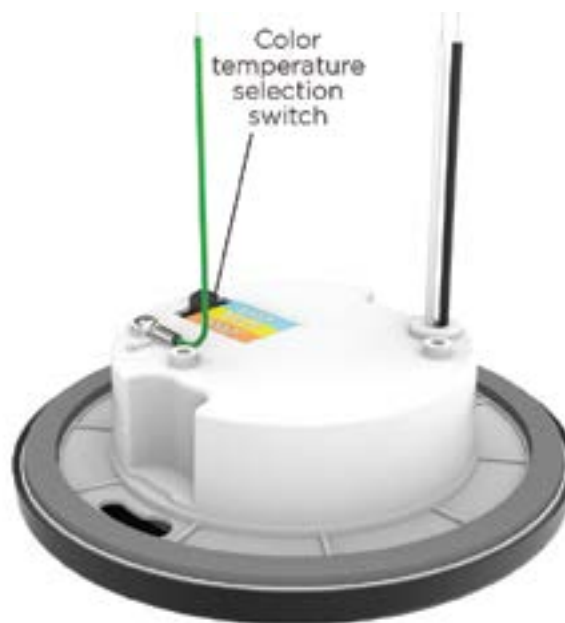

NON-CONTRACTOR PACK UNITS ONLY

## FINISH OPTIONS



White



Brushed Nickel



Bronze

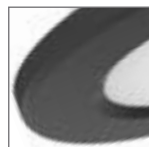

Black

ITEM	DESCRIPTION	WATTS	VOLTS	CCT	LUMENS	DIMENSIONS
62-1580	4" LED - White - Contractor 6-Pack	9W	120V	3000K	650	D 4.67"x H 1.31"
62-1590	4" LED - White - Contractor 6-Pack	9W	120V	5000K	680	D 4.67"x H 1.31"
62-1581	4" LED - White	9W	120V	3000K/4000K/5000K	680-720	D 4.67"x H 1.31"
62-1582	4" LED - Brushed Nickel	9W	120V	3000K/4000K/5000K	680-720	D 4.67"x H 1.31"
62-1583	4" LED - Bronze	9W	120V	3000K/4000K/5000K	680-720	D 4.67"x H 1.31"
62-1584	4" LED - Black	9W	120V	3000K/4000K/5000K	680-720	D 4.67"x H 1.31"

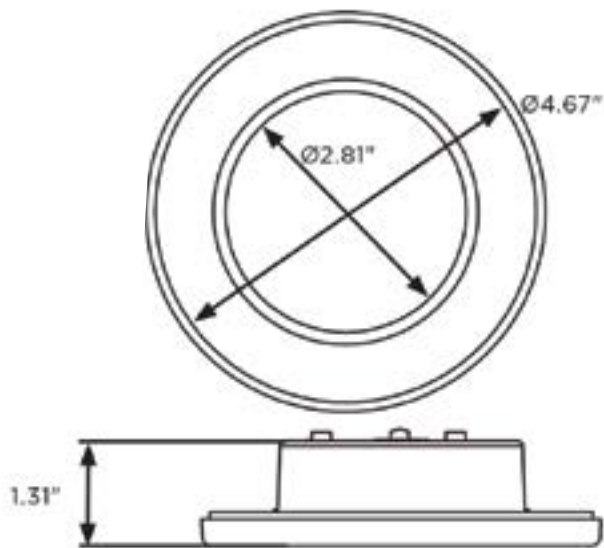

### CONTRACTOR 6-PACK UNITS



62-1580 - 4" D (shown)  
White

# LED DISK LIGHTS

5-CCT SELECTABLE - 2700K | 3000K | 3500K | 4000K | 5000K

ITEM	DESCRIPTION	WATTS	VOLTS	CCT	LUMENS	DIMENSIONS
62-1801R1	LED Disk Light 7" - Brushed Nickel	11.3W	120V	2700K/3000K/3500K/4000K/5000K	930L	D 7.40" x H 1.44"
62-1802R1	LED Disk Light 7" - Brushed Nickel	10.4W	120V	2700K/3000K/3500K/4000K/5000K	860L	D 7.40" x H 1.44"
62-1803R1	LED Disk Light 7" - Brushed Nickel	9.5W	120V	2700K/3000K/3500K/4000K/5000K	780L	D 7.40" x H 1.44"
62-1804R1	LED Disk Light 7" - Brushed Nickel	9.5W	120V	2700K/3000K/3500K/4000K/5000K	780L	D 7.40" x H 1.44"
62-1805R1	LED Disk Light 7" - Brushed Nickel	6.5W	120V	2700K/3000K/3500K/4000K/5000K	615L	D 7.40" x H 1.44"
62-1811R1	LED Disk Light 10" - Black	13.4W	120V	2700K/3000K/3500K/4000K/5000K	1100L	D 9.49" x H 1.56"
62-1812R1	LED Disk Light 10" - Black	12W	120V	2700K/3000K/3500K/4000K/5000K	1000L	D 9.49" x H 1.56"
62-1813R1	LED Disk Light 10" - Black	12W	120V	2700K/3000K/3500K/4000K/5000K	1000L	D 9.49" x H 1.56"
62-1814R1	LED Disk Light 10" - Black	12W	120V	2700K/3000K/3500K/4000K/5000K	1000L	D 9.49" x H 1.56"
62-1815R1	LED Disk Light 10" - Black	9.8W	120V	2700K/3000K/3500K/4000K/5000K	900L	D 9.49" x H 1.56"
62-1820R1	LED Disk Light 7" w/OCC - White	10.9W	120V	2700K/3000K/3500K/4000K/5000K	900L	D 7.40" x H 1.56"
62-1821R1	LED Disk Light 10" w/OCC - White	12.6W	120V	2700K/3000K/3500K/4000K/5000K	1060L	D 9.80" x H 1.72"

62-1805R1 & 62-1815R1 Complies with NEC 410.16(A)(3) & NEC 410.16(C)(5)

## Applications

- Kitchen
- Bathroom
- Hallway
- Office
- Closets



62-1802R1 - 7" D (shown)  
Brushed Nickel



LED Module - 7"

## Features

- Dimmable
- Long Life: 50,000 Hours
- Durable Acrylic Lens
- T24 Compliant
- cETLus Wet Location
- 5 Year Warranty



62-1814R1 - 10" D (shown)  
Black



LED Module - 10"

## FINISH OPTIONS



White



Brushed Nickel

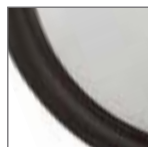

Bronze



Black



62-1820R1 - 10" D (shown)

Various Sizes  
Available

# LED CLOUD FIXTURES

5-CCT SELECTABLE - 2700K | 3000K | 3500K | 4000K | 5000K

ITEM	DESCRIPTION	WATTS	VOLTS	CCT	MAX LUMENS	DIMENSIONS
62-1850	11" Cloud LED CCT Select.	12.5W	120V	2700K/3000K/3500K/4000K/5000K	1180	D 11" x H 3.13"
62-1851	11" Cloud LED CCT Select. w/ Sensor	11.5W	120V	2700K/3000K/3500K/4000K/5000K	1180	D 11" x H 3.15"
62-1852	14" Cloud LED CCT Selectable	15W	120V	2700K/3000K/3500K/4000K/5000K	1440	D 13.98" x H 3.17"
62-1853	14" Cloud LED CCT Select. w/ Sensor	17W	120V	2700K/3000K/3500K/4000K/5000K	1440	D 13.98" x H 3.17"
62-1854	11" Square Cloud LED CCT Select.	11W	120V	2700K/3000K/3500K/4000K/5000K	1180	L 11.02" x W 11.02" x H 3.15"
62-1855	11" Square Cloud LED CCT Select. w/ Sensor	11.5	120V	2700K/3000K/3500K/4000K/5000K	1180	L 11.02" x W 11.02" x H 3.15"
62-1856	14" Square Cloud LED CCT Select.	17W	120V	2700K/3000K/3500K/4000K/5000K	1440	L 13.39" x W 13.39" x H 3.19"
62-1857	14" Square Cloud LED CCT Select. w/ Sensor	17W	120V	2700K/3000K/3500K/4000K/5000K	1440	L 13.39" x W 13.39" x H 3.19"
62-1858	19" Cloud LED CCT Select.	25W	120V	2700K/3000K/3500K/4000K/5000K	2732	D 18.90" x H 4.13"
62-1859	19" Cloud LED CCT Select. w/ Sensor	25W	120V	2700K/3000K/3500K/4000K/5000K	2732	D 18.90" x H 4.13"
62-1860	11" Cloud LED CCT Select.	14W	120-277V	2700K/3000K/3500K/4000K/5000K	1250	D 11.02" x H 3.11"
62-1861	14" Cloud LED CCT Select. w/ Sensor	17W	120-277V	2700K/3000K/3500K/4000K/5000K	1600	D 13.98" x H 3.15"

Microwave Sensor Minimum Room Size: 50 Square Feet

Complies with NEC 410.16 (A)(3) and NEC 410.16 (C)(5)

62-1861 is Not For Use in Closets

## Applications

- Kitchen
- Bathroom
- Hallway
- Closets
- Office

## Features

- Available With / Without Occupancy Sensor
- Dimmable (without sensor only)
- 90 CRI
- Long Life: 50,000 Hours
- Polymethyl Methacrylate (PMMA)
- cETLus Damp Location
- 5 Year Warranty



62-1850 - 11" D  
Various Sizes Available



62-1854 - 11" W  
Various Sizes Available

## FINISH



White

# LED WRAP FIXTURES

5-CCT SELECTABLE - 2700K | 3000K | 3500K | 4000K | 5000K

ITEM	DESCRIPTION	WATTS	VOLTS	FINISH	MAX LUMENS	CRI	DIMENSIONS
65-1210	LED 2 Foot Wrap	20W	120-277V	White	1200	90	L 24.33" x W 5.50" x H 2.56"
65-1211	LED 4 Foot Wrap	39W	120-277V	White	2500	90	L 47.24" x W 5.50" x H 2.56"
65-1212	LED 2 Foot Wrap w/ Pull Chain	20W	120V	White	1000	90	L 24.77" x W 5.50" x H 2.56"
65-1213	LED 4 Foot Wrap w/ Pull Chain	39W	120V	White	2000	90	L 47.68" x W 5.50" x H 2.56"
65-1214	LED 2 Foot Wrap w/ PIR Motion Sensor	20W	120-277V	White	3100	90	L 24.33" x W 5.50" x H 2.56"
65-1215	LED 4 Foot Wrap w/ PIR Motion Sensor	39W	120-277V	White	3100	90	L 47.24" x W 5.50" x H 2.56"

## Applications

- Kitchen
- Utility Rooms
- Hallway
- Office
- Closets



65-1211 - 47" L (shown)

## Features

- CCT Selectable
- Durable Acrylic Lens
- Available With / Without On/Off Pull Chain or PIR Sensor
- Damp Location
- Complies with NEC 410.16(A)(3) & NEC 410.16(C)(5)
- cETLus Damp Location
- Long Life: 50,000 Hours
- 5 Year Warranty



65-1213 - 48" L (shown)



65-1215 - 47" L (shown)

## FINISH



White



CCT Switch



Pull Chain



PIR Motion Sensor

# LED 18" WRAP W/ DUAL GFCI

5-CCT SELECTABLE - 2700K | 3000K | 3500K | 4000K | 5000K

ITEM	DESCRIPTION	WATTS	VOLTS	FINISH	LUMENS	CRI	DIMENSIONS
62-700	LED 18" Wrap	14W	120-277V	White	1298-1391	90	L 18" x W 4.40" x EXT. 2.50"

ADA Compliant

## Applications

- Kitchen
- Bathroom
- Hallway
- Office

## Features

- Easy to read LED Status Light
- Built-in Surge Protection
- White Finish & White Lens
- Dual GFCI Outlets
- cETLus Damp Location
- Long Life: 50,000 Hours
- 5 Year Warranty



62-700 - 18" L



5 CCT Selectable Switch



GFCI Status LED:  
 Green LED = Normal  
 Red LED = Alert  
 No LED = No Power

Dual Tamper Resistant GFCI Outlet: 15 Amp Circuit with 14 Gauge Wire.

Protection Against Electric Shock

## FINISH



White

# LED STRIP FIXTURES

5-CCT SELECTABLE - 2700K | 3000K | 3500K | 4000K | 5000K

ITEM	DESCRIPTION	WATTS	VOLTS	FINISH	MAX LUMENS	CRI	DIMENSIONS
65-1220	LED 2 Foot Strip Light	10W	120-277V	White	1200	90	L 22.71" x W 1.46" x H 1.88"
65-1221	LED 4 Foot Strip Light	19W	120-277V	White	2500	90	L 46.41" x W 1.46" x H 1.88"
65-1222	LED 1 Foot Connectable Strip Light	10W	120V	White	1000	90	L 12.13" x W 1.56" x H 1.72"
65-1223	LED 2 Foot Connectable Strip Light	20W	120V	White	2000	90	L 22.75" x W 1.56" x H 1.72"
65-1224	LED 4 Foot Connectable Strip Light	30	120	White	3100	90	L 46.50" x W 1.56" x H 1.72"

\*65-1223 & 65-1224 Complies with NEC 410.16(A)(3) & NEC 410.16(C)(5)

## Applications

- Kitchen
- Utility Rooms
- Hallway
- Office
- Closets\*



## Features

- CCT Selectable
- Connectable Models are Hard-Wire or Plug-in
- Long Life: 50,000 Hours
- Durable Acrylic Lens
- cETLus Damp Location
- 5 Year Warranty



## AVAILABLE ACCESSORIES

ITEM	SIZE / DESCRIPTION	COMPATIBILITY
65-1225	5' Power Cord	65-1222, 65-1223, 65-1224
65-1226	8" Male/Male Joiner	65-1222, 65-1223, 65-1224
65-1227	16" Male/Male Joiner	65-1222, 65-1223, 65-1224
65-1228	24" Male/Male Joiner	65-1222, 65-1223, 65-1224

Male to Male Flush Connector Included with Fixture



65-1225



65-1226



65-1227



65-1228

## FINISH



White



CCT Switch

# LED TWIST & LOCK

## 12" & 14" FLUSH MOUNTS

ITEM	DESCRIPTION	WATTS	VOLTS	CCT	LUMENS	DIMENSIONS
62-686	LED 12" 18W Twist & Lock Fixture - Brushed Nickel	18W	120V/277V	3000K	1500L	D 11.75" x H 4.5"
62-687	LED 12" 18W Twist & Lock Fixture - Matte Black	18W	120V/277V	3000K	1500L	D 11.75" x H 4.5"
62-688	LED 14" 25W Twist & Lock Fixture - Brushed Nickel	25W	120V/277V	3000K	2100L	D 14.00" x H 5.5"
62-689	LED 14" 25W Twist & Lock Fixture - Matte Black	25W	120V/277V	3000K	2100L	D 14.00" x H 5.5"

### Applications

- Kitchen
- Bathroom
- Hallway
- Office

### Features

- Dimmable
- 90CRI
- Twist & Lock Frosted Glass Lens
- Long Life: 50,000 Hours
- cETLus Damp Location
- 5 Year Warranty



62-686 - 12" D (shown)



62-688 - 14" D (shown)

### FINISH OPTIONS



Matte Black



Brushed Nickel



# TRACK lighting

## LIKE A FINE WINE

These brilliant lighting concepts just get better with age. After more than six decades in use, track lighting remains one of the most versatile lighting solutions. Advanced LED technology is showcased in our color selectable and beam adjustable products. Featured here are new compact sizes which deliver discrete source of light and “Starfish Smart” options offer a new level of control and flexibility.



# LED TRACK HEADS

ITEM	DESCRIPTION	FINISH	WATTS	LENGTH	WIDTH	HEIGHT	EXT.	CCT	LUMENS	CRI	CERT. TYPE
TH903	LED Track Head; Starfish Enabled	Matte White	12	2.25"	5.38"	5.38"	6.38"	2000K-5000K	1100	80	Dry
TH904	LED Track Head; Starfish Enabled	Matte Black	12	2.25"	5.38"	5.38"	6.38"	2000K-5000K	1100	80	Dry
TH913	LED Track Head; Starfish Enabled	Matte White	12	2.83"	5.91"	3.63"	5.63"	2000K-5000K	1100	80	Dry
TH914	LED Track Head; Starfish Enabled	Matte Black	12	2.83"	5.91"	3.63"	5.63"	2000K-5000K	1100	80	Dry



Lumens measured at LED source

3 Conductor "H" type system

Beam Angles: TH903, TH904 - 24° | TH913, TH914 - 36°



TH903 - 5" W (shown)  
Matte White



TH914 - 6" W (shown)  
Matte Black



STARFISH®

Controlled with App



Dynamic RGB  
Color-Changing  
& Tunable White



Millions of Colors

Warm to Cool Tunable White

## FINISH OPTIONS



Matte Black



Matte White

STARFISH



TH904 Shown



For Use with H-Type Track

# LED MONOPOINTS

ITEM	DESCRIPTION	FINISH	LIGHT SOURCE	WATTS	LENGTH	WIDTH	HEIGHT	EXT.	CCT	LUMENS	CRI	CERT. TYPE
62-1105	LED Barrel; Monopoint	Black	LED	12	3"	4.75"	2.25"	4.75"	3000K	1020	90	Dry
62-1106	LED Barrel; Monopoint	White	LED	12	3"	4.75"	2.25"	4.75"	3000K	1020	90	Dry
62-1107	LED Taper Back; Monopoint	Black	LED	12	2.75"	4.75"	2.25"	4.75"	3000K	1020	90	Dry
62-1108	LED Taper Back; Monopoint	White	LED	12	2.75"	4.75"	2.25"	4.75"	3000K	1020	90	Dry



Lumens measured at LED source  
 3 Conductor "H" type system  
 36° Beam angles



62-1106 - 5" W (shown)  
 White



62-1107 - 5" W (shown)  
 Black

## FINISH OPTIONS



White



Black

# LED TRACK HEADS

## ANGLE ARM

ITEM	DESCRIPTION	FINISH	LIGHT SOURCE	WATTS	LENGTH	WIDTH	HEIGHT	EXT.	CCT	LUMENS	CRI	CERT. TYPE
TH421	LED Track Head; 24°	White	LED	12	3.38"	2.75"	2.75"	5.75"	3000K	1020	90	Dry
TH422	LED Track Head; 24°	Black	LED	12	3.38"	2.75"	2.75"	5.75"	3000K	1020	90	Dry
TH423	LED Track Head; 36°	White	LED	12	3.38"	2.75"	2.75"	5.75"	3000K	1020	90	Dry
TH424	LED Track Head; 36°	Black	LED	12	3.38"	2.75"	2.75"	5.75"	3000K	1020	90	Dry
TH425	LED Track Head; 24°	Brushed Nickel	LED	12	3.38"	2.75"	2.75"	5.75"	3000K	1020	90	Dry
TH427	LED Track Head; 36°	Brushed Nickel	LED	12	3.38"	2.75"	2.75"	5.75"	3000K	1020	90	Dry



Lumens measured at LED source  
3 Conductor "H" type system



TH421 - 3" W (shown)  
White



TH422 - 3" W (shown)  
Black



TH425 - 3" W (shown)  
Brushed Nickel

### FINISH OPTIONS



White



Black



Brushed Nickel



For Use with H-Type Track

# LED TRACK HEADS

BARREL

ITEM	DESCRIPTION	FINISH	LIGHT SOURCE	WATTS	LENGTH	WIDTH	HEIGHT	EXT.	CCT	LUMENS	CRI	CERT. TYPE
TH431	LED Track Head; 24°	White	LED	12	3.75"	2.25"	2.25"	5.75"	3000K	1020	90	Dry
TH432	LED Track Head; 24°	Black	LED	12	3.75"	2.25"	2.25"	5.75"	3000K	1020	90	Dry
TH433	LED Track Head; 36°	White	LED	12	3.75"	2.25"	2.25"	5.75"	3000K	1020	90	Dry
TH434	LED Track Head; 36°	Black	LED	12	3.75"	2.25"	2.25"	5.75"	3000K	1020	90	Dry
TH435	LED Track Head; 24°	Brushed Nickel	LED	12	3.75"	2.25"	2.25"	5.75"	3000K	1020	90	Dry
TH437	LED Track Head; 36°	Brushed Nickel	LED	12	3.75"	2.25"	2.25"	5.75"	3000K	1020	90	Dry

Lumens measured at LED source

3 Conductor "H" type system



TH431 - 2" W (shown)  
White



TH432 - 2" W (shown)  
Black



TH435 - 2" W (shown)  
Brushed Nickel

## FINISH OPTIONS



White



Black



Brushed Nickel



For Use with H-Type Track

## SMALL CYLINDER

ITEM	DESCRIPTION	FINISH	WATTS	LENGTH	WIDTH	HEIGHT	EXT.	CCT	LUMENS	CRI	CERT. TYPE
TH471	LED Track Head; 24°	Matte White	12	3.38"	2.25"	2.25"	5.38"	3000K	1020	90	Dry
TH472	LED Track Head; 24°	Matte Black	12	3.38"	2.25"	2.25"	5.38"	3000K	1020	90	Dry
TH473	LED Track Head; 36°	Matte White	12	3.38"	2.25"	2.25"	5.38"	3000K	1020	90	Dry
TH474	LED Track Head; 36°	Matte Black	12	3.38"	2.25"	2.25"	5.38"	3000K	1020	90	Dry
TH475	LED Track Head; 24°	Brushed Nickel	12	3.38"	2.25"	2.25"	5.38"	3000K	1020	90	Dry
TH477	LED Track Head; 36°	Brushed Nickel	12	3.38"	2.25"	2.25"	5.38"	3000K	1020	90	Dry
TH637	LED Track Head; 24°	Matte Black / Brushed Brass	12	3.38"	2.25"	2.25"	5.38"	3000K	1020	90	Dry
TH638	LED Track Head; 24°	Matte Black / Brushed Nickel	12	3.38"	2.25"	2.25"	5.38"	3000K	1020	90	Dry
TH647	LED Track Head; 36°	Matte Black / Brushed Brass	12	3.38"	2.25"	2.25"	5.38"	3000K	1020	90	Dry
TH648	LED Track Head; 36°	Matte Black / Brushed Nickel	12	3.38"	2.25"	2.25"	5.38"	3000K	1020	90	Dry



Lumens measured at LED source  
3 Conductor "H" type system



TH475 - 4" L (shown)  
Brushed Nickel



TH473 - 4" L (shown)  
Matte Black



TH471 - 4" L (shown)  
Matte White



TH637 - 3" L (shown)  
Matte Black w/  
Brushed Brass



TH638 - 3" L (shown)  
Matte Black w/  
Brushed Nickel

### FINISH OPTIONS



Matte White



Matte Black



Brushed Nickel



Matte Black w/  
Brushed Brass



Matte Black w/  
Brushed Nickel



For Use with H-  
Type Track

# LED TRACK HEADS

PIPE

ITEM	DESCRIPTION	FINISH	LIGHT SOURCE	WATTS	LENGTH	WIDTH	HEIGHT	EXT.	CCT	LUMENS	CRI	CERT. TYPE
<b>Pipe</b>												
TH441	LED Track Head; 24°	White	LED	12	3.38"	2.38"	2.38"	6.25"	3000K	1020	90	Dry
TH442	LED Track Head; 24°	Black	LED	12	3.38"	2.38"	2.38"	6.25"	3000K	1020	90	Dry
TH443	LED Track Head; 36°	White	LED	12	3.38"	2.38"	2.38"	6.25"	3000K	1020	90	Dry
TH444	LED Track Head; 36°	Black	LED	12	3.38"	2.38"	2.38"	6.25"	3000K	1020	90	Dry
TH445	LED Track Head; 24°	Brushed Nickel	LED	12	3.38"	2.38"	2.38"	6.25"	3000K	1020	90	Dry
TH447	LED Track Head; 36°	Brushed Nickel	LED	12	3.38"	2.38"	2.38"	6.25"	3000K	1020	90	Dry
<b>Dual Pipe</b>												
TH480	LED Track Head; 24°	Black	LED	24	2.38"	6.75"	2.38"	6"	3000K	2040	90	Dry
TH481	LED Track Head; 36°	Black	LED	24	2.38"	6.75"	2.38"	6"	3000K	2040	90	Dry
TH482	LED Track Head; 24°	White	LED	24	2.38"	6.75"	2.38"	6"	3000K	2040	90	Dry
TH483	LED Track Head; 36°	White	LED	24	2.38"	6.75"	2.38"	6"	3000K	2040	90	Dry



Lumens measured at LED source  
3 Conductor "H" type system



TH441 - 2" W (shown)  
White



TH442 - 2" W (shown)  
Black



TH445 - 2" W (shown)  
Brushed Nickel



TH480 - 7" W (shown)  
Black



TH482 - 7" W (shown)  
White

## FINISH OPTIONS



White



Black



Brushed Nickel



For Use with H-Type Track

# SQUARE

ITEM	DESCRIPTION	FINISH	LIGHT SOURCE	WATTS	LENGTH	WIDTH	HEIGHT	EXT.	CCT	LUMENS	CRI	CERT. TYPE
<b>Square</b>												
TH461	LED Track Head; 24°	White	LED	12	2.38"	2.75"	2.25"	5.5"	3000K	1020	90	Dry
TH462	LED Track Head; 24°	Black	LED	12	2.38"	2.75"	2.25"	5.5"	3000K	1020	90	Dry
TH463	LED Track Head; 36°	White	LED	12	2.38"	2.75"	2.25"	5.5"	3000K	1020	90	Dry
TH464	LED Track Head; 36°	Black	LED	12	2.38"	2.75"	2.25"	5.5"	3000K	1020	90	Dry
TH465	LED Track Head; 24°	Brushed Nickel	LED	12	2.38"	2.75"	2.25"	5.5"	3000K	1020	90	Dry
TH467	LED Track Head; 36°	Brushed Nickel	LED	12	2.38"	2.75"	2.25"	5.5"	3000K	1020	90	Dry
<b>Dual Square</b>												
TH484	LED Track Head; 24°	Black	LED	24	2.38"	6.75"	2.38"	6.5"	3000K	2040	90	Dry
TH485	LED Track Head; 36°	Black	LED	24	2.38"	6.75"	2.38"	6.5"	3000K	2040	90	Dry
TH486	LED Track Head; 24°	White	LED	24	2.38"	6.75"	2.38"	6.5"	3000K	2040	90	Dry
TH487	LED Track Head; 36°	White	LED	24	2.38"	6.75"	2.38"	6.5"	3000K	2040	90	Dry



Lumens measured at LED source  
3 Conductor "H" type system



TH461 - 3" W (shown)  
White



TH462 - 3" W (shown)  
Black



TH465 - 3" W (shown)  
Brushed Nickel



TH486 - 7" W (shown)  
White



TH484 - 7" W (shown)  
Black

## FINISH OPTIONS



White



Black



Brushed Nickel



For Use with H-Type Track

# LED TRACK HEADS

ROUND

ITEM	DESCRIPTION	FINISH	LIGHT SOURCE	WATTS	LENGTH	WIDTH	HEIGHT	EXT.	CCT	LUMENS	CRI	CERT. TYPE
TH401	LED Track Head; 24°	White	LED	12	2.25"	3.25"	3.25"	6.25"	3000K	1020	90	Dry
TH402	LED Track Head; 24°	Black	LED	12	2.25"	3.25"	3.25"	6.25"	3000K	1020	90	Dry
TH403	LED Track Head; 36°	White	LED	12	2.25"	3.25"	3.25"	6.25"	3000K	1020	90	Dry
TH404	LED Track Head; 36°	Black	LED	12	2.25"	3.25"	3.25"	6.25"	3000K	1020	90	Dry
TH405	LED Track Head; 24°	Brushed Nickel	LED	12	2.25"	3.25"	3.25"	6.25"	3000K	1020	90	Dry
TH407	LED Track Head; 36°	Brushed Nickel	LED	12	2.25"	3.25"	3.25"	6.25"	3000K	1020	90	Dry
TH635	LED Track Head; 24°	Matte Black / Brushed Brass	LED	12	2.25"	3.25"	3.25"	6.25"	3000K	1020	90	Dry
TH636	LED Track Head; 24°	Matte Black / Brushed Nickel	LED	12	2.25"	3.25"	3.25"	6.25"	3000K	1020	90	Dry
TH645	LED Track Head; 36°	Matte Black / Brushed Brass	LED	12	2.25"	3.25"	3.25"	6.25"	3000K	1020	90	Dry
TH646	LED Track Head; 36°	Matte Black / Brushed Nickel	LED	12	2.25"	3.25"	3.25"	6.25"	3000K	1020	90	Dry



Lumens measured at LED source  
3 Conductor "H" type system



TH405 - 3" W (shown)  
Brushed Nickel



TH401 - 3" W (shown)  
White



TH402 - 3" W (shown)  
Black



TH636 - 3" W (shown)  
Matte Black w/  
Brushed Nickel



TH635 - 3" W (shown)  
Matte Black w/  
Brushed Brass

## FINISH OPTIONS



White



Black



Brushed Nickel



Matte Black w/  
Brushed Brass



Matte Black w/  
Brushed Nickel



For Use with H-  
Type Track

ITEM	DESCRIPTION	FINISH	LIGHT SOURCE	WATTS	LENGTH	WIDTH	HEIGHT	EXT.	CCT	LUMENS	CRI	CERT. TYPE
TH601	LED Commercial Track Head; 24°	White	LED	10	5"	2"	2"	7.38"	3000K	600	93	Dry
TH602	LED Commercial Track Head; 24°	Black	LED	10	5"	2"	2"	7.38"	3000K	600	93	Dry
TH603	LED Commercial Track Head; 36°	White	LED	10	5"	2"	2"	7.38"	3000K	600	93	Dry
TH604	LED Commercial Track Head; 36°	Black	LED	10	5"	2"	2"	7.38"	3000K	600	93	Dry
TH611	LED Commercial Track Head; 24°	White	LED	20	6.13"	2.5"	2.5"	8.5"	3000K	1200	93	Dry
TH612	LED Commercial Track Head; 24°	Black	LED	20	6.13"	2.5"	2.5"	8.5"	3000K	1200	93	Dry
TH613	LED Commercial Track Head; 36°	White	LED	20	6.13"	2.5"	2.5"	8.5"	3000K	1200	93	Dry
TH614	LED Commercial Track Head; 36°	Black	LED	20	6.13"	2.5"	2.5"	8.5"	3000K	1200	93	Dry
TH621	LED Commercial Track Head; 24°	White	LED	30	7.13"	3.125"	3.13"	9.25"	3000K	2000	93	Dry
TH622	LED Commercial Track Head; 24°	Black	LED	30	7.13"	3.125"	3.13"	9.25"	3000K	2000	93	Dry
TH623	LED Commercial Track Head; 36°	White	LED	30	7.13"	3.125"	3.13"	9.25"	3000K	2000	93	Dry
TH624	LED Commercial Track Head; 36°	Black	LED	30	7.13"	3.125"	3.13"	9.25"	3000K	2000	93	Dry



Lumens measured at LED source  
3 Conductor "H" type system



TH601 - 5" L (shown)  
White



TH612 - 6" L (shown)  
Black



TH623 - 7" L (shown)  
White

FINISH OPTIONS



White

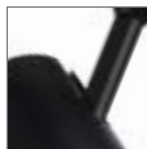

Black



For Use with H-Type Track

# LED TRACK HEADS

PINCH BACK

ITEM	DESCRIPTION	FINISH	LIGHT SOURCE	WATTS	LENGTH	WIDTH	HEIGHT	EXT.	CCT	LUMENS	CRI	CERT. TYPE
TH411	LED Track Head; 24°	White	LED	12	3.63"	2.88"	2.88"	5.5"	3000K	1020	90	Dry
TH412	LED Track Head; 24°	Black	LED	12	3.63"	2.88"	2.88"	5.5"	3000K	1020	90	Dry
TH413	LED Track Head; 36°	White	LED	12	3.63"	2.88"	2.88"	5.5"	3000K	1020	90	Dry
TH414	LED Track Head; 36°	Black	LED	12	3.63"	2.88"	2.88"	5.5"	3000K	1020	90	Dry
TH415	LED Track Head; 24°	Brushed Nickel	LED	12	3.63"	2.88"	2.88"	5.5"	3000K	1020	90	Dry
TH417	LED Track Head; 36°	Brushed Nickel	LED	12	3.63"	2.88"	2.88"	5.5"	3000K	1020	90	Dry



Lumens measured at LED source  
3 Conductor "H" type system



TH411 - 3" W (shown)  
White



TH412- 3" W (shown)  
Black



TH415 - 3" W (shown)  
Brushed Nickel

## FINISH OPTIONS



White



Black



Brushed Nickel



For Use with H-  
Type Track

## TAPER BACK

ITEM	DESCRIPTION	FINISH	LIGHT SOURCE	WATTS	LENGTH	WIDTH	HEIGHT	EXT.	CCT	LUMENS	CRI	CERT. TYPE
TH451	LED Track Head; 24°	White	LED	12	2.75"	2.88"	2.88"	5.75"	3000K	1020	90	Dry
TH452	LED Track Head; 24°	Black	LED	12	2.75"	2.88"	2.88"	5.75"	3000K	1020	90	Dry
TH453	LED Track Head; 36°	White	LED	12	2.75"	2.88"	2.88"	5.75"	3000K	1020	90	Dry
TH454	LED Track Head; 36°	Black	LED	12	2.75"	2.88"	2.88"	5.75"	3000K	1020	90	Dry
TH455	LED Track Head; 24°	Brushed Nickel	LED	12	2.75"	2.88"	2.88"	5.75"	3000K	1020	90	Dry
TH457	LED Track Head; 36°	Brushed Nickel	LED	12	2.75"	2.88"	2.88"	5.75"	3000K	1020	90	Dry



Lumens measured at LED source  
3 Conductor "H" type system



TH452 - 3" W (shown)  
Black



TH453 - 3" W (shown)  
White



TH455 - 3" W (shown)  
Brushed Nickel

### FINISH OPTIONS



White



Black



Brushed Nickel



For Use with H-Type Track

# LED TRACK HEADS

FORGED

ITEM	DESCRIPTION	FINISH	LIGHT SOURCE	WATTS	LENGTH	WIDTH	HEIGHT	EXT.	CCT	LUMENS	CRI	CERT. TYPE
TH488	LED Track Head; 24°	Black	LED	12	3"	2.75"	2.75"	6.25"	3000K	1020	90	Dry
TH489	LED Track Head; 24°	Black	LED	12	3"	2.75"	2.75"	6.25"	3000K	1020	90	Dry
TH490	LED Track Head; 36°	White	LED	12	3"	2.75"	2.75"	6.25"	3000K	1020	90	Dry
TH491	LED Track Head; 36°	White	LED	12	3"	2.75"	2.75"	6.25"	3000K	1020	90	Dry
TH492	LED Track Head; 24°	Brushed Nickel	LED	12	3"	2.75"	2.75"	6.25"	3000K	1020	90	Dry
TH493	LED Track Head; 36°	Brushed Nickel	LED	12	3"	2.75"	2.75"	6.25"	3000K	1020	90	Dry



Lumens measured at LED source  
3 Conductor "H" type system



TH488 - 3" W (shown)  
Black



TH490 - 3" W (shown)  
White



TH492 - 3" W (shown)  
Brushed Nickel

## FINISH OPTIONS



White



Black



Brushed Nickel



For Use with H-Type Track

ITEM	DESCRIPTION	FINISH	LIGHT SOURCE	WATTS	LENGTH	WIDTH	HEIGHT	EXT.	CCT	LUMENS	CRI	CERT. TYPE
TH631	LED Track Head; 24°	Matte Black	LED	12	3.88"	3.25"	3.25"	5.25"	3000K	1020	90	Dry
TH632	LED Track Head; 24°	Matte White	LED	12	3.88"	3.25"	3.25"	5.25"	3000K	1020	90	Dry
TH633	LED Track Head; 24°	Matte Black / Brushed Brass	LED	12	3.88"	3.25"	3.25"	5.25"	3000K	1020	90	Dry
TH634	LED Track Head; 24°	Matte Black / Brushed Nickel	LED	12	3.88"	3.25"	3.25"	5.25"	3000K	1020	90	Dry
TH641	LED Track Head; 36°	Matte Black	LED	12	3.88"	3.25"	3.25"	5.25"	3000K	1020	90	Dry
TH642	LED Track Head; 36°	Matte White	LED	12	3.88"	3.25"	3.25"	5.25"	3000K	1020	90	Dry
TH643	LED Track Head; 36°	Matte Black w/ Brushed Brass	LED	12	3.88"	3.25"	3.25"	5.25"	3000K	1020	90	Dry
TH644	LED Track Head; 36°	Matte Black w/ Brushed Nickel	LED	12	3.88"	3.25"	3.25"	5.25"	3000K	1020	90	Dry



Lumens measured at LED source  
3 Conductor "H" type system



TH631 - 3" W (shown)  
Matte Black



TH632 - 3" W (shown)  
Matte White



TH634 - 3" W (shown)  
Matte Black w/  
Brushed Nickel



TH633 - 3" W (shown)  
Matte Black w/  
Brushed Brass

FINISH OPTIONS



Matte White

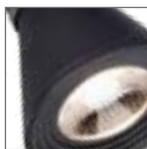

Matte Black

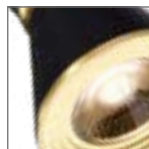

Matte Black w/  
Brushed Brass



Matte Black w/  
Brushed Nickel



For Use with H-  
Type Track

# LED TRACK HEADS

## LANTERN

ITEM	DESCRIPTION	FINISH	WATTS	LENGTH	WIDTH	HEIGHT	EXT.	CCT	LUMENS	CRI	CERT. TYPE
TH651	LED Track Head; 24°	; White	12	2.75"	2.75"	3"	6"	3000K	1020	90	Dry
TH652	LED Track Head; 24°	Black	12	2.75"	2.75"	3"	6"	3000K	1020	90	Dry
TH653	LED Track Head; 24°	Brushed Nickel	12	2.75"	2.75"	3"	6"	3000K	1020	90	Dry
TH661	LED Track Head; 36°	White	12	2.75"	2.75"	3"	6"	3000K	1020	90	Dry
TH662	LED Track Head; 36°	Black	12	2.75"	2.75"	3"	6"	3000K	1020	90	Dry
TH663	LED Track Head; 36°	Brushed Nickel	12	2.75"	2.75"	3"	6"	3000K	1020	90	Dry



Lumens measured at LED source  
3 Conductor "H" type system



TH651 - 3" W (shown)  
White



TH652 - 3" W (shown)  
Black



TH653 - 3" W (shown)  
Brushed Nickel

### FINISH OPTIONS



White



Black



Brushed Nickel



For Use with H-Type Track

# PISTON

ITEM	DESCRIPTION	FINISH	LIGHT SOURCE	WATTS	LENGTH	WIDTH	HEIGHT	EXT.	CCT	LUMENS	CRI	CERT. TYPE
TH494	LED Track Head; 24°	Black	LED	12	2.75"	2.75"	2.75"	5.75"	3000K	1020	90	Dry
TH495	LED Track Head; 36°	Black	LED	12	2.75"	2.75"	2.75"	5.75"	3000K	1020	90	Dry
TH496	LED Track Head; 24°	White	LED	12	2.75"	2.75"	2.75"	5.75"	3000K	1020	90	Dry
TH497	LED Track Head; 36°	White	LED	12	2.75"	2.75"	2.75"	5.75"	3000K	1020	90	Dry
TH498	LED Track Head; 24°	Brushed Nickel	LED	12	2.75"	2.75"	2.75"	5.75"	3000K	1020	90	Dry
TH499	LED Track Head; 36°	Brushed Nickel	LED	12	2.75"	2.75"	2.75"	5.75"	3000K	1020	90	Dry



Lumens measured at LED source  
3 Conductor "H" type system



TH494 - 3" W (shown)  
Black



TH496 - 3" W (shown)  
White



TH498 - 3" W (shown)  
Brushed Nickel

## FINISH OPTIONS



White



Black



Brushed Nickel



For Use with H-Type Track

# LED TRACK HEADS

H-STYLE

5-CCT SELECTABLE - 2700K | 3000K | 3500K | 4000K | 5000K

ITEM	DESCRIPTION	FINISH	WATTS	LENGTH	WIDTH	HEIGHT	EXT.	LUMENS	CRI	CERT. TYPE
<b>H-Type</b>										
TH701	LED Track Head; 36°	Matte White	10	5"	2"	5.38"	7.75"	700	90	Dry
TH702	LED Track Head; 36°	Matte Black	10	5"	2"	5.38"	7.75"	700	90	Dry
TH703	LED Track Head; 48°	Matte White	10	5"	2"	5.38"	7.75"	700	90	Dry
TH704	LED Track Head; 48°	Matte Black	10	5"	2"	5.38"	7.75"	700	90	Dry
TH711	LED Track Head; 36°	Matte White	20	6.31"	2.43"	5.88"	8.63"	1400	90	Dry
TH712	LED Track Head; 36°	Matte Black	20	6.31"	2.43"	5.88"	8.63"	1400	90	Dry
TH713	LED Track Head; 48°	Matte White	20	6.31"	2.43"	5.88"	8.63"	1400	90	Dry
TH714	LED Track Head; 48°	Matte Black	20	6.31"	2.43"	5.88"	8.63"	1400	90	Dry
TH721	LED Track Head; 36°	Matte White	30	6.71"	3.14"	6.63"	9.06"	2100	90	Dry
TH722	LED Track Head; 36°	Matte Black	30	6.71"	3.14"	6.63"	9.06"	2100	90	Dry
TH723	LED Track Head; 48°	Matte White	30	6.71"	3.14"	6.63"	9.06"	2100	90	Dry
TH724	LED Track Head; 48°	Matte Black	30	6.71"	3.14"	6.63"	9.06"	2100	90	Dry



For Use with H-Type Track

Lumens measured at LED source

3 Conductor "H" type system



H TYPE  
TH701 - 5" L (shown)  
Matte White



H TYPE  
TH712 - 6" L (shown)  
Matte Black



H TYPE  
TH721 - 7" L (shown)  
Matte White

## FINISH OPTIONS



Matte Black



Matte White

5-CCT SELECTABLE - 2700K | 3000K | 3500K | 4000K | 5000K

ITEM	DESCRIPTION	FINISH	WATTS	LENGTH	WIDTH	HEIGHT	EXT.	LUMENS	CRI	CERT. TYPE
<b>J-Type</b>										
TH5001	LED Track Head; 36°	Matte White	10	5"	2"	5.38"	7.75"	700	90	Dry
TH5002	LED Track Head; 36°	Matte Black	10	5"	2"	5.38"	7.75"	700	90	Dry
TH5003	LED Track Head; 48°	Matte White	10	5"	2"	5.38"	7.75"	700	90	Dry
TH5004	LED Track Head; 48°	Matte Black	10	5"	2"	5.38"	7.75"	700	90	Dry
TH5011	LED Track Head; 36°	Matte White	20	6.31"	2.43"	5.88"	8.63"	1400	90	Dry
TH5012	LED Track Head; 36°	Matte Black	20	6.31"	2.43"	5.88"	8.63"	1400	90	Dry
TH5013	LED Track Head; 48°	Matte White	20	6.31"	2.43"	5.88"	8.63"	1400	90	Dry
TH5014	LED Track Head; 48°	Matte Black	20	6.31"	2.43"	5.88"	8.63"	1400	90	Dry
TH5021	LED Track Head; 36°	Matte White	30	6.71"	3.14"	6.63"	9.06"	2100	90	Dry
TH5022	LED Track Head; 36°	Matte Black	30	6.71"	3.14"	6.63"	9.06"	2100	90	Dry
TH5023	LED Track Head; 48°	Matte White	30	6.71"	3.14"	6.63"	9.06"	2100	90	Dry
TH5024	LED Track Head; 48°	Matte Black	30	6.71"	3.14"	6.63"	9.06"	2100	90	Dry



For Use with J-Type Track

Lumens measured at LED source  
3 Conductor "J" type system



J TYPE  
TH5002 - 5" L (shown)  
Matte Black



J TYPE  
TH5011 - 6" L (shown)  
Matte White



J TYPE  
TH5022 - 7" L (shown)  
Matte Black

FINISH OPTIONS



Matte Black



Matte White

# LED TRACK HEADS

BEAM ADJUSTABLE

5-CCT SELECTABLE - 2700K | 3000K | 3500K | 4000K | 5000K

ITEM	DESCRIPTION	FINISH	WATTS	LENGTH	WIDTH	HEIGHT	EXT.	LUMENS	CRI	CERT. TYPE
<b>J-Type</b>										
TH5031	LED Track Head; 20° - 50°	Matte White	15	6.31"	2.43"	5.88"	8.63"	1050	90	Dry
TH5032	LED Track Head; 20° - 50°	Matte Black	15	6.31"	2.43"	5.88"	8.63"	1050	90	Dry
TH5041	LED Track Head; 20° - 50°	Matte White	30	6.94"	3.14"	6.63"	9.25"	2100	90	Dry
TH5042	LED Track Head; 20° - 50°	Matte Black	30	6.94"	3.14"	6.63"	9.25"	2100	90	Dry
<b>H-Type</b>										
TH731	LED Track Head; 20° - 50°	Matte White	15	6.31"	2.43"	5.88"	8.63"	1050	90	Dry
TH732	LED Track Head; 20° - 50°	Matte Black	15	6.31"	2.43"	5.88"	8.63"	1050	90	Dry
TH741	LED Track Head; 20° - 50°	Matte White	30	6.94"	3.14"	6.63"	9.25"	2100	90	Dry
TH742	LED Track Head; 20° - 50°	Matte Black	30	6.94"	3.14"	6.63"	9.25"	2100	90	Dry



Lumens measured at LED source  
3 Conductor "H" type or "J" type system



H TYPE  
TH731 - 6" L (shown)  
Matte White

J TYPE  
TH5031 - 6" L ■ TH5032 - 6" L  
Matte White ■ Matte Black



H TYPE  
TH742 - 7" L (shown)  
Matte Black

J TYPE  
TH5041 - 7" L ■ TH5042 - 7" L  
Matte White ■ Matte Black

## FINISH OPTIONS



Matte White



Matte Black



For Use with H-Type Track



For Use with J-Type Track

# TRACK LIGHT BAR

ITEM	DESCRIPTION	FINISH	LIGHT SOURCE	WATTS	LENGTH	WIDTH	HEIGHT	HEAD EXT.	CCT	LUMENS	CRI	CERT. TYPE
TH500	LED Track Light Bar; 30°	White	LED	15	13.5"	1.5"	1.25"	2"	3000K	960	90	Dry
TH501	LED Track Light Bar; 30°	Black	LED	15	13.5"	1.5"	1.25"	2"	3000K	960	90	Dry
TH502	LED Track Light Bar; 30°	White	LED	30	24"	1.5"	1.25"	2"	3000K	1020	90	Dry
TH503	LED Track Light Bar; 30°	Black	LED	30	24"	1.5"	1.25"	2"	3000K	1020	90	Dry
TH504	LED Track Light Bar; 30°	White	LED	45	34.5"	1.5"	1.25"	2"	3000K	1020	90	Dry
TH505	LED Track Light Bar; 30°	Black	LED	45	34.5"	1.5"	1.25"	2"	3000K	1020	90	Dry
TH506	LED Track Light Bar; 30°	White	LED	60	44.75"	1.5"	1.25"	2"	3000K	1020	90	Dry
TH507	LED Track Light Bar; 30°	Black	LED	60	44.75"	1.5"	1.25"	2"	3000K	1020	90	Dry



Lumens measured at LED source  
3 Conductor "H" type system



TH500 - 14" L (shown)  
White



TH502 - 24" L (shown)  
White



TH505 - 35" L (shown)  
Black



TH506 - 45" L (shown)  
White

## FINISH OPTIONS



White



Black



For Use with H-Type Track

# TRACK HEADS

## R20 STEP CYLINDER

Dimensions: Height 3.5", Width 3.5", Length 5.5", Ext. 8.5"

(1) R20/PAR20 50W max. / Medium Base

TH204 White

TH205 Black

TH303 Brushed Nickel

TH341 Russet Bronze (shown)



## R20 STRAIGHT CYLINDER

Dimensions: Height 3.5", Width 3.5", Length 6", Ext. 9.38"

(1) R20/PAR20 50W max. / Medium Base

TH200 White

TH201 Black

TH307 Brushed Nickel (shown)

TH343 Russet Bronze



## R20 BULLET CYLINDER

Dimensions: Height 3.5", Width 3.5", Length 6", Ext. 8.5"

(1) R20/PAR20 50W max. / Medium Base

TH208 White

TH209 Black (shown)

TH305 Brushed Nickel

TH345 Russet Bronze



## R30 STEP CYLINDER

Dimensions: Height 4.5", Width 4.5", Length 6.25", Ext. 9.5"

(1) R30/PAR30 75W max. (Long Neck) / Medium Base

TH206 White

TH207 Black

TH304 Brushed Nickel (shown)

TH342 Russet Bronze



## R30 STRAIGHT CYLINDER

Dimensions: Height 4.5", Width 4.5", Length 7", Ext. 10"

(1) R30/PAR30 75W max. (Long Neck) / Medium Base

TH202 White

TH203 Black

TH308 Brushed Nickel

TH344 Russet Bronze (shown)



**R30 BULLET CYLINDER**

Dimensions: Height 4.5", Width 4.5", Length 7", Ext. 10"  
(1) R30/PAR30 75W max. (Long Neck) / Medium Base  
TH210 White (shown)  
TH211 Black  
TH306 Brushed Nickel  
TH346 Russet Bronze



**PAR20 SHORT BULLET CYLINDER**

Dimensions: Height 3.5", Width 3.5", Length 4.5", Ext. 7"  
(1) PAR20 50W max. / Medium Base  
TH216 White (shown)  
TH217 Black



**PAR30 SHORT BULLET CYLINDER**

Dimensions: Height 4.5", Width 4.5", Length 5.38", Ext. 8.75"  
(1) PAR30 75W max. / Medium Base  
TH218 White  
TH219 Black (shown)



**PAR20 GIMBAL RING**

Dimensions: Height 2.75", Width 2.75", Length 4.38" Ext. 6.63"  
(1) PAR20 50W max. / Medium Base  
TH220 White  
TH221 Black  
TH300 Brushed Nickel (shown)  
TH347 Russet Bronze



**PAR30 GIMBAL RING**

Dimensions: Height 4", Width 4", Ext. 9.38"  
(1) PAR30 75W max. / Medium Base  
TH222 White (shown)  
TH223 Black  
TH301 Brushed Nickel  
TH348 Russet Bronze



# TRACK HEADS

## PAR38 GIMBAL RING

Dimensions: Height 5", Width 5", Length 6.38", Ext. 9.88"  
(1) PAR38 150W max. / Medium Base  
TH224 White  
TH225 Black (shown)  
TH302 Brushed Nickel  
TH349 Russet Bronze



## PAR30 EURO STYLE

Dimensions: Height 7.5", Width 4.5", Length 4.5", Ext. 8.5"  
(1) PAR30 75W max. / (short neck) Medium Base  
TH332 White  
TH333 Black  
TH331 Brushed Nickel (shown)



## R40 STRAIGHT CYLINDER

Dimensions: Height 5.75", Width 5.75", Length 8.13", Ext. 12.75"  
(1) 150W BR40/PAR38/BR38 max. / Medium Base  
TH284 Black



## UNIVERSAL HOLDER

Dimensions: Height 2", Width 2", Length 4.63", Ext. 6.88"  
(1) R20/BR30/BR40/PAR20 /PAR30/PAR38  
150W.max. / Medium Base  
TH226 White  
TH227 Black  
TH324 Brushed Nickel (shown)



## MINI UNIVERSAL HOLDER

Dimensions: Height 2.38", Width 2.38", Length 3.75" Ext. 6.38"  
(1) R20/BR30/BR40/PAR20 /PAR30/ PAR38  
150W.max. / Medium Base  
TH279 White  
TH280 Black (shown)



### MR16 SQUARE

Dimensions: Height 2.25", Width 2.25", Length, 2.38", Ext. 5.88"  
(1) 50W MR16 / GU10 base 120V max.  
TH312 White  
TH313 Black (shown)  
TH314 Brushed Nickel



### MR16 ROUND BACK

Dimensions: Height 2.75", Width 2.75", Length 4.13", Ext. 6.5"  
(1) 50W MR16 / GU10 base 120V max.  
TH315 White  
TH316 Black  
TH317 Brushed Nickel (shown)  
TH351 Russet Bronze



### MR16 GIMBAL RING

Dimensions: Height 2.13", Width 2.13", Length 3.25", Ext. 5.13"  
(1) 50W MR16 / GU10 base 120V max.  
TH321 White  
TH322 Black  
TH323 Brushed Nickel  
TH352 Russet Bronze (shown)



### 12V MR16 SQUARE

Dimensions: Height 2.25", Width 2.25", Length 2.31", Ext. 5.88"  
(1) 50W MR16 12V max. / GX5.3 Base  
TH232 White (shown)  
TH233 Black



### 12V MR16 ROUND

Dimensions: Height 2.25", Width 2.25", Length 2.75", Ext. 6.375"  
(1) 50W MR16 12V max. / GX5.3 Base  
TH234 White  
TH235 Black (shown)



### 12V MR16 GIMBAL RING

Dimensions: Height 2.13", Width 2.13", Length 3.25", Ext. 5.13"  
(1) 50W MR16 12V max. / GX5.3 Base  
TH238 White (shown)  
TH239 Black



# LED TRACK KITS



TK413 - 3" W  
White



TK423 - 3" W  
White



TK414 - 3" W  
Black



TK424 - 3" W  
Black



TK417 - 3" W  
Brushed Nickel



TK427 - 3" W  
Brushed Nickel

## FINISH OPTIONS



White

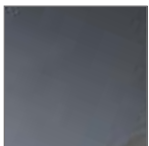

Black



Brushed Nickel

## 4' TRACK KITS

ITEM	DESCRIPTION	FINISH	LIGHT SOURCE	TOTAL WATTS	HEAD LENGTH	HEAD WIDTH	HEAD HEIGHT	HEAD EXT.	CCT	TOTAL LUMENS	CRI	CERT. TYPE
TK403	LED Track Kit; Round 36°	White	LED	36	2.25"	3.25"	3.25"	7.13"	3000K	3060	90	Dry
TK404	LED Track Kit; Round 36°	Black	LED	36	2.25"	3.25"	3.25"	7.13"	3000K	3060	90	Dry
TK407	LED Track Kit; Round 36°	Brushed Nickel	LED	36	2.25"	3.25"	3.25"	7.13"	3000K	3060	90	Dry
TK413	LED Track Kit; Pinch Back 36°	White	LED	36	3.63"	2.88"	2.88"	5.5"	3000K	3060	90	Dry
TK414	LED Track Kit; Pinch Back 36°	Black	LED	36	3.63"	2.88"	2.88"	5.5"	3000K	3060	90	Dry
TK417	LED Track Kit; Pinch Back 36°	Brushed Nickel	LED	36	3.63"	2.88"	2.88"	5.5"	3000K	3060	90	Dry
TK423	LED Track Kit; Angle Arm 36°	White	LED	36	3.38"	2.75"	2.75"	5.75"	3000K	3060	90	Dry
TK424	LED Track Kit; Angle Arm 36°	Black	LED	36	3.38"	2.75"	2.75"	5.75"	3000K	3060	90	Dry
TK427	LED Track Kit; Angle Arm 36°	Brushed Nickel	LED	36	3.38"	2.75"	2.75"	5.75"	3000K	3060	90	Dry



Lumens measured at LED source  
3 Conductor "H" type system  
Track Length - 48"



TK403 - 3" W  
White



TK407 - 3" W  
Brushed Nickel



TK404 - 3" W  
Black

### Kits Include

- 4' track with end caps • 3 Track heads
- Floating canopy power feed • mounting hardware



3 Conductor "H"  
type connector



Track with end  
cap removed



supplied with floating  
canopy kit.

# 4' TRACK KITS



## PAR30 GIMBAL RING

Head Dimensions: Height 4", Width 4", Length 6", Ext. 9.38"  
 (3) PAR30 75W max. / Medium Base  
 TK316 White

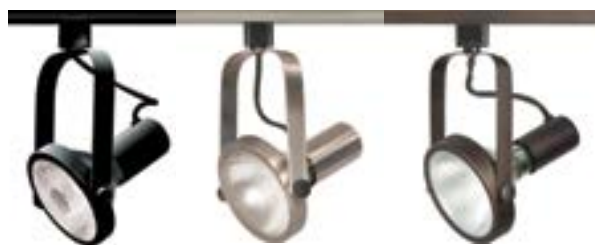

TK317 Black  
 TK343 Brushed Nickel  
 TK362 Russet Bronze



## R30 STRAIGHT CYLINDER

Head Dimensions: Height 4.5", Width 4.5", Length 7", Ext. 10"  
 (3) R30/PAR30 75W max. / Medium Base  
 TK318 White



TK319 Black  
 TK341 Brushed Nickel



## R30 STEP CYLINDER

Head Dimensions: Height 4.5", Width 4.5", Length 6.25", Ext. 9.5"  
 (3) R30/PAR30 75W max. / Medium Base  
 TK320 White



TK321 Black  
 TK340 Brushed Nickel  
 TK361 Russet Bronze



## R30 BULLET CYLINDER

Head Dimensions: Height 4.5", Width 4.5", Length 7", Ext. 10"  
 (3) R30/PAR30 75W max. / Medium Base  
 TK322 White



TK323 Black  
 TK342 Brushed Nickel

## Kits Include

- (1) Four foot track
- (1) Floating power feed canopy kit
- (3) Track lighting heads
- All necessary mounting hardware



### MR16 SQUARE

Head Dimensions: Height 2.25", Width 2.25", Length 2.38", Ext. 5.88"  
 (3) 50W MR16 / GU10 base 120V max.  
 TK345 White



TK346 Black  
 TK347 Brushed Nickel



### MR16 ROUND BACK

Head Dimensions: Height 2.75", Width 2.75", Length 4.13", Ext. 6.5"  
 (3) 50W MR16 / GU10 base 120V max.  
 TK348 White



TK349 Black  
 TK354 Brushed Nickel



### MR16 GIMBAL RING

Head Dimensions: Height 2.13", Width 2.13", Length 3.25", Ext. 5.13"  
 (3) 50W MR16 / GU10 base 120V max.  
 TK355 White



TK352 Black  
 TK353 Brushed Nickel



### MR16 SQUARE

Head Dimensions: Height 2.25", Width 2.25", Length 2.31",  
 Ext. 5.88" (3) 50W MR16 / GX5.3 base 12V max.  
 TK310 White



### MR16 GIMBAL RING

Head Dimensions: Height 2.13", Width 2.13", Length 3.25",  
 Ext. 5.13" (3) 50W MR16 / GX5.3 base 12V max.  
 TK315 Black

# TRACK ACCESSORIES

ITEM	DESCRIPTION	FINISH	LENGTH	WIDTH	HEIGHT	CERT.
TR118	2 Foot Track, 2 Dead End Caps, All Mounting Hardware	White	24"	1.31"	.63"	Dry
TR119	2 Foot Track, 2 Dead End Caps, All Mounting Hardware	Black	24"	1.31"	.63"	Dry
TR120	4 Foot Track, 2 Dead End Caps, All Mounting Hardware	White	48"	1.31"	.63"	Dry
TR121	4 Foot Track, 2 Dead End Caps, All Mounting Hardware	Black	48"	1.31"	.63"	Dry
TR122	8 Foot Track, 2 Dead End Caps, All Mounting Hardware	White	96"	1.31"	.63"	Dry
TR123	8 Foot Track, 2 Dead End Caps, All Mounting Hardware	Black	96"	1.31"	.63"	Dry
TR124	6 Foot Track, 2 Dead End Caps, All Mounting Hardware	White	72"	1.31"	.63"	Dry
TR125	6 Foot Track, 2 Dead End Caps, All Mounting Hardware	Black	72"	1.31"	.63"	Dry
TR126	2 Foot Track, 2 Dead End Caps, All Mounting Hardware	Brushed Nickel	24"	1.31"	.63"	Dry
TR127	4 Foot Track, 2 Dead End Caps, All Mounting Hardware	Brushed Nickel	48"	1.31"	.63"	Dry
TR128	6 Foot Track, 2 Dead End Caps, All Mounting Hardware	Brushed Nickel	72"	1.31"	.63"	Dry
TR129	8 Foot Track, 2 Dead End Caps, All Mounting Hardware	Brushed Nickel	96"	1.31"	.63"	Dry
TR131	2 Foot Track, 2 Dead End Caps, All Mounting Hardware	Russet Bronze	24"	1.31"	.63"	Dry
TR132	4 Foot Track, 2 Dead End Caps, All Mounting Hardware	Russet Bronze	48"	1.31"	.63"	Dry
TR133	6 Foot Track, 2 Dead End Caps, All Mounting Hardware	Russet Bronze	72"	1.31"	.63"	Dry
TR134	8 Foot Track, 2 Dead End Caps, All Mounting Hardware	Russet Bronze	96"	1.31"	.63"	Dry
TP185	Drop Ceiling T-Bar Clips, for attaching Track Lighting to Drop Ceilings; 4 Pc.	Metal Plain	1.50"	0.5"	.88"	Dry

## Tracks Includes two dead end caps and All Mounting Hardware.



TR120



TR121



TR127



TR131



TRACK WITH END CAP REMOVED

## Drop Ceiling T-Bar Track Clips



TP185

(4 pieces per package • 90-018 nut not included)

## H-Type System



Used with  
3 Conductor "H"  
type track

## J-Type System



Used with  
3 Conductor "J"  
type track

## Extensions Lowers Track Heads to desired height

ITEM	DESCRIPTION	SIZE	FINISH
TP159	Extension Wand Carded	18"	White
TP160	Extension Wand	24"	White
TP161	Extension Wand	36"	White
TP162	Extension Wand	48"	White
TP163	Extension Wand	18"	Black
TP164	Extension Wand	24"	Black
TP165	Extension Wand	36"	Black
TP166	Extension Wand	48"	Black



24" Pendant  
Suspension Kit

Kit Includes:  
canopy,  
stem, support and  
power feed

ACCESSORIES

TP178 White  
TP179 Black



TP159 18"  
Extension

Shown with  
PAR38  
track head  
and 120V  
monopoint  
adapter

# TRACK | CURRENT LIMITERS | EXTENSIONS | ETC.

## Live End Cord Kit



LINE VOLTAGE (120V)

ITEM	FINISH
TP156	White
TP157	Black
TP201	Brown

## Canopies & Live Ends Providing electricity to tracks in various formats



FLOATING

ITEM	FINISH
TP154	White
TP155	Black
TP202	Brown



CONDUIT LIVE END

ITEM	FINISH
TP169	White
TP170	Black
TP203	Brown
TP269	White REV. POL.
TP270	Black REV. POL.



LIVE END & CANOPY

ITEM	FINISH
TP152	White
TP153	Black
TP204	Brown
TP218	White REV. POL.
TP219	Black REV. POL.
TP220	Brown REV. POL.



INLINE FEED

ITEM	FINISH
TP171	White
TP172	Black
TP211	Brown

## Connectors Connecting tracks in various formats



STRAIGHT

ITEM	FINISH
TP144	White
TP145	Black
TP205	Brown



"L" CONNECTOR (90° ANGLES)

ITEM	FINISH
TP146	White
TP147	Black
TP208	Brown
TP234	Black REV. POL.
TP235	White REV. POL.
TP236	Brown REV. POL.



"T" CONNECTOR

ITEM	FINISH
TP148	White
TP149	Black
TP207	Brown
TP237	Black REV. POL.
TP238	White REV. POL.
TP239	Brown REV. POL.



"X" CONNECTOR

ITEM	FINISH
TP150	White
TP151	Black
TP206	Brown



FLEXIBLE

ITEM	FINISH
TP167	White
TP168	Black
TP209	Brown

## Live End Current Limiters for use with 120V Track Systems Only

ITEM	AMP	FINISH
TL100	0.5	White
TL101	1.0	White
TL102	2.0	White
TL103	3.0	White
TL104	5.0	White
TL105	8.0	White
TL106	12.0	White



TL100

ITEM	AMP	FINISH
TL110	0.5	Black
TL111	1.0	Black
TL112	2.0	Black
TL113	3.0	Black
TL114	5.0	Black
TL115	8.0	Black
TL116	12.0	Black



TL110



# TRACK ACCESSORIES

ITEM	DESCRIPTION	FINISH	LENGTH	WIDTH	HEIGHT	CERT.
TP240	Track Suspension Aircraft Cable; White Canopy	White	144"	•	•	Dry
TP241	Track Suspension Aircraft Cable; Black Canopy	Black	144"	•	•	Dry
TP242	Track Suspension Aircraft Cable; Brushed Nickel Canopy	Brushed Nickel	144"	•	•	Dry
TP176	Offset Monopoint Adapter; Low Voltage	White	4.63"	4.63"	0.5"	Dry
TP177	Offset Monopoint Adapter; Low Voltage	Black	4.63"	4.63"	0.5"	Dry
TP142	Monopoint Adapter; Line Voltage	White	5"	5"	0.5	Dry
TP143	Monopoint Adapter; Line Voltage	Black	5"	5"	0.5	Dry
TP247	Single Monopoint Adapter; Round	Black	4.72"	4.72"	1"	Dry
TP248	Single Monopoint Adapter; Round	White	4.72"	4.72"	1"	Dry
TP249	Triple Monopoint Adapter; Round	Black	12"	12"	1"	Dry
TP250	Triple Monopoint Adapter; Round	White	12"	12"	1"	Dry
TP251	Double Monopoint Adapter; Rectangular	Black	9.25"	4.62"	1"	Dry
TP252	Double Monopoint Adapter; Rectangular	White	9.25"	4.62"	1"	Dry
TP253	Triple Monopoint Adapter; Rectangular	Black	14.75"	4.62"	1"	Dry
TP254	Triple Monopoint Adapter; Rectangular	White	14.75"	4.62"	1"	Dry
TP255	Outlet Track Adapter	Black	1.42"	1.42"	2.66"	Dry
TP256	Outlet Track Adapter	White	1.42"	1.42"	2.66"	Dry
TP257	Outlet Track Adapter	Brown	1.42"	1.42"	2.66"	Dry
TP231	Pendant Track Adapter	White	3"	1.38"	1.38"	Dry
TP232	Pendant Track Adapter	Black	3"	1.38"	1.38"	Dry
TP233	Pendant Track Adapter	Brown	3"	1.38"	1.38"	Dry
TP215	Pendant Loop Track Adapter	White	1.44"	1.44"	3.5"	Dry
TP216	Pendant Loop Track Adapter	Black	1.44"	1.44"	3.5"	Dry
TP217	Pendant Loop Track Adapter	Brown	1.44"	1.44"	3.5"	Dry
TP244	Pendant Loop Track Adapter; Stem Hung	White	3"	1.38"	1.38"	Dry
TP245	Pendant Loop Track Adapter; Stem Hung	Black	3"	1.38"	1.38"	Dry
TP246	Pendant Loop Track Adapter; Stem Hung	Brown	3"	1.38"	1.38"	Dry
TP258	Sloped Ceiling Track Adapter	Black	1.38"	1.42"	4.72"	Dry
TP259	Sloped Ceiling Track Adapter	White	1.38"	1.42"	4.72"	Dry
TP260	Sloped Ceiling Track Adapter	Brown	1.38"	1.42"	4.72"	Dry

## Track Suspension Aircraft Cables 2 per 2ft & 4ft of track | 4 per 6ft & 8ft of track



TP240 | White Canopy



TP241 | Black Canopy



TP242 | Brushed Nickel Canopy

## Monopoint Adapters | Line Voltage (120V)



TP142

TP143

## Offset Monopoint Adapters | Low Voltage (12V)



TP176

TP177

## ADDITIONAL ADAPTORS | SUSPENSION AIRCAFT CABLES

### Single Monopoint Adapters | Round



TP247



TP248

### Triple Monopoint Adapters | Round



TP249



TP250

### Double Monopoint Adapters | Rectangular



TP252



TP251

### Triple Monopoint Adapters | Rectangular



TP254



TP253

Allows for 600W Max / 120V

### Pendant Track Adapters

Supports up to 10 lbs.



#### LOOP ADAPTER

ITEM	FINISH
TP215	White
TP216	Black
TP217	Brown



#### TRACK ADAPTER

ITEM	FINISH
TP231	White
TP232	Black
TP233	Brown



#### STEM-HUNG ADAPTER

ITEM	FINISH
TP244	White
TP245	Black
TP246	Brown



#### OUTLET TRACK ADAPTERS

ITEM	FINISH
TP255	Black
TP256	White
TP257	Brown

Allows for 600 Max Watts / 5 Amps.



#### SLOPED CEILING TRACK ADAPTERS

ITEM	FINISH
TP258	Black
TP259	White
TP260	Brown

Allow for 360° track head range of motion.



# EXTERIOR design

## MAKE AN ENTRANCE

Make each entrance into your home a welcoming one with our selection of finely conceived outdoor lighting collections. Whether a traditional coach lantern style or a contemporary LED architectural design, each product will guarantee that the first design statement your guests will see sets the mood of what is to come.





# CRADLE LED

3-CCT SELECTABLE - 2700K | 3000K | 5000K

The Cradle wall lanterns make a stylish, unique impression on a home's exterior with their contemporary-modern design. The long scoop saddles a perfect orb of opal-white glass that houses an integrated LED light source. At only 6 watts, these fixtures help keep costs down. The lanterns are an ideal solution for decorative outdoor lighting.

## FINISH



Matte Black w/  
White opal Glass

ITEM	DESCRIPTION	FINISH	LIGHT SOURCE	WATTS	WIDTH	HEIGHT	EXT.	CCT	LUMENS	CRI	CERT TYPE
62-1619	Med. Wall Lantern	Matte Black w/ White Opal Glass	LED	6W	6"	12"	5.75"	3000K	550	90+	Wet
62-1620	Lg.. Wall Lantern	Matte Black w/ White Opal Glass	LED	6W	6"	15"	5.75"	3000K	550	90+	Wet



Lumens measured at LED source



62-1619 - 12" H



62-1620 - 15" H



# ATMOSPHERE LED

The Atmosphere LED series makes a giant impact with its minimal design. The integrated LED module is housed within a sphere of matte black finished metal with opal or Clear Seeded glass, and is suitable for all exterior applications. The single-arm extends and curves downward, continuing the simple design surrounding this fixture.

## FINISH OPTIONS



Matte Black w/  
White Opal Glass



Matte Black w/  
Clear Seeded Glass

ITEM	DESCRIPTION	FINISH	LIGHT SOURCE	WATTS	WIDTH	HEIGHT	EXT.	CCT	LUMENS	CRI	CERT TYPE
62-1615	Med. Wall Lantern	Matte Black w/ White Opal Glass	LED	6W	8"	12.88"	9.5"	3000K	550	90+	Wet
62-1616	Med. Wall Lantern	Matte Black w/ Clear Seeded Glass	LED	6W	8"	12.88"	9.5"	3000K	550	90+	Wet
62-1617	Lg. Wall Lantern	Matte Black w/ White Opal Glass	LED	10W	10"	16.38"	11.63"	3000K	900	90+	Wet
62-1618	Lg. Wall Lantern	Matte Black w/ Clear Seeded Glass	LED	10W	10"	16.38"	11.63"	3000K	900	90+	Wet



62-1615 - 8" W  
Matte Black w/  
White Opal Glass



62-1616 - 8" W  
Matte Black w/  
Clear Seeded Glass



62-1617 - 10" W  
Matte Black w/  
White Opal Glass



62-1618 - 10" W  
Matte Black w/  
Clear Seeded Glass



# SUPREME LED

The Supreme LED outdoor wall lanterns suit modern and contemporary styling perfectly. The integrated LED illuminates downward, adding visual interest to the design with the clean lines of the rectangular frame. A versatile matte black finish complements existing fixtures and finishes.

## FINISH

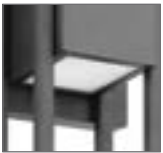

Matte Black w/  
Frosted Glass

ITEM	DESCRIPTION	FINISH	LIGHT SOURCE	WATTS	WIDTH	HEIGHT	EXT.	CCT	LUMENS	CRI	CERT TYPE
62-1653	Sm. Wall Lantern	Matte Black w/ Frosted Glass	LED	10W	4.875"	11"	4.25"	3000K	550	90+	Wet
62-1654	Med. Wall Lantern	Matte Black w/ Frosted Glass	LED	18W	5.375"	13"	5.375"	3000K	1600	90+	Wet
62-1655	Lg. Wall Lantern	Matte Black w/ Frosted Glass	LED	18W	6.875"	17"	6.75"	3000K	1600	90+	Wet

Lumens measured at LED source



62-1653 - 11" H



62-1654 - 13" H



62-1655 - 17" H



# LEDGES LED

The Ledges collection blends a simplistic design with great style. Perfect for modern homes to add some dynamic, artistic, and impactful lighting to the exterior.

## FINISH OPTIONS



Matte Black  
White Opal Glass



Matte Black  
Seeded Glass

ITEM	DESCRIPTION	FINISH	LIGHT SOURCE	WATTS	WIDTH	HEIGHT	EXT.	CCT	LUMENS	CRI	CERT. TYPE
62-1611	1 Lt. Med. Wall Lantern	Matte Black / Opal Glass	LED	6W	5.5"	16"	6.5"	3000K	550	90	Wet
62-1612	1 Lt. Med. Wall Lantern	Matte Black / Seeded Glass	LED	6W	5.5"	16"	6.38"	3000K	550	90	Wet
62-1613	1 Lt. Lg. Wall Lantern	Matte Black / Opal Glass	LED	10W	7"	22.5"	7.78"	3000K	900	90	Wet
62-1614	1 Lt. Lg. Wall Lantern	Matte Black / Seeded Glass	LED	10W	7"	22.5"	7.78"	3000K	900	90	Wet



62-1611 - 16" Ht  
Opal Glass



62-1612 - 16" Ht  
Opal Glass



62-1613 - 23" Ht (shown)  
Seeded Glass



62-1614 - 23" Ht  
Seeded Glass



# COLT LED

With classic tradition and modern flair, the Colt Series re-imagines the traditional lantern with a contemporary twist, offering the perfect blend of design and modern innovation. From porches to patios, the Colt Series brings enduring style and energy-efficient illumination to your outdoor spaces, tradition reborn for today.

## FINISH



Matte Black

ITEM	DESCRIPTION	FINISH	LIGHT SOURCE	WATTS	WIDTH	HEIGHT	EXT.	CCT	LUMENS	CRI	CERT. TYPE
62-2310	Sm. Outdoor Lantern	Matte Black	LED	10W	5.5"	11.75"	6.88"	3000K	326	90	Wet
62-2311	Med. Outdoor Lantern	Matte Black	LED	10W	7.38"	15.5"	9"	3000K	389	90	Wet
62-2312	Lg. Outdoor Lantern	Matte Black	LED	10W	9.5"	20"	11.25"	3000K	370	90	Wet
62-2313	Outdoor Post Lantern	Matte Black	LED	10W	9.5"	20"	•	3000K	394	90	Wet
62-2314	Hanging Pendant	Matte Black	LED	10W	9.5"	21.63"	•	3000K	386	90	Damp



62-2314 - 10" W



62-2310 - 6" W



62-2311 - 7" W



62-2313 - 10" W



62-2312 - 10" W

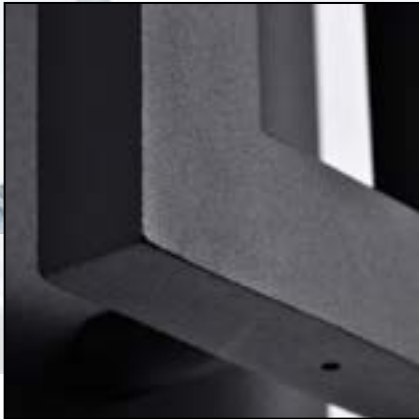

# CREW LED

Bring bold simplicity with the Crew Series, outdoor lighting with a sleek, architectural design that is as striking as it is decorative. Its clean lines and minimalist form make it an ideal choice for those who appreciate contemporary design with a refined edge.

## FINISH



Sand Black

ITEM	DESCRIPTION	FINISH	LIGHT SOURCE	WATTS	LENGTH	WIDTH	HEIGHT	EXT.	CCT	LUMENS	CRI	CERT TYPE
62-2301	15" Outdoor Sconce	Sand Black	LED	32W	•	5"	15"	3.5"	3000K	360	90	Wet
62-2302	19" Outdoor Sconce	Sand Black	LED	40W	•	7"	19.13"	3.88"	3000K	898	90	Wet



62-2301 - 15" Ht



62-2302 - 19" Ht



# RAVEN LED

Lighting that brings bold style and understated design can be found in a Modern package with the Raven outdoor wall lanterns. A seamless integration with its versatile finish, streamlined silhouette, LED technology, deliver decorative illumination at its finest.

ITEM	DESCRIPTION	FINISH	LIGHT SOURCE	WATTS	CCT	LUMENS	CRI	WIDTH	HEIGHT	EXT.	CERT. TYPE
62-1425	10" Sconce	Textured Matte Black	LED	8W	3000K	660	90	4.75"	10"	4"	Wet
62-1426	18" Sconce	Textured Matte Black	LED	15W	3000K	1180	90	4.75"	18"	4"	Wet



62-1425 - 10" Ht



62-1426 - 18" Ht

## FINISH



Textured Matte Black



# LIGHTGATE LED

The Lightgate LED wall sconce creates the perfect mood for outside lighting. It's contemporary and stylish, perfect for lighting your homes exterior and washing it in a glow of warm white light.

ITEM	DESCRIPTION	FINISH	LIGHT SOURCE	WATTS	WIDTH	HEIGHT	EXT.	CCT	LUMENS	CRI	CERT. TYPE
62-1464RI	Round Sconce	Matte Black	LED	5W	6"	4.75"	5.5"	3000K	240	90	Wet
62-1465RI	Round Sconce	Matte White	LED	5W	6"	4.75"	5.5"	3000K	240	90	Wet
62-1466RI	Square Sconce	Matte Black	LED	5W	4.75"	4.75"	4.75"	3000K	240	90	Wet
62-1467RI	Square Sconce	Matte White	LED	5W	4.75"	4.75"	4.75"	3000K	240	90	Wet

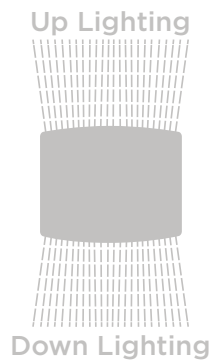

62-1465R1 - 6" W (shown)  
Matte White



62-1466R1 - 5" W (shown)  
Matte Black

BLACK OR WHITE UNITS, FEATURE ADJUSTABLE BEAM INTERIOR BARN DOORS.

## FINISH OPTIONS



Matte White

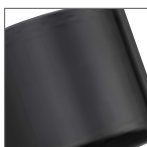

Matte Black



# WILLIS LED

Light the way to your home with the Willis collection. . . a charming lighting solution for outside the home. Illuminate porches, stoops, decks, and walkways with this textured black lantern series.

ITEM	DESCRIPTION	FINISH	NO. OF LIGHTS	LAMP TYPE	WATTS	WIDTH	HEIGHT	EXT.	CCT	LUMENS	CRI	CERT. TYPE
62-651	Sm. Outdoor Lantern	Textured Black/Antique White Glass	1	LED	10W	7.25"	15.125"	8.125"	3000K	800	90	Wet
62-652	Med. Outdoor Lantern	Textured Black/Antique White Glass	1	LED	10W	9"	17.625"	9.75"	3000K	800	90	Wet
62-653	Outdoor Flush Mount	Textured Black/Antique White Glass	2	LED	10W	13.75"	5.875"	•	3000K	800	90	Wet
62-654	Outdoor Post Lantern	Textured Black/Antique White Glass	1	LED	10W	9"	19.875"	•	3000K	800	90	Wet
62-655	Hanging Lantern	Textured Black/Antique White Glass	1	LED	10W	9"	19.875"	•	3000K	800	90	Damp

Additional chain: (3') 25-6407

Pier Mount Base: 25-6406

Hanging fixture: 12' of wire and 4' of chain supplied



62-651 - 7" W



62-652 - 9" W

## FINISH



Textured Black  
Antique White Glass

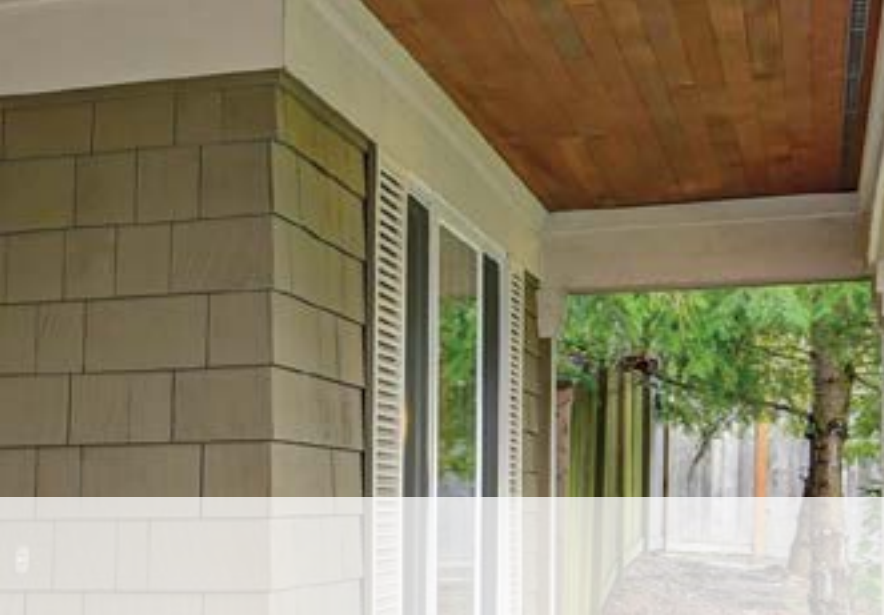

62-655 - 9" W



62-653 - 14" W



62-654 - 9" W



LED Omni "A"  
lamps included



# DIEGO LED



The Diego series is a charming lighting solution for outside the home. Illuminate porches, stoops, walkways, and decks with a single A19 bulb that sits behind satin amber glass, with a structure finished in mahogany bronze.

## FINISH



Mahogany Bronze w/  
Satin Amber glass



62-643 - 13" W

ITEM	DESCRIPTION	FINISH	LIGHT SOURCE	WATTS	WIDTH	HEIGHT	EXT.	CCT	LUMENS	CRI	CERT. TYPE
62-641	Sm. Outdoor Lantern	Mahogany Bronze w/ Satin Amber Glass	LED	10W	5.5"	10.38"	6.25"	3000K	800	90+	Wet
62-642	Med. Outdoor Lantern	Mahogany Bronze w/ Satin Amber Glass	LED	10W	9"	14"	9.75"	3000K	830	90+	Wet
62-643	Outdoor Flush Mount	Mahogany Bronze w/ Satin Amber Glass	LED	10W	13"	5.25"	•	3000K	1660	90+	Wet
62-644	Outdoor Post Lantern	Mahogany Bronze w/ Satin Amber Glass	LED	10W	9"	16.13"	•	3000K	800	90+	Wet
62-645	Hanging Lantern	Mahogany Bronze w/ Satin Amber Glass	LED	10W	9"	14.75"	•	2700K	810	80+	Damp

Lumens measured at LED source

Additional Chain: (3') 25-4225

Hanging Lantern: 12' of wire and 4' of chain supplied



62-645 - 9" W



62-641 - 6" W (shown)



62-644 - 9" W



LED Omni "A"  
lamps included



# BETHANY LED

The Bethany LED outdoor fixtures feature a craftsman style approach to exterior lighting. The satin white glass provides old world charm, and the mahogany bronze finish on the body showcases the design.

ITEM	DESCRIPTION	FINISH	NO. OF LIGHTS	LAMP TYPE	WATTS	WIDTH	HEIGHT	EXT.	CCT	LUMENS	CRI	CERT. TYPE
62-631	Sm. Outdoor Lantern	Mahogany Bronze / Satin White Glass	1	LED	10W	8.5"	14.5"	9.38"	3000K	800	90	Wet
62-632	Med. Outdoor Lantern	Mahogany Bronze / Satin White Glass	1	LED	10W	10"	16.75"	10.88"	3000K	800	90	Wet
62-633	Outdoor Flush Mount	Mahogany Bronze / Satin White Glass	1	LED	10W	10"	8"	•	3000K	830	90	Wet
62-634	Outdoor Post Lantern	Mahogany Bronze / Satin White Glass	1	LED	10W	10"	18.375"	•	3000K	830	90	Wet
62-635	Hanging Lantern	Mahogany Bronze / Satin White Glass	1	LED	10W	10"	15.875"	•	2700K	810	80	Damp

Additional chain: (3') 25-4225

Pier Mount Base: 25-5945

Hanging fixture: 12' of wire and 4' of chain supplied



62-631 - 9" W



62-632 - 10" W



62-634 - 10" W

## FINISH



Mahogany Bronze  
Satin White Glass



62-635 - 10" W



62-633 - 10" W



LED Omni "A"  
lamps included

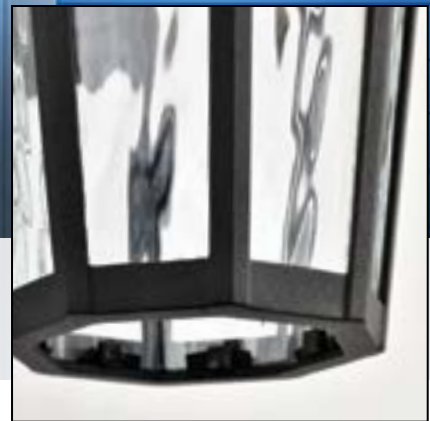

# EAST RIVER LED

## WIFI ENABLED

Embrace the charm of traditional design with the East River Collection, where every detail tells a story of craftsmanship. Opt for traditional bulb application or the latest in LED technology with Starfish capabilities for fine tuning your lighting needs. Create a mesmerizing play of light that beautifully complements your outdoor environment.

### FINISH



Matte Black  
Clear Water Glass



Dynamic RGB  
Color-Changing  
& Tunable White



Millions of Colors



Warm to Cool Tunable White



ITEM	DESCRIPTION	FINISH	LIGHT SOURCE	WATTS	LENGTH	WIDTH	HEIGHT	EXT.	CCT	LUMENS	CERT. TYPE
62-5944	Hanging Lantern	Matte Black	LED	10W	•	8.25"	14.5"	•	RGBTW	•	Damp
62-5945	Wall Lantern	Matte Black	LED	10W	•	6.25"	12"	7.38"	RGBTW	•	Wet



Additional Chain: (3') 25-508

Hanging Lantern: 12' of wire and 4' of chain supplied



62-5944 - 8" W



62-5945 - 6" W

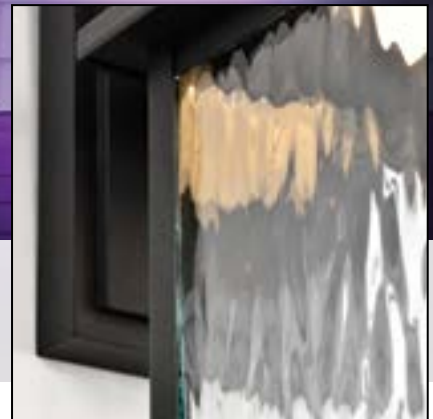

# AUSTEN LED

## WIFI ENABLED

The Austen outdoor series features a classic design that brings a romantic charm to the outdoors in its transitional style. With the Starfish app, it conveys a sense of classic style and allows for optimal lighting control including millions colors to shine bright on your home's exterior.

### FINISH

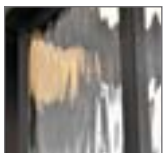

Matte Black  
Clear Water Glass



Dynamic RGB  
Color-Changing  
& Tunable White



Millions of Colors

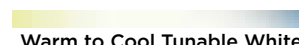

Warm to Cool Tunable White



ITEM	DESCRIPTION	FINISH	LIGHT SOURCE	WATTS	LENGTH	WIDTH	HEIGHT	EXT.	CCT	LUMENS	CERT. TYPE
62-5996	Hanging Lantern	Matte Black	LED	10W	•	7.75"	17.25"	•	RGBTW	•	Damp
62-5997	Wall Lantern	Matte Black	LED	10W	•	6"	13.25"	7.75"	RGBTW	•	Wet



Additional Chain: (3') 25-508

Hanging Lantern: 12' of wire and 4' of chain supplied



62-5996 - 8" W



62-5997 - 6" W



# EAST RIVER

Embrace the charm of traditional design with the East River Collection, where every detail tells a story of craftsmanship. Opt for traditional bulb application or the latest in LED technology with Starfish capabilities for fine tuning your lighting needs. Create a mesmerizing play of light that beautifully complements your outdoor environment.

ITEM	DESCRIPTION	FINISH	NO. OF LIGHTS	LAMP TYPE	BASE	MAX WATTS	WIDTH	HEIGHT	EXT.	CERT. TYPE
60-5943	1 Lt. Post Lantern	Matte Black / Clear Water Glass	1	A19	Med.	100W	8.25"	19.5"	•	Wet
60-5944	1 Lt. Hanging Lantern	Matte Black / Clear Water Glass	1	A19	Med.	100W	8.25"	14.5"	•	Damp
60-5945	1 Lt. Sm. Wall Lantern	Matte Black / Clear Water Glass	1	A19	Med.	100W	6.25"	12"	7.375"	Wet
60-5946	1 Lt. Lg. Wall Lantern	Matte Black / Clear Water Glass	1	A19	Med.	100W	8.25"	15.75"	9.5"	Wet

3' Chain: 25-508

Pier Mount Base: 25-504

Hanging Lantern: 12' of wire and 4' of chain supplied



60-5945 - 6" W (shown)



60-5944 - 8" W



60-5943 - 8" W

## FINISH

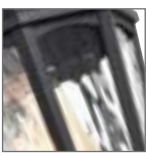

Matte Black  
Clear Water Glass



# AUSTEN

The Austen Lighting Series features a classic design that brings a romantic charm to the outdoors with its transitional style. An elongated metal structure is finished in a versatile matte black to coordinate with existing finishes. The rippling water glass provides glimpses of the bulb while allowing for superior illumination through the clear panels. Conveying a sense of classic style allows this collection to shine bright on your home's exterior.

ITEM	DESCRIPTION	FINISH	NO. OF LIGHTS	LAMP TYPE	BASE	MAX WATTS	WIDTH	HEIGHT	EXT.	CERT. TYPE
60-5995	1 Lt. Post Lantern	Matte Black / Clear Water Glass	1	A19	Med.	100W	7.75"	20.125"	•	Wet
60-5996	1 Lt. Hanging Lantern	Matte Black / Clear Water Glass	1	A19	Med.	100W	7.75"	17.25"	•	Damp
60-5997	1 Lt. Sm. Wall Lantern	Matte Black / Clear Water Glass	1	A19	Med.	100W	6"	13.25"	7.75"	Wet
60-5998	1 Lt. Lg. Wall Lantern	Matte Black / Clear Water Glass	1	A19	Med.	100W	7.75"	17.375"	10"	Wet

3' Chain: 25-508

Pier Mount Base: 25-504

Hanging Lantern: 12' of wire and 4' of chain supplied



60-5997 - 6" W (shown)



60-5996 - 8" W



60-5995 - 8" W

## FINISH



Matte Black  
Clear Water Glass



# STILLWELL



A lantern-style approach to its design makes the Stillwell outdoor series a bona fide hit. A versatile series to match existing fixtures and home exteriors, it features a traditional design that brings grace to the landscape of your home.

ITEM	DESCRIPTION	FINISH	NO. OF LIGHTS	LAMP TYPE	BASE	MAX WATTS	LENGTH	WIDTH	HEIGHT	EXT.	CERT. TYPE
60-5957	1 Lt. Post Lantern	Matte Black / Water Glass	1	A19	Med.	100W	6.5"	6.5"	17.33"	•	Wet
60-5958	1 Lt. Hanging Lantern	Matte Black / Water Glass	1	A19	Med.	100W	6.5"	6.5"	13.78"	•	Wet
60-5959	1 Lt. Wall Lantern	Matte Black / Water Glass	1	A19	Med.	100W	6.5"	6.5"	13.2"	8.25"	Wet

3' Chain: 25-508

Pier Mount Base: 25-504

Hanging Lantern: 12' of wire and 4' of chain supplied



60-5959 - 7" W



60-5958 - 7" W



60-5957 - 7" W

## FINISH

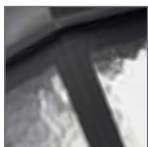

Matte Black  
Water Glass



# LAWRENCE

Whether you have a modern urban retreat or a classic countryside home, the Lawrence Collection effortlessly adapts to your unique style. Versatility is at the heart of these thoughtfully designed fixtures, providing a timeless and cohesive aesthetic that seamlessly integrates with various architectural styles.

ITEM	DESCRIPTION	FINISH	NO. OF LIGHTS	LAMP TYPE	BASE	MAX WATTS	WIDTH	HEIGHT	EXT.	CERT TYPE
60-8131	Sm. Wall Lantern	Matte Black / Clear Seeded Glass	1	A19	Med.	100W	6.125"	14"	9"	Wet
60-8132	Med. Wall Lantern	Matte Black / Clear Seeded Glass	1	A19	Med.	100W	6.125"	16.75"	9"	Wet
60-8133	Lg. Wall Lantern	Matte Black / Clear Seeded Glass	1	A19	Med.	100W	7.625"	21"	11"	Wet
60-8134	Lg. Post Top Lantern	Matte Black / Clear Seeded Glass	1	A19	Med.	100W	7.625"	22.75"	•	Wet
60-8135	Lg. Hanging Lantern	Matte Black / Clear Seeded Glass	1	A19	Med.	100W	7.625"	20"	•	Damp

Additional Chain: (3') 25-508

Pier Mount Base: 25-504

Hanging Lantern: 12' of wire and 4' of chain supplied



60-8131 - 6" W (shown)



60-8135 - 8" W



60-8134 - 8" W

## FINISH



Matte Black  
Clear Seeded Glass



# OAKLYN

Casting a soft glow on your home's exterior, the Oaklyn Collection instantly transforms your outdoor space into a sanctuary of illumination. Set the stage for a memorable evening with beautifully lit surroundings, whether during a fabulous party, or a romantic outdoor dinner under the stars, the ultimate choice for your outdoor space.

ITEM	DESCRIPTION	FINISH	NO. OF LIGHTS	LAMP TYPE	BASE	MAX WATTS	WIDTH	HEIGHT	EXT.	CERT TYPE
60-8121	Sm. Wall Lantern	Matte Black / Clear Glass	1	A19	Med.	100W	4.75"	14"	6"	Wet
60-8122	Med. Wall Lantern	Matte Black / Clear Glass	1	A19	Med.	100W	6"	17"	7.375"	Wet
60-8123	Lg. Wall Lantern	Matte Black / Clear Glass	1	A19	Med.	100W	7.5"	21.125"	9.125"	Wet
60-8124	Post Top Lantern	Matte Black / Clear Glass	1	A19	Med.	100W	7.5"	23.125"	•	Wet
60-8125	Hanging Lantern	Matte Black / Clear Glass	1	A19	Med.	100W	7.5"	19"	•	Damp

Additional Chain: (3') 25-508

Pier Mount Base: 25-504

Hanging Lantern: 12' of wire and 4' of chain supplied



60-8121 - 5" W



60-8122 - 6" W



60-8123 - 8" W

## FINISH



Matte Black  
Clear Glass



60-8125 - 8"



60-8124 - 8" W



# HOPKINS

Reminiscent of Tudor-inspired style, the Hopkins outdoor lighting collection guarantees an elegant grace to your home. This time-honored design will shine brightly on your home's exterior landscape for years to come.

ITEM	DESCRIPTION	FINISH	NO. OF LIGHTS	LAMP TYPE	BASE	MAX WATTS	WIDTH	HEIGHT	EXT.	CERT. TYPE
60-6115	1 Lt. Lg. Post Lantern	Matte Black / Clear Glass	1	A19	Med.	100W	7.38"	18.5"	•	Wet
60-6116	1 Lt. Sm. Post Lantern	Matte Black / Clear Glass	1	A19	Med.	100W	6"	16.56"	•	Wet
60-6117	1 Lt. Hanging Lantern	Matte Black / Clear Glass	1	A19	Med.	100W	7.38"	12.67"	•	Damp
60-6118	1 Lt. Lg. Wall Lantern	Matte Black / Clear Glass	1	A19	Med.	100W	7.38"	13.22"	8.57"	Wet
60-6119	1 Lt. Sm. Wall Lantern	Matte Black / Clear Glass	1	A19	Med.	100W	6"	11.77"	7.77"	Wet

3' Chain: 25-508

Pier Mount Base: 25-504

Hanging Lantern: 12' of wire and 4' of chain supplied



60-6119- 6" W (shown)



60-6117 - 7" W



60-6115 - 7" W (shown)

## FINISH



Matte Black  
Clear Glass

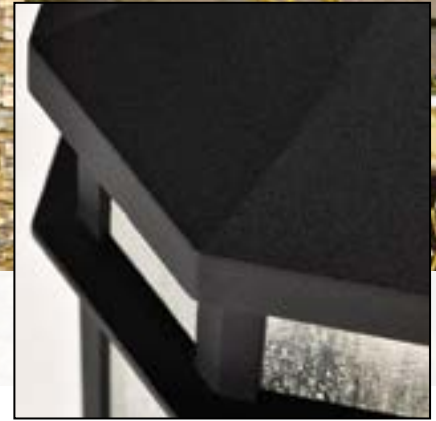

# RAIDEN

The Raiden collection boasts a traditional design yet is suited to today's contemporary lighting styles. The matte black pairs nicely with existing pieces, the ideal fixtures to add curb appeal and style your home's exterior landscape.

ITEM	DESCRIPTION	FINISH	NO. OF LIGHTS	LAMP TYPE	BASE	MAX WATTS	WIDTH	HEIGHT	EXT.	CERT. TYPE
60-5758	1 Lt. Post Lantern	Matte Black / Clear Seeded Glass	1	A19	Med.	100W	7.5"	17.875"	•	Wet
60-5759	1 Lt. Hanging Lantern	Matte Black / Clear Seeded Glass	1	A19	Med.	100W	7.5"	14.5"	•	Damp
60-5760	1 Lt. Wall Lantern	Matte Black / Clear Seeded Glass	1	A19	Med.	100W	7.5"	13.875"	8.75"	Wet

3' Chain: 25-508

Pier Mount Base: 25-504

Hanging Lantern: 12' of wire and 4' of chain supplied



60-5760 - 8" W



60-5759 - 8" W



60-5758 - 8" W

## FINISH



Matte Black  
Clear Seeded Glass



# LAKEVIEW

Carriage lighting evokes a sense of nostalgia and timeless elegance, perfectly embodied with the Lakeview Outdoor Collection. The clear seeded glass continues the eras past theme and combined with an aged bronze finish, completes the overall design. Illuminate your front door or patio to create instant curb appeal with this stylish series.

ITEM	DESCRIPTION	FINISH	NO. OF LIGHTS	LAMP TYPE	BASE	MAX WATTS	WIDTH	HEIGHT	EXT.	CERT. TYPE
60-6511	Med. Wall Lantern	Aged Bronze	1	T9	Med.	60W	9"	16.25"	10.25"	Wet
60-6512	Sm. Wall Lantern	Aged Bronze	1	T9	Med.	60W	7"	12.25"	8.25"	Wet
60-6513	Post Lantern	Aged Bronze	1	T9	Med.	60W	9"	8.25"	8.25"	Wet
60-6514	Hanging Lantern	Aged Bronze	1	T9	Med.	60W	9"	16.25"	•	Damp

Additional chain: (3') 25-5004

Pier Mount Base: 25-5008

60W T9 S2422 Vintage lamps included

Hanging Lantern: 12' of wire and 4' of chain supplied



60-6511 - 9" W (shown)



60-6514 - 9" W



60-6513 - 9" W

## FINISH



Aged Bronze Seeded Glass

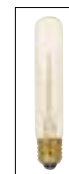

T9 Vintage lamps included



# JAMESPORT

Like many hamlets, the Jamesport Outdoor collection transcends conventional styles to suit many homes' architectural designs. Pouring light from all sides for optimal illumination, present your guests with inviting and welcoming illumination as they approach your home.

ITEM	DESCRIPTION	FINISH	NO. OF LIGHTS	LAMP TYPE	BASE	MAX WATTS	LENGTH	WIDTH	HEIGHT	EXT.	CERT. TYPE
60-5932	3 Lt. Post Lantern	Matte Black / Clear Glass	3	B10	E12	100W	7.5"	7.5"	15.25"	•	Wet
60-5933	3 Lt. Hanging Lantern	Matte Black / Clear Glass	3	B10	E12	100W	7.5"	7.5"	11.44"	•	Damp
60-5934	3 Lt. Sm. Wall Lantern	Matte Black / Clear Glass	3	B10	E12	100W	•	7.5"	11.11"	9.25"	Wet

3' Chain: 25-508

Pier Mount Base: 25-504

Hanging Lantern: 12' of wire and 4' of chain supplied



60-5934 - 8" W

## FINISH



Matte Black  
Clear Glass



60-5933 - 8" W



60-5932 - 8" W



# LANSING

The Lansing outdoor lanterns are a traditional lantern, with contemporary style. The textured black fixture is made of steel for a durable lantern designed to withstand harsh weather conditions. Impress your guests, and keep your family safe with Lansing.

ITEM	DESCRIPTION	FINISH	NO. OF LIGHTS	LAMP TYPE	BASE	MAX WATTS	WIDTH	HEIGHT	EXT.	CERT. TYPE
60-6401	Sm. Wall Lantern	Textured Black / Etched Opal Glass	1	A19	Med.	100W	7"	9.875"	7.75"	Wet
60-6402	Med. Wall Lantern	Textured Black / Etched Opal Glass	1	A19	Med.	100W	9"	11.375"	9.75"	Wet
60-6403	Lg. Wall Lantern	Textured Black / Etched Opal Glass	1	A19	Med.	100W	11"	13.375"	11.75"	Wet
60-6405	Hanging Lantern	Textured Black / Etched Opal Glass	1	A19	Med.	100W	11"	16.875"	•	Damp
60-6406	Post Lantern	Textured Black / Etched Opal Glass	1	A19	Med.	100W	11"	13.875"	•	Wet

Additional chain: (3') 25-6407

Pier Mount Base: 25-6406

Hanging Lantern: 12' of wire and 4' of chain supplied



60-6401 - 7" W



60-6402 - 9" W



60-6403 - 11" W

## FINISH



Textured Black  
Etched Opal Glass



60-6405 - 11" W



60-6406 - 11" W

# TOFINO

Tofino blends mission-craftsman design with today's modern style, ideal for complementing a variety of home exteriors, bring a glowing ambiance to light your evenings.

ITEM	DESCRIPTION	FINISH	NO. OF LIGHTS	LAMP TYPE	BASE	MAX WATTS	WIDTH	HEIGHT	EXT.	CERT. TYPE
60-6571	Sm. Wall Lantern	Textured Black	1	T9	Med.	60W	5.38"	11.25"	6.5"	Wet
60-6572	Med. Wall Lantern	Textured Black	1	T9	Med.	60W	6.38"	14.5"	7.38"	Wet
60-6573	Lg. Wall Lantern	Textured Black	1	T9	Med.	60W	7.38"	15.88"	8.5"	Wet
60-6574	Hanging Lantern	Textured Black	1	T9	Med.	60W	7.38"	16.38"	•	Damp
60-6575	Post Lantern	Textured Black	1	T9	Med.	60W	7.38"	17.75"	•	Wet

Additional chain: (3') 25-6407

Pier Mount Base: 25-6406

Hanging Lantern: 12' of wire and 4' of chain supplied



60-6571 - 5" W



60-6572 - 6" W



60-6573 - 7" W

## FINISH



Textured Black  
Clear Glass



60-6574 - 7" W



60-6575 - 7" W



# HURON

Enhance your home's exterior with the Huron Outdoor Collection that blends Traditional and Modern styles with ease. The classic handheld lantern style pays homage to times past with the included vintage bulb while the beautiful bronze finish and clear glass capture a modern feel and design. Illuminate your front door or garage to create instant curb appeal with this stylish series.

## FINISH



Aged Bronze  
Clear Glass

ITEM	DESCRIPTION	FINISH	NO. OF LIGHTS	LAMP TYPE	BASE	MAX WATTS	WIDTH	HEIGHT	EXT.	CERT. TYPE
60-6501	Med. Wall Lantern	Aged Bronze	1	T9	Med.	60W	8.25"	18"	9.25"	Wet
60-6502	Sm. Wall Lantern	Aged Bronze	1	T9	Med.	60W	7"	15.5"	8"	Wet
60-6503	Post Lantern	Aged Bronze	1	T9	Med.	60W	8.25"	20.875"	•	Wet
60-6504	Hanging Lantern	Aged Bronze	1	T9	Med.	60W	8.25"	18"	•	Damp

Additional chain: (3') 25-5004

Pier Mount Base: 25-5008

60W T9 S2422 Vintage lamps included

Hanging Lantern: 12' of wire and 4' of chain supplied



60-6504 - 8" W



60-6501 - 8" W (shown)



60-6503 - 8" W

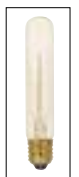

T9 Vintage lamps included



# BROADSTONE

With the Broadstone outdoor collection, every piece is a testament to the art of transition, creating a welcoming atmosphere that bridges the gap between traditional and contemporary living. As the sun sets and the fixtures come to life, let your outdoor spaces tell a story of timeless sophistication.



ITEM	DESCRIPTION	FINISH	NO. OF LIGHTS	LAMP TYPE	BASE	MAX WATTS	WIDTH	HEIGHT	EXT.	CERT TYPE
60-8111	Sm. Wall Lantern	Matte Black/Clear Seeded Glass	1	A19	Medium	40W	5.375"	12.36"	6.88"	Wet
60-8112	Med. Wall Lantern	Matte Black/Clear Seeded Glass	2	Type B	Candelabra	40W	7"	15.63"	9"	Wet
60-8113	Lg. Wall Lantern	Matte Black/Clear Seeded Glass	2	Type B	Candelabra	40W	8.625"	19.38"	11"	Wet
60-8114	Post Top Lantern	Matte Black/Clear Seeded Glass	2	Type B	Candelabra	40W	8.625"	21.70"	•	Wet
60-8115	Hanging Lantern	Matte Black/Clear Seeded Glass	2	Type B	Candelabra	40W	8.625"	18.88"	•	Damp

Additional Chain: (3') 25-508

Pier Mount Base: 25-504

Hanging Lantern: 12' of wire and 4' of chain supplied



60-8112- 7" W (shown)



60-8115 - 9" W



60-8114 - 9" W

## FINISH



Matte Black  
Clear Seeded Glass



# WILTON

Crafted with precision, the Wilton outdoor collection elevates your home's exterior with transitional allure and a hint to coastal charm. Whether you are greeting guests or seeking a peaceful welcome upon arriving home, Wilton combines function, form, and design beautifully.

ITEM	DESCRIPTION	FINISH	NO. OF LIGHTS	LAMP TYPE	BASE	MAX WATTS	WIDTH	HEIGHT	EXT.	CERT TYPE
60-8101	Sm. Wall Lantern	Matte Black/Clear Seeded Glass	1	T9	Medium	60W	5"	11.625"	6.875"	Wet
60-8102	Med. Wall Lantern	Matte Black/Clear Seeded Glass	1	ST19	Medium	100W	6.5"	15.125"	8.375"	Wet
60-8103	Lg. Wall Lantern	Matte Black/Clear Seeded Glass	1	ST19	Medium	100W	8.25"	19.75"	10.375"	Wet
60-8104	Hanging Lantern	Matte Black/Clear Seeded Glass	1	ST19	Medium	100W	8.25"	19.75"	•	Damp
60-8105	Post Top Lantern	Matte Black/Clear Seeded Glass	1	ST19	Medium	100W	8.25"	22.625"	•	Wet

Additional Chain: (3') 25-508

Pier Mount Base: 25-504

Hanging Lantern: 12' of wire and 4' of chain supplied



60-8102- 7" W (shown)



60-8104 - 8" W



60-8105 - 8" W

## FINISH



Matte Black  
Clear Seeded Glass



# HOPEWELL

Bring modern curb appeal with Hopewell, a finely constructed collection that casts an inviting ambiance. Greet all who arrive with this stylish series that embodies a classic structure that is beautifully designed.

## FINISH



Matte Black  
Clear Seeded Glass

ITEM	DESCRIPTION	FINISH	NO. OF LIGHTS	LAMP TYPE	BASE	MAX WATTS	WIDTH	HEIGHT	EXT.	CERT TYPE
60-6591	Sm. Wall Lantern	Matte Black/Clear Seeded Glass	1	A19	Med.	60W	6"	12"	7"	Wet
60-6592	Med. Wall Lantern	Matte Black/Clear Seeded Glass	1	A19	Med.	60W	7.5"	14.75"	8.5"	Wet
60-6593	Lg. Wall Lantern	Matte Black/Clear Seeded Glass	1	A19	Med.	60W	9"	17.13"	10"	Wet
60-6594	Hanging Lantern	Matte Black/Clear Seeded Glass	1	A19	Med.	60W	9"	17.63"	•	Damp
60-6595	Post Lantern	Matte Black/Clear Seeded Glass	1	A19	Med.	60W	9"	17.63"	•	Wet

Additional chain: (3') 25-462

Pier Mount Base for post: 25-476

Hanging Lantern: 12' of wire and 4' of chain supplied



60-6594 - 9" W



60-6591 - 6" W



60-6592 - 6" W



60-6595 - 9" W



60-6593 - 9" W



# HALIFAX

Satco's Halifax two-light medium lantern sconce brings a touch of simplicity to your outdoor spaces, blending modern sophistication with a subtle nod to nautical charm. With a warm, and welcoming glow, it creates a striking silhouette that captivates the eye. The perfect balance between bold design and timeless elegance.

ITEM	DESCRIPTION	FINISH	NO. OF LIGHTS	LAMP TYPE	BASE	MAX WATTS	LENGTH	WIDTH	HEIGHT	EXT.	CERT. TYPE
60-6581	Sm. Wall Lantern	Matte Black/Clear Glass	1	ST19	Med.	60W	•	6"	10.25"	6.75"	Wet
60-6582	Med. Wall Lantern	Matte Black/Clear Glass	2	T9	Cand.	60W	•	8"	13.5"	8.5"	Wet
60-6583	Lg. Wall Lantern	Matte Black/Clear Glass	4	T9	Cand.	60W	•	9.5"	15.75"	10"	Wet
60-6584	Hanging Lantern	Matte Black/Clear Glass	4	T9	Cand.	60W	9.5"	9.5"	17.75"	•	Damp
60-6585	Post Lantern	Matte Black/Clear Glass	4	T9	Cand.	60W	9.5"	9.5"	16.125"	•	Wet

Additional chain: (3') 25-462

Pier Mount Base: 25-476

Hanging Lantern: 12' of wire and 4' of chain supplied



60-6581 - 6" W



60-6582 - 8" W



60-6583 - 10" W

## FINISH



Matte Black  
Clear Glass



60-6584 - 10" W



60-6585 - 10" W



# CORNING

Understated elegance with timeless appeal, Corning outdoor fixtures features a carriage-inspired design with a touch of sophistication. Versatile and refined, this series seamlessly blends with a wide range of home exteriors.



ITEM	DESCRIPTION	FINISH	NO. OF LIGHTS	LAMP TYPE	BASE	MAX WATTS	LENGTH	WIDTH	HEIGHT	EXT.	CERT. TYPE
60-7371	Med. Wall Lantern	Matte Black/Clear Glass	1	A19	Med.	100W	•	5.93"	15.61"	7.33"	Wet
60-7372	Lg. Wall Lantern	Matte Black/Clear Glass	1	A19	Med.	100W	•	8"	20"	9.63"	Wet



60-7371 - 6" W



60-7372 - 8" W

## FINISH



Matte Black  
Clear Glass



# SULLIVAN

The Sullivan collection combines clean lines and minimal details in one flexible design, modern yet simple. Perfect for lighting the way with a stylish and versatile appeal, bringing stunning illumination to your homes exterior.

ITEM	DESCRIPTION	FINISH	NO. OF LIGHTS	LAMP TYPE	BASE	MAX WATTS	LENGTH	WIDTH	HEIGHT	EXT.	CERT. TYPE
60-7375	Med. Wall Lantern	Matte Black / Clear Seeded Glass	1	A19	Med.	100W	•	7.5"	12.5"	6.25"	Wet
60-7376	Lg. Wall Lantern	Matte Black / Clear Seeded Glass	1	A19	Med.	100W	•	9.25"	15.5"	8"	Wet
60-7377	Hanging lantern	Matte Black / Clear Seeded Glass	1	A19	Med.	100W	6.63"	9"	16.63"	•	Damp
60-7378	Post Fixture Lantern	Matte Black / Clear Seeded Glass	1	A19	Med.	100W	6.63"	9"	17.13"	•	Wet

3' Chain: 25-508

Pier Mount Base: 25-504

Hanging Lantern: 12' of wire and 4' of chain supplied



60-7376 - 9" W (shown)



60-7377 - 9" W



60-7378 - 9" W

## FINISH



Matte Black  
Clear Seeded Glass



# LUCA

Bring contemporary elegance to your outdoor spaces with the Luca Outdoor Series. Inspired by the clean lines of urban townhouse style, these lanterns blend timeless design with modern sensibility.

## FINISH



Sand Black  
Clear Bevel Glass

ITEM	DESCRIPTION	FINISH	NO. OF LIGHTS	LAMP TYPE	BASE	MAX WATTS	WIDTH	HEIGHT	EXT.	CERT. TYPE
60-8510	Sm. Outdoor Lantern	Sand Black w/ Clear Bevel Glass	1	A19	Med.	100W	5.75"	13"	7.38"	Wet
60-8511	Med. Outdoor Lantern	Sand Black w/ Clear Bevel Glass	1	A19	Med.	100W	5.75"	16.5"	7.38"	Wet
60-8512	Lg. Outdoor Lantern	Sand Black w/ Clear Bevel Glass	1	A19	Med.	100W	7"	20"	8.75"	Wet
60-8513	Outdoor Post Lantern	Sand Black w/ Clear Bevel Glass	1	A19	Med.	100W	7"	22.75"	•	Wet
60-8514	Hanging Pendant	Sand Black w/ Clear Bevel Glass	1	A19	Med.	100W	7"	22.75"	•	Damp



60-8514 - 23" Ht



60-8510 - 6" W (shown)



60-8513 - 23" Ht

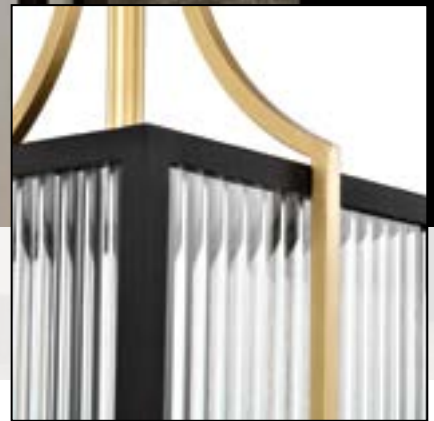

# HOLDEN

Elevate your home's exterior with the timeless grandeur with the Holden Outdoor Collection. Designed with an estate-style sophistication, these lanterns are a bold tribute to refined living.

## FINISH



Gold/Black  
Clear Ribbed Glass



60-8502 - 9" W (shown)

ITEM	DESCRIPTION	FINISH	NO. OF LIGHTS	LAMP TYPE	BASE	MAX WATTS	WIDTH	HEIGHT	EXT.	CERT. TYPE
60-8501	Sm. Outdoor Lantern	Gold / Black / Clear Ribbed Glass	1	A19	Med.	100W	6.5"	11.13"	6.88"	Wet
60-8502	Med. Outdoor Lantern	Gold / Black / Clear Ribbed Glass	1	A19	Med.	100W	8.5"	14.5"	6.88"	Wet
60-8503	Lg. Outdoor Lantern	Gold / Black / Clear Ribbed Glass	1	A19	Med.	60W	8.5"	21.75"	8.88"	Wet
60-8504	Outdoor Post Lantern	Gold / Black / Clear Ribbed Glass	1	A19	Med.	100W	8.5"	24.38"	•	Wet
60-8505	Hanging Pendant	Gold / Black / Clear Ribbed Glass	1	A19	Med.	100W	8.5"	23.25"	•	Damp



60-8505 - 9" W



60-8503 - 9" W



60-8504 - 9" W



# EXHIBIT

With great attention to detail and superb styling, the Exhibit wall lanterns are the ideal solution for your outdoor lighting needs. Add a touch of modern charm to your exterior landscape with these stylish fixtures.

## FINISH



Matte Black  
Clear Beveled Glass

ITEM	DESCRIPTION	FINISH	NO. OF LIGHTS	LAMP TYPE	BASE	MAX WATTS	WIDTH	HEIGHT	EXT.	CERT. TYPE
60-7543	Sm. Wall Lantern	Matte Black/Clear Beveled Glass	1	T9	Med.	60W	6"	14"	3.75"	Wet
60-7544	Med. Wall Lantern	Matte Black/Clear Beveled Glass	1	T9	Med.	60W	7"	17"	4.5"	Wet
60-7545	Lg. Wall Lantern	Matte Black/Clear Beveled Glass	1	T9	Med.	60W	8"	20"	5.13"	Wet



60-7543 - 6" W



60-7544 - 7" W



60-7545 - 8" W

# HOMESTEAD

The Homestead collection seamlessly blends classic charm with modern design, providing a unique contrast with a wood finish and metal frame. With its versatile design and clean lines, this series complements a variety of home styles, from ranch to modern.

ITEM	DESCRIPTION	FINISH	NO. OF LIGHTS	LAMP TYPE	BASE	WATTS	WIDTH	HEIGHT	EXT.	CERT. TYPE
60-7540	Sm. Wall Lantern	Matte Black & Wood Finish/ Clear Seeded Glass	1	T9	Med.	60W	5.38"	10.63"	6"	Wet
60-7541	Med. Wall Lantern	Matte Black & Wood Finish/ Clear Seeded Glass	1	T9	Med.	60W	5.38"	16"	6"	Wet
60-7542	Lg. Wall Lantern	Matte Black & Wood Finish/ Clear Seeded Glass	1	T9	Med.	60W	6.25"	18.75"	6.88"	Wet



60-7540 - 5" W

## FINISH



Matte Black & Wood Finish/  
Clear Seeded Glass



60-7541 - 5" W



60-7542 - 6" W



# DREXEL

The Drexel outdoor lanterns features a craftsman style approach to exterior lighting. The frosted seeded glass provides old world charm, and the stone black finish on the body showcases the design. Drexel is the finest in exterior lighting sure to bring stunning curb appeal to your home.

ITEM	DESCRIPTION	FINISH	NO. OF LIGHTS	LAMP TYPE	BASE	MAX WATTS	WIDTH	HEIGHT	EXT.	CERT. TYPE
60-5601	Sm. Wall Lantern	Stone Black/Frosted Seed Glass	1	A19	Med.	60W	7"	10.5"	8.5"	Wet
60-5602	Med. Wall Lantern	Stone Black/Frosted Seed Glass	1	A19	Med.	100W	9"	14"	10.5"	Wet
60-5603	Lg. Wall Lantern	Stone Black/Frosted Seed Glass	1	A19	Med.	100W	10"	15.5"	11.5"	Damp
60-5604	Hanging Lantern	Stone Black/Frosted Seed Glass	1	A19	Med.	100W	10"	16"	•	Damp
60-5605	Post Lantern	Stone Black/Frosted Seed Glass	1	A19	Med.	100W	10"	18"	•	Wet
60-5606	Flush Lantern	Stone Black/Frosted Seed Glass	2	A19	Med.	60W	11"	5.5"	•	Wet

Additional chain: (3') 25-5604

Pier Mount Base: 25-5605

Hanging Lantern: 12' of wire and 4' of chain supplied



60-5601 - 7" W



60-5602 - 9" W



60-5603 - 10" W

## FINISH



Stone Black/  
Frosted Seed Glass



60-5604 - 10" W



60-5606 - 11" W



60-5605 - 10" W



# WINGATE

Classic charm and age old whimsy perfectly describes the Wingate 60-5621 small outdoor wall lantern. The curving arm mimics the carriage lights of yesteryear, and the heavily seeded clear glass continues the theme of time gone by, adorned with a simple X pattern. Finished in a textured black, Wingate exudes charisma and is sure to bring timeless curb appeal to your home's exterior.

ITEM	DESCRIPTION	FINISH	NO. OF LIGHTS	LAMP TYPE	BASE	MAX WATTS	WIDTH	HEIGHT	EXT.	CERT. TYPE
60-5621	Sm. Wall Lantern	Textured Black/Clear Seeded Glass	1	A19	Med.	60W	6.88"	17.88"	9.25"	Wet
60-5622	Med. Wall Lantern	Textured Black/Clear Seeded Glass	1	A19	Med.	100W	9.88"	25.25"	13.13"	Wet
60-5623	Lg. Wall Lantern	Textured Black/Clear Seeded Glass	3	B11	Cand.	100W	11.63"	30.88"	15.50"	Wet
60-5624	Hanging Lantern	Textured Black/Clear Seeded Glass	1	A19	Med.	100W	9.88"	18.50"	•	Damp
60-5625	Post Lantern	Textured Black/Clear Seeded Glass	1	A19	Med.	100W	9.88"	23.00"	•	Wet
60-5626	Flush Lantern	Textured Black/Clear Seeded Glass	2	A19	Med.	60W	11.25"	5.13"	•	Wet

Additional chain: (3') 25-1071

Pier Mount Base: 25-1200

Hanging Lantern: 12' of wire and 4' of chain supplied



60-5621 - 7" W



60-5622 - 10" W



60-5623 - 12" W

## FINISH



Textured Black  
Clear Seeded Glass



60-5624 - 10" W



60-5626 - 11" W



60-5625 - 10" W



# HOWELL

Nuvo's Howell outdoor lanterns are an understated lighting solution for outside the home. Illuminate stoops, porches, decks, and windows, with this bronze lantern featuring copper accents. A single ST19 bulb sits behind the clear seeded glass of this charming small outdoor lantern. Contemporary and elegant, Howell adds style to the exterior of any home.

ITEM	DESCRIPTION	FINISH	NO. OF LIGHTS	LAMP TYPE	BASE	MAX WATTS	WIDTH	HEIGHT	EXT.	CERT. TYPE
60-5831	Sm. Wall Lantern	Bronze/Copper & Seeded Glass	1	A19	Med.	60W	5.25"	11.13"	5.38"	Wet
60-5832	Med. Wall Lantern	Bronze/Copper & Seeded Glass	1	A19	Med.	60W	7.00"	14.13"	7.13"	Wet
60-5833	Lg. Wall Lantern	Bronze/Copper & Seeded Glass	1	A19	Med.	60W	8.75"	17.13"	8.75"	Wet
60-5834	Flush Lantern	Bronze/Copper & Seeded Glass	2	A19	Med.	60W	12.00"	4.13"	•	Wet
60-5835	Post Lantern	Bronze/Copper & Seeded Glass	1	A19	Med.	60W	8.75"	19.38"	•	Wet
60-5836	Hanging Lantern	Bronze/Copper & Seeded Glass	1	A19	Med.	60W	8.75"	17.13"	•	Damp

Additional chain: (3') 25-4225

Pier Mount Base: 25-5615

60W ST19 S2423 Vintage lamps included

Hanging Lantern: 12' of wire and 4' of chain supplied



60-5831 - 5" W



60-5832 - 7" W



60-5833 - 9" W

## FINISH



Bronze/  
Copper Accents  
& Seeded Glass



60-5836 - 9" W



60-5834 - 12" W



60-5835 - 9" W



ST19 Vintage lamps included



# VEGA

Nuvo's Vega outdoor wall fixtures are an understated lighting solution for outside the home. Illuminate stoops, porches, pathways, and windows with this classic bronze, wall mounted fixture. A single A19 bulb is featured behind the clear seeded glass of this charming, metal fixture. Contemporary and elegant, Vega adds style to the exterior of any home.

## FINISH



Classic Bronze/  
Clear Seeded Glass



60-5611 - 7" W



60-5612 - 9" W



60-5613 - 11" W

ITEM	DESCRIPTION	FINISH	NO. OF LIGHTS	LAMP TYPE	BASE	MAX WATTS	WIDTH	HEIGHT	EXT.	CERT. TYPE
60-5611	Sm. Wall Lantern	Classic Bronze/Clear Seeded Glass	1	A19	Med.	60W	6.5"	9.75"	8.25"	Wet
60-5612	Med. Wall Lantern	Classic Bronze/Clear Seeded Glass	1	A19	Med.	100W	9"	13.5"	11.25"	Wet
60-5613	Lg. Wall Lantern	Classic Bronze/Clear Seeded Glass	1	A19	Med.	100W	11"	16.5"	13.5"	Wet
60-5614	Hanging Lantern	Classic Bronze/Clear Seeded Glass	1	A19	Med.	100W	9"	12"	•	Damp
60-5615	Post Lantern	Classic Bronze/Clear Seeded Glass	1	A19	Med.	100W	9"	13.25"	•	Wet
60-5616	Flush Lantern	Classic Bronze/Clear Seeded Glass	2	A19	Med.	600W	11.25"	5.125"	•	Wet

Additional chain: (3') 25-5614

Pier Mount Base: 25-5615

Hanging Lantern: 12' of wire and 4' of chain supplied



60-5614 - 9" W



60-5616 - 11" W



60-5615 - 9" W



# MORRIS

Capture the charm of countryside living with the Morris Outdoor Series. Designed with a classic barn light silhouette and accented by industrial details, these fixtures bring farmhouse chic to your exterior spaces.

## FINISH OPTIONS



Black



Black Arm  
White Shade



Burnished Bronze

ITEM	DESCRIPTION	FINISH	NO. OF LIGHTS	LAMP TYPE	BASE	MAX WATTS	WIDTH	HEIGHT	EXT.	CERT. TYPE
60-8550	Sm. Outdoor Lantern	Black	1	A19	Med.	100W	10"	11.63"	11.38"	Wet
60-8560	Sm. Outdoor Lantern	Black Arm White Shade	1	A19	Med.	100W	10"	11.63"	11.38"	Wet
60-8570	Sm. Outdoor Lantern	Burnished Bronze	1	A19	Med.	100W	10"	11.63"	11.38"	Wet
60-8551	Med. Outdoor Lantern	Black	1	A19	Med.	100W	12"	13.38"	13.5	Wet
60-8561	Med. Outdoor Lantern	Black Arm White Shade	1	A19	Med.	100W	12"	13.38"	13.5	Wet
60-8571	Med. Outdoor Lantern	Burnished Bronze	1	A19	Med.	100W	12"	13.38"	13.5	Wet



60-8550 - 10" W  
Black



60-8560 - 10" W  
Black Arm  
White Shade



60-8570 - 10" W  
Burnished Bronze



60-8551 - 12" W  
Black



60-8561 - 12" W  
Black Arm  
White Shade



60-8571 - 12" W  
Burnished Bronze



# RIDGE

The Ridge Outdoor Series brings cottage-style warmth and timeless beauty to your outdoor spaces. Perfect for your porch, garden, or entryway, they enhance your home with classic style re-imagined for today's aesthetic.

## FINISH OPTIONS



White /  
Clear Seeded Glass



Bronze /  
Clear Seeded Glass



Black /  
Clear Seeded Glass

ITEM	DESCRIPTION	FINISH	LIGHT SOURCE	MAX WATTS	WIDTH	HEIGHT	EXT	CERT TYPE
60-8520	Sm. Outdoor Lantern	White / Clear Seeded Glass	A19	40W	8"	8.13"	9"	Wet
60-8530	Sm. Outdoor Lantern	Bronze / Clear Seeded Glass	A19	40W	8"	8.13"	9"	Wet
60-8540	Sm. Outdoor Lantern	Black / Clear Seeded Glass	A19	40W	8"	8.13"	9"	Wet
60-8521	Med. Outdoor Lantern	White / Clear Seeded Glass	A19	40W	10"	8.88"	11"	Wet
60-8531	Med. Outdoor Lantern	Bronze / Clear Seeded Glass	A19	40W	10"	8.88"	11"	Wet
60-8541	Med. Outdoor Lantern	Black / Clear Seeded Glass	A19	40W	10"	8.88"	11"	Wet



60-8520 - 8" W  
White



60-8530 - 8" W  
Bronze



60-8540 - 8" W  
Black



60-8521 - 10" W  
White



60-8531 - 10" W  
Bronze



60-8541 - 10" W  
Black



# NEWBRIDGE

With a maritime aesthetic, the Newbridge collection feels right at home in a coastal setting, yet features a broad appeal for various design styles. For curb appeal at its finest, Newbridge fits the bill.

ITEM	DESCRIPTION	FINISH	NO. OF LIGHTS	LAMP TYPE	BASE	MAX WATTS	WIDTH	HEIGHT	EXT.	CERT. TYPE
60-7001	1 Lt. Sm. Wall	Gloss Black / Silver and Textured Black	1	A19	Med.	60W	9.75"	12.375"	13.5"	Wet
60-7002	1 Lt. Lg. Wall	Gloss Black / Silver and Textured Black	1	A19	Med.	60W	12"	14.125"	19.25"	Wet
60-7003	1 Lt. Sm. Pendant	Gloss Black / Silver and Textured Black	1	A19	Med.	60W	9.75"	8.25"	•	Damp
60-7004	1 Lt. Lg. Pendant	Gloss Black / Silver and Textured Black	1	A19	Med.	60W	12"	8.75"	•	Damp
60-7011	1 Lt. Sm. Wall	Dark Bronze / Gold Reflector	1	A19	Med.	60W	9.75"	12.375"	13.5"	Wet
60-7012	1 Lt. Lg. Wall	Dark Bronze / Gold Reflector	1	A19	Med.	60W	12"	14.125"	19.25"	Wet
60-7013	1 Lt. Sm. Pendant	Dark Bronze / Gold Reflector	1	A19	Med.	60W	9.75"	8.25"	•	Damp
60-7014	1 Lt. Lg. Pendant	Dark Bronze / Gold Reflector	1	A19	Med.	60W	12"	8.75"	•	Damp
60-7021	1 Lt. Sm. Wall	Gloss White / Textured Black Reflector	1	A19	Med.	60W	9.75"	12.375"	13.5"	Wet
60-7022	1 Lt. Lg. Wall	Gloss White / Textured Black Reflector	1	A19	Med.	60W	12"	14.125"	19.25"	Wet
60-7023	1 Lt. Sm. Pendant	Gloss White / Textured Black Reflector	1	A19	Med.	60W	9.75"	8.25"	•	Damp
60-7024	1 Lt. Lg. Pendant	Gloss White / Textured Black Reflector	1	A19	Med.	60W	12"	8.75"	•	Damp

Additional Stems: Gloss Black (6") 25-3043, (12") 25-3044

Additional Stems: Dark Bronze (6") 25-3045, (12") 25-3046

(2) x 6" Stems and (2) x 12" Stems Included

Pendants: 12' of wire supplied.



60-7001 - 10" W (shown)  
Gloss Black



60-7022 - 12" W (shown)  
Gloss White

## FINISH OPTIONS



Gloss Black /  
Silver and Textured  
Black



Dark Bronze /  
Gold Reflector



Gloss White  
Textured Black  
White Reflector



60-7023 - 10" W (shown)  
Gloss White



60-7014 - 12" W (shown)  
Dark Bronze



# INDIE

The Indie walls sconces combine grace and confidence in a refined, minimalist design. Elegant, and sophisticated, with a touch of modern elegance, they are the perfect accent to elevate your home decor.

## FINISH



Textured Black  
Clear Seeded Glass

ITEM	DESCRIPTION	FINISH	NO. OF LIGHTS	LAMP TYPE	BASE	MAX WATTS	WIDTH	HEIGHT	EXT.	CERT. TYPE
60-6578	1 Lt. Lg. Wall Sconce	Textured Black Clear Seeded Glass	1	A19	Med.	60W	6"	17"	5.75"	Wet
60-6579	1 Lt. Sm. Wall Sconce	Textured Black Clear Seeded Glass	1	A19	Med.	60W	5"	13"	5.5"	Wet

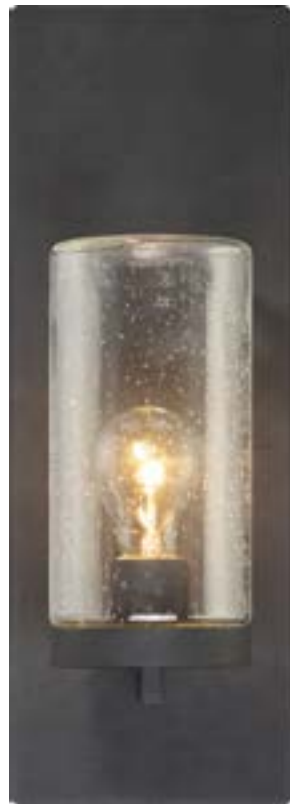

60-6578 - 6" W  
Textured Black



60-6579 - 5" W  
Textured Black



# OUTDOOR CLASSICS

## MAKE A LASTING IMPRESSION

Designed to offer both style and function, these lights transform any exterior space into a welcoming, sophisticated environment. From charming lanterns to sleek post lights and durable wall sconces, our selection is perfect for any outdoor setting.

Crafted with quality and durability in mind, each fixture is built to withstand the elements while providing reliable illumination. These outdoor lights not only brighten patios, pathways, and gardens, but they also add character and a sense of warmth to your home's exterior, making it feel more inviting and stylish. With SATCO|NUVO's classic outdoor lighting, outdoor spaces will shine with timeless appeal.



# OUTDOOR | ADAMS

## 60-4901

White / Frosted Glass

ADAMS WALL LANTERN / ARM UP

(1) 100W A19 max. / Medium base  
Wet location rated

Dimensions: Width 6.13", Height 18.25",  
Ext. 6.88", Top to Outlet 13.75"



## 60-4904

White / Frosted Glass

ADAMS WALL LANTERN / ARM DOWN

(1) 100W A19 max. / Medium base  
Wet location rated

Dimensions: Width 6.13", Height 13.75",  
Ext. 6.88", Top to Outlet 9.63"



## 60-4902

Rustic Bronze / Frosted Glass

ADAMS WALL LANTERN / ARM UP

(1) 100W A19 max. / Medium base  
Wet location rated

Dimensions: Width 6.13", Height 18.25",  
Ext. 6.88", Top to Outlet 13.75"



## 60-4905

Rustic Bronze / Frosted Glass

ADAMS WALL LANTERN / ARM DOWN

(1) 100W A19 max. / Medium base  
Wet location rated

Dimensions: Width 6.13", Height 13.75",  
Ext. 6.88", Top to Outlet 9.63"



## 60-4903

Textured Black / Frosted Glass

ADAMS WALL LANTERN / ARM UP

(1) 100W A19 max. / Medium base  
Wet location rated

Dimensions: Width 6.13", Height 18.25",  
Ext. 6.88", Top to Outlet 13.75"



## 60-4906

Textured Black / Frosted Glass

ADAMS WALL LANTERN / ARM DOWN

(1) 100W A19 max. / Medium base  
Wet location rated

Dimensions: Width 6.13", Height 13.75",  
Ext. 6.88", Top to Outlet 9.63"



## LANTERNS

### 60-4911

White / Frosted Glass

#### ADAMS HANGING LANTERN

(1) 100W A19 max. / Medium base

Damp location rated

Dimensions: Width 6.13", Height 15.75",  
Chain 48", Wire 12'

#### ACCESSORIES:

**25-1166** 3' Section of White chain



### 60-4907

White / Frosted Glass

#### ADAMS POST LANTERN

(1) 100W A19 max. / Medium base

Wet location rated

Dimensions: Width 6.13", Height 18.75"  
Fitter 3"

#### ACCESSORIES:

**25-1205** White pier mount base



### 60-4912

Rustic Bronze / Frosted Glass

#### ADAMS HANGING LANTERN

(1) 100W A19 max. / Medium base

Damp location rated

Dimensions: Width 6.13", Height 15.75",  
Chain 48", Wire 12'

#### ACCESSORIES:

**25-4998** 3' Section of Rustic Bronze chain



### 60-4908

Rustic Bronze / Frosted Glass

#### ADAMS POST LANTERN

(1) 100W A19 max. / Medium base

Wet location rated

Dimensions: Width 6.13", Height 18.25"  
Fitter 3"

#### ACCESSORIES:

**25-4908** Rustic Bronze pier mount base



### 60-4913

Textured Black / Frosted Glass

#### ADAMS HANGING LANTERN

(1) 100W A19 max. / Medium base

Damp location rated

Dimensions: Width 6.13", Height 15.75",  
Chain 48", Wire 12'

#### ACCESSORIES:

**25-1071** 3' Section of Textured Black chain



### 60-4909

Textured Black / Frosted Glass

#### ADAMS POST LANTERN

(1) 100W A19 max. / Medium base

Wet location rated

Dimensions: Width 6.13", Height 18.25"  
Fitter 3"

#### ACCESSORIES:

**25-1200** Textured Black pier mount base



# OUTDOOR | BANYAN

## 60-4924

White / Clear Water Glass

WALL LANTERN ARM UP

(1) 100W A19 max. / Medium base  
Wet location rated  
Dimensions: Width 6.13", Height 17",  
Ext. 8", Top to Outlet 11.75"



## 60-4921

White / Clear Water Glass

WALL LANTERN ARM DOWN

(1) 100W A19 max. / Medium base  
Wet location rated  
Dimensions: Width 6.13", Height 12.25",  
Ext. 8", Top to Outlet 9.25"



## 60-4925

Rustic Bronze / Clear Water Glass

WALL LANTERN ARM UP

(1) 100W A19 max. / Medium base  
Wet location rated  
Dimensions: Width 6.13", Height 17",  
Ext. 8", Top to Outlet 11.75"



## 60-4922

Rustic Bronze / Clear Water Glass

WALL LANTERN ARM DOWN

(1) 100W A19 max. / Medium base  
Wet location rated  
Dimensions: Width 6.13", Height 12.25",  
Ext. 8", Top to Outlet 9.25"



## 60-4926

Textured Black / Clear Water Glass

WALL LANTERN ARM UP

(1) 100W A19 max. / Medium base  
Wet location rated  
Dimensions: Width 6.13", Height 17",  
Ext. 8", Top to Outlet 11.75"



## 60-4923

Textured Black / Clear Water Glass

WALL LANTERN ARM DOWN

(1) 100W A19 max. / Medium base  
Wet location rated  
Dimensions: Width 6.13", Height 12.25",  
Ext. 8", Top to Outlet 9.25"



## LANTERNS

### 60-4931

White / Clear Water Glass

#### HANGING LANTERN

(1) 100W A19 max. / Medium base

Damp location rated

Dimensions: Width 6.13", Height 10.75",  
Chain 48", Wire 12'

#### ACCESSORIES:

**25-1166** 3' Section of White chain



### 60-4927

White / Clear Water Glass

#### POST LANTERN

(1) 100W A19 max. / Medium base

Wet location rated

Dimensions: Width 6.13", Height 17.25"  
Fitter 3"

#### ACCESSORIES:

**25-1205** White pier mount base



### 60-4932

Rustic Bronze / Clear Water Glass

#### HANGING LANTERN

(1) 100W A19 max. / Medium base

Damp location rated

Dimensions: Width 6.13", Height 10.75",  
Chain 48", Wire 12'

#### ACCESSORIES:

**25-4998** 3' Section of Rustic Bronze chain



### 60-4928

Rustic Bronze / Clear Water Glass

#### POST LANTERN

(1) 100W A19 max. / Medium base

Wet location rated

Dimensions: Width 6.13", Height 17.25"  
Fitter 3"

#### ACCESSORIES:

**25-4908** Rustic Bronze pier mount base



### 60-4933

Textured Black / Clear Water Glass

#### HANGING LANTERN

(1) 100W A19 max. / Medium base

Damp location rated

Dimensions: Width 6.13", Height 10.75",  
Chain 48", Wire 12'

#### ACCESSORIES:

**25-1071** 3' Section of Textured Black chain



### 60-4929

Textured Black / Clear Water Glass

#### POST LANTERN

(1) 100W A19 max. / Medium base

Wet location rated

Dimensions: Width 6.13", Height 17.25"  
Fitter 3"

#### ACCESSORIES:

**25-1200** Textured Black pier mount base



# OUTDOOR | BOXWOOD

## 60-4967

White / Clear Beveled Glass

BOXWOOD WALL LANTERN  
ARM DOWN

(3) 60W Type B max. / Candelabra base  
Wet location rated  
Dimensions: Width 13", Height 26.25",  
Ext. 12.5", Top to Outlet 11"



## 60-4971

White / Clear Beveled Glass

BOXWOOD WALL LANTERN / ARM UP

(1) 100W A19 max. / Med. base  
Wet location rated  
Dimensions: Width 8", Height 22",  
Ext. 7.88", Top to Outlet 16"



## 60-4968

Rustic Bronze / Clear Beveled Glass

BOXWOOD WALL LANTERN  
ARM DOWN

(3) 60W Type B max. / Candelabra base  
Wet location rated  
Dimensions: Width 13", Height 26.25",  
Ext. 12.5", Top to Outlet 11"



## 60-4972

Rustic Bronze / Clear Beveled Glass

BOXWOOD WALL LANTERN / ARM UP

(1) 100W A19 max. / Med. base  
Wet location rated  
Dimensions: Width 8", Height 22",  
Ext. 7.88", Top to Outlet 16"



## 60-4969

Textured Black / Clear Beveled Glass

BOXWOOD WALL LANTERN  
ARM DOWN

(3) 60W Type B max. / Candelabra base  
Wet location rated  
Dimensions: Width 13", Height 26.25",  
Ext. 12.5", Top to Outlet 11"



## 60-4973

Textured Black / Clear Beveled Glass

BOXWOOD WALL LANTERN / ARM UP

(1) 100W A19 max. / Med. base  
Wet location rated  
Dimensions: Width 8", Height 22",  
Ext. 7.88", Top to Outlet 16"



## LANTERNS

### 60-4964

White / Clear Beveled Glass

BOXWOOD WALL LANTERN  
ARM DOWN

1) 100W A19 max. / Medium base  
Wet location rated  
Dimensions: Width 9.88", Height 19",  
Ext. 9", Top to Outlet 7.25"



### 60-4961

White / Clear Beveled Glass

BOXWOOD WALL LANTERN  
ARM DOWN

(1) 100W A19 max. / Med. base  
Wet location rated  
Dimensions: Width 8", Height 15.75",  
Ext. 7.88", Top to Outlet 5.75"



### 60-4965

Rustic Bronze / Clear Beveled Glass

BOXWOOD WALL LANTERN  
ARM DOWN

1) 100W A19 max. / Medium base  
Wet location rated  
Dimensions: Width 9.88", Height 19",  
Ext. 9", Top to Outlet 7.25"



### 60-4962

Rustic Bronze / Clear Beveled Glass

BOXWOOD WALL LANTERN  
ARM DOWN

(1) 100W A19 max. / Med. base  
Wet location rated  
Dimensions: Width 8", Height 15.75",  
Ext. 7.88", Top to Outlet 5.75"



### 60-4966

Textured Black / Clear Beveled Glass

BOXWOOD WALL LANTERN  
ARM DOWN

1) 100W A19 max. / Medium base  
Wet location rated  
Dimensions: Width 9.875", Height 19",  
Ext. 9", Top to Outlet 7.25"



### 60-4963

Textured Black / Clear Beveled Glass

BOXWOOD WALL LANTERN  
ARM DOWN

(1) 100W A19 max. / Med. base  
Wet location rated  
Dimensions: Width 8", Height 15.75",  
Ext. 7.88", Top to Outlet 5.75"



# OUTDOOR | BOXWOOD

## LANTERNS

### 60-4977

White / Clear Beveled Glass

BOXWOOD HANGING LANTERN

(1) 100W A19 max. / Medium base  
Damp location rated  
Dimensions: Width 8", Height 13.75",  
Chain 48", Wire 12'

ACCESSORIES:

**25-1166** 3' Section of White chain



### 60-4974

White / Clear Beveled Glass

BOXWOOD POST LANTERN

(1) 100W A19 max. / Medium base  
Wet location rated  
Dimensions: Width 8", Height 19.25"  
Fitter 3"

ACCESSORIES:

**25-1205** White pier mount base



### 60-4978

Rustic Bronze / Clear Beveled Glass

BOXWOOD HANGING LANTERN

(1) 100W A19 max. / Medium base  
Damp location rated  
Dimensions: Width 8", Height 13.75",  
Chain 48", Wire 12'

ACCESSORIES:

**25-4998** 3' Section of Rustic Bronze chain



### 60-4975

Rustic Bronze / Clear Beveled Glass

BOXWOOD POST LANTERN

(1) 100W A19 max. / Medium base  
Wet location rated  
Dimensions: Width 8", Height 19.25"  
Fitter 3"

ACCESSORIES:

**25-4908** Rustic Bronze pier mount base



### 60-4979

Textured Black / Clear Beveled Glass

BOXWOOD HANGING LANTERN

(1) 100W A19 max. / Medium base  
Damp location rated  
Dimensions: Width 8", Height 13.75",  
Chain 48", Wire 12'

ACCESSORIES:

**25-1071** 3' Section of Textured Black chain



### 60-4976

Textured Black / Clear Beveled Glass

BOXWOOD POST LANTERN

(1) 100W A19 max. / Medium base  
Wet location rated  
Dimensions: Width 8", Height 19.25"  
Fitter 3"

ACCESSORIES:

**25-1200** Textured Black pier mount base



# OUTDOOR | COVE NECK

## LANTERNS

### 60-4951

White / Clear Seeded Glass

COVE NECK WALL LANTERN  
ARM DOWN

(1) 100W A19 max. / Medium base  
Wet location rated

Dimensions: Width 7", Height 11.75",  
Ext. 9.5", Top to Outlet 5.25"



### 60-4957

White / Clear Seeded Glass

COVE NECK WALL LANTERN  
ARM DOWN

(1) 100W A19 max. / Medium base  
Wet location rated

Dimensions: Width 9", Height 14",  
Ext. 11.5", Top to Outlet 6.25"



### 60-4952

Rustic Bronze / Clear Seeded Glass

COVE NECK WALL LANTERN  
ARM DOWN

(1) 100W A19 max. / Medium base  
Wet location rated

Dimensions: Width 7", Height 11.75",  
Ext. 9.5", Top to Outlet 5.25"



### 60-4958

Rustic Bronze / Clear Seeded Glass

COVE NECK WALL LANTERN  
ARM DOWN

(1) 100W A19 max. / Medium base  
Wet location rated

Dimensions: Width 9", Height 14",  
Ext. 11.5", Top to Outlet 6.25"



### 60-4953

Textured Black / Clear Seeded Glass

COVE NECK WALL LANTERN  
ARM DOWN

(1) 100W A19 max. / Medium base  
Wet location rated

Dimensions: Width 7", Height 11.75",  
Ext. 9.5", Top to Outlet 5.25"



### 60-4959

Textured Black / Clear Beveled Glass

COVE NECK WALL LANTERN  
ARM DOWN

(1) 100W A19 max. / Medium base  
Wet location rated

Dimensions: Width 9", Height 14",  
Ext. 11.5", Top to Outlet 6.25"



# OUTDOOR | COVE NECK

## 60-4954

White / Clear Seeded Glass

COVE NECK HANGING LANTERN

(1) 100W A19 max. / Medium base

Damp location rated

Dimensions: Width 7", Height 12"

ACCESSORIES:

**25-1166** 3' Section of White chain



## 60-4955

Rustic Bronze / Clear Seeded Glass

COVE NECK HANGING LANTERN

(1) 100W A19 max. / Medium base

Damp location rated

Dimensions: Width 7", Height 12"

ACCESSORIES:

**25-4998** 3' Section of Rustic Bronze chain



## 60-4956

Textured Black / Clear Seeded Glass

COVE NECK HANGING LANTERN

(1) 100W A19 max. / Medium base

Damp location rated

Dimensions: Width 7", Height 12"

ACCESSORIES:

**25-1071** 3' Section of Textured Black chain



**60-5951**

White / Clear Seeded Glass

COVE NECK OUTDOOR  
LARGE POST

(1) 100W A19 max. / Medium base  
Wet location rated  
Dimensions: Width 9", Height 16.14"  
Fitter 3"

ACCESSORIES:

**25-521** White pier mount base



**60-5954**

White / Clear Seeded Glass

COVE NECK OUTDOOR  
SMALL POST

(1) 100W A19 max. / Medium base  
Wet location rated  
Dimensions: Width 7.11", Height 13.78"  
Fitter 3"

ACCESSORIES:

**25-521** White pier mount base



**60-5952**

Rustic Bronze / Clear Seeded Glass

COVE NECK OUTDOOR  
LARGE POST

(1) 100W A19 max. / Medium base  
Wet location rated  
Dimensions: Width 9", Height 16.14"  
Fitter 3"

ACCESSORIES:

**25-522** Rustic Bronze pier mount base



**60-5955**

Rustic Bronze / Clear Seeded Glass

COVE NECK OUTDOOR  
SMALL POST

(1) 100W A19 max. / Medium base  
Wet location rated  
Dimensions: Width 7.11", Height 13.78"  
Fitter 3"

ACCESSORIES:

**25-522** Rustic Bronze pier mount base



**60-5953**

Textured Black / Clear Seeded Glass

COVE NECK OUTDOOR  
LARGE POST

(1) 100W A19 max. / Medium base  
Wet location rated  
Dimensions: Width 9", Height 16.14"  
Fitter 3"

ACCESSORIES:

**25-523** Textured Black pier mount base



**60-5956**

Textured Black / Clear Seeded Glass

COVE NECK OUTDOOR  
SMALL POST

((1) 100W A19 max. / Medium base  
Wet location rated  
Dimensions: Width 7.11", Height 13.78"  
Fitter 3"

ACCESSORIES:

**25-523** Textured Black pier mount base



# OUTDOOR | CENTRAL PARK

## 60-885

White / Clear Beveled Panels

CENTRAL PARK WALL LANTERN  
ARM UP

(1) 100W A19 max. / Med. base  
Wet location rated

Dimensions: Width 6", Height 20",  
Ext. 9.75", Top to Outlet 13"



## 60-888

White / Clear Beveled Panels

CENTRAL PARK WALL LANTERN  
ARM UP

(3) 60W Type B max. / Candelabra base  
Wet location rated

Dimensions: Width 7.38", Height 22.75",  
Ext. 11.5", Top to Outlet 15"



## 60-886

Rustic Bronze / Clear Beveled Panels

CENTRAL PARK WALL LANTERN  
ARM UP

(1) 100W A19 max. / Med. base  
Wet location rated

Dimensions: Width 6", Height 20",  
Ext. 9.75", Top to Outlet 13"



## 60-889

Rustic Bronze / Clear Beveled Panels

CENTRAL PARK WALL LANTERN  
ARM UP

(3) 60W Type B max. / Candelabra base  
Wet location rated

Dimensions: Width 7.38", Height 22.75",  
Ext. 11.5", Top to Outlet 15"



## 60-887

Textured Black / Clear Beveled Panels

CENTRAL PARK WALL LANTERN  
ARM UP

(1) 100W A19 max. / Med. base  
Wet location rated

Dimensions: Width 6.65", Height 20.5",  
Ext. 9.75", Top to Outlet 13"



## 60-890

Textured Black / Clear Beveled Panels

CENTRAL PARK WALL LANTERN  
ARM UP

(3) 60W Type B max. / Candelabra base  
Wet location rated

Dimensions: Width 7.38", Height 22.75",  
Ext. 11.5", Top to Outlet 15"



**60-891**

White / Clear Beveled Panels

CENTRAL PARK WALL LANTERN  
ARM DOWN

(3) 60W Type B max. / Candelabra base  
Wet location rated

Dimensions: Width 7.38", Height 22.75",  
Ext. 11.5", Top to Outlet 4"



**60-892**

Rustic Bronze / Clear Beveled Panels

CENTRAL PARK WALL LANTERN  
ARM DOWN

(3) 60W Type B max. / Candelabra base  
Wet location rated

Dimensions: Width 7.38", Height 22.75",  
Ext. 11.5", Top to Outlet 4"



**60-893**

Textured Black / Clear Beveled Panels

CENTRAL PARK WALL LANTERN  
ARM DOWN

(3) 60W Type B max. / Candelabra base  
Wet location rated

Dimensions: Width 7.38", Height 22.75",  
Ext. 11.5", Top to Outlet 4"



# OUTDOOR | CENTRAL PARK

## 60-894

White / Clear Beveled Panels

### CENTRAL PARK HANGING LANTERN

(3) 60W Type B max. / Candelabra base  
Damp location rated  
Dimensions: Width 7.38",  
Height 20", Chain 48", Wire 12'

#### ACCESSORIES:

**25-1166** 3' Section of White chain



## 60-895

Old Bronze / Clear Beveled Panels

### CENTRAL PARK HANGING LANTERN

(3) 60W Type B max. / Candelabra base  
Damp location rated  
Dimensions: Width 7.38",  
Height 20", Chain 48", Wire 12'

#### ACCESSORIES:

**25-1067** 3' Section of Old Bronze chain



## 60-896

Textured Black / Clear Beveled Panels

### CENTRAL PARK HANGING LANTERN

(3) 60W Type B max. / Candelabra base  
Damp location rated  
Dimensions: Width 7.38",  
Height 20", Chain 48", Wire 12'

#### ACCESSORIES:

**25-1071** 3' Section of Textured Black chain



**60-897**

White / Clear Beveled Panels

CENTRAL PARK POST LANTERN

(3) 60W Type B max. / Candelabra base

Wet location rated

Dimensions: Width 7.38", Height 21"

Fitter 3"

ACCESSORIES:

**25-1205** White pier mount base



**60-898**

Old Bronze / Clear Beveled Panels

CENTRAL PARK POST LANTERN

(3) 60W Type B max. / Candelabra base

Wet location rated

Dimensions: Width 7.38", Height 21"

Fitter 3"

ACCESSORIES:

**25-1203** Old Bronze pier mount base



**60-899**

Textured Black / Clear Beveled Panels

CENTRAL PARK POST LANTERN

(3) 60W Type B max. / Candelabra base

Wet location rated

Dimensions: Width 7.38", Height 21"

Fitter 3"

ACCESSORIES:

**25-1200** Textured Black pier mount base



# OUTDOOR | CORNERSTONE

## 60-985

White / Clear Seeded Glass

CORNERSTONE WALL LANTERN  
ARM UP

Long & Short Tail Provided  
(1) 60W A19 max. / Medium base  
Wet location rated  
Dimensions: Width 7",  
Height w/short tail 12", w/long tail 18",  
Ext. 9.25", Top to Outlet 11"



## 60-988

White / Clear Seeded Glass

CORNERSTONE WALL LANTERN  
ARM DOWN

(1) 60W A19 max. / Medium base  
Wet location rated  
Dimensions: Width 7", Height 13",  
Ext. 9.25", Top to Outlet 4"



## 60-986

Rustic Bronze / Clear Seeded Glass

CORNERSTONE WALL LANTERN  
ARM UP

Long & Short Tail Provided  
(1) 60W A19 max. / Medium base  
Wet location rated  
Dimensions: Width 7",  
Height w/short tail 12", w/long tail 18",  
Ext. 9.25", Top to Outlet 11"



## 60-989

Rustic Bronze / Clear Seeded Glass

CORNERSTONE WALL LANTERN  
ARM DOWN

(1) 60W A19 max. / Medium base  
Wet location rated  
Dimensions: Width 7", Height 13",  
Ext. 9.25", Top to Outlet 4"



## 60-987

Textured Black / Clear Seeded Glass

CORNERSTONE WALL LANTERN  
ARM UP

Long & Short Tail Provided  
(1) 60W A19 max. / Medium base  
Wet location rated  
Dimensions: Width 7",  
Height w/short tail 12", w/long tail 18",  
Ext. 9.25", Top to Outlet 11"



## 60-990

Textured Black / Clear Seeded Glass

CORNERSTONE WALL LANTERN  
ARM DOWN

(1) 60W A19 max. / Medium base  
Wet location rated  
Dimensions: Width 7", Height 13",  
Ext. 9.25", Top to Outlet 4"



## LANTERNS

### 60-991

White / Clear Seeded Glass

#### CORNERSTONE HANGING LANTERN

(1) 60W A19 max. / Medium base  
Damp location rated  
Dimensions: Width 7",  
Height 12.63", Chain 48", Wire 12'

ACCESSORIES:

**25-1166** 3' Section of White chain



### 60-994

White / Clear Seeded Glass

#### CORNERSTONE POST LANTERN

(1) 60W A19 max. / Medium base  
Wet location rated  
Dimensions: Width 7", Height 14.25"  
Fitter 3"

ACCESSORIES:

**25-1205** White pier mount base



### 60-992

Old Bronze / Clear Seeded Glass

#### CORNERSTONE HANGING LANTERN

(1) 60W A19 max. / Medium base  
Damp location rated  
Dimensions: Width 7",  
Height 12.63", Chain 48", Wire 12'

ACCESSORIES:

**25-1067** 3' Section of Old Bronze chain



### 60-995

Old Bronze / Clear Seeded Glass

#### CORNERSTONE POST LANTERN

(1) 60W A19 max. / Medium base  
Wet location rated  
Dimensions: Width 7", Height 14.25"  
Fitter 3"

ACCESSORIES:

**25-1203** Old Bronze pier mount base



### 60-993

Textured Black / Clear Seeded Glass

#### CORNERSTONE HANGING LANTERN

(1) 60W A19 max. / Medium base  
Damp location rated  
Dimensions: Width 7",  
Height 12.63", Chain 48", Wire 12'

ACCESSORIES:

**25-1071** 3' Section of Textured Black chain



### 60-996

Textured Black / Clear Seeded Glass

#### CORNERSTONE POST LANTERN

(1) 60W A19 max. / Medium base  
Wet location rated  
Dimensions: Width 7", Height 14.25"  
Fitter 3"

ACCESSORIES:

**25-1200** Textured Black pier mount base



# OUTDOOR | BRITON

## 60-540

White / Clear Seeded Glass

BRITON WALL LANTERN  
ARM UP

Long & Short Tail Provided  
(1) 60W A19 max. / Medium base  
Wet location rated  
Dimensions: Width 6",  
Height w/short tail 15", w/long tail 18",  
Ext. 6.13", Top to Outlet 12"



## 60-541

Old Bronze / Clear Seeded Glass

BRITON WALL LANTERN  
ARM UP

Long & Short Tail Provided  
(1) 60W A19 max. / Medium base  
Wet location rated  
Height w/short tail 15", w/long tail 18",  
Ext. 6.13", Top to Outlet 12"



## 60-542

Textured Black / Clear Seeded Glass

BRITON WALL LANTERN  
ARM UP

Long & Short Tail Provided  
(1) 60W A19 max. / Medium base  
Wet location rated  
Height w/short tail 15", w/long tail 18",  
Ext. 6.13", Top to Outlet 12"



## LANTERNS

### 60-546

White / Clear Glass

#### BRITON POST LANTERN

(1) 60W A19 max. / Medium base  
Damp location rated  
Dimensions: Width 6", Height 14",  
Fitter 3"

#### ACCESSORIES:

**25-1205** White pier mount base



### 60-487

White / Clear Glass

#### BRITON HANGING LANTERN

(1) 60W A19 max. / Medium base  
Damp location rated  
Dimensions: Width 6",  
Height 9.5", Chain 48", Wire 12'

#### ACCESSORIES:

**25-1166** 3' Section of White chain



### 60-547

Old Bronze / Clear Glass

#### BRITON POST LANTERN

(1) 60W A19 max. / Medium base  
Damp location rated  
Dimensions: Width 6", Height 14",  
Fitter 3

#### ACCESSORIES:

**25-1203** Old Bronze pier mount base



### 60-488

Old Bronze / Clear Glass

#### BRITON HANGING LANTERN

(1) 60W A19 max. / Medium base  
Damp location rated  
Dimensions: Width 6",  
Height 9.5", Chain 48", Wire 12'

#### ACCESSORIES:

**25-1067** 3' Section of White chain



### 60-548

Textured Black / Clear Glass

#### BRITON POST LANTERN

(1) 60W A19 max. / Medium base  
Damp location rated  
Dimensions: Width 6", Height 14",  
Fitter 3

#### ACCESSORIES:

**25-1200** Textured Black pier mount base



### 60-489

Textured Black / Clear Glass

#### BRITON HANGING LANTERN

(1) 60W A19 max. / Medium base  
Damp location rated  
Dimensions: Width 6",  
Height 9.5", Chain 48", Wire 12'

#### ACCESSORIES:

**25-1071** 3' Section of White chain



# OUTDOOR | ONION & PIPER

## 60-630

White / Clear Seeded Glass

### ONION WALL LANTERN

(1) 60W A19 max. / Medium base  
Wet location rated

Dimensions: Width 6", Height 10.63",  
Ext. 8", Top to Outlet 4.5"



## 60-633

White / Clear Seeded Glass

### PIPER WALL LANTERN

(1) 60W A19 max. / Medium base  
Wet location rated

Dimensions: Width 5", Height 10.63",  
Ext. 7", Top to Outlet 6"



## 60-631

Old Bronze / Clear Seeded Glass

### ONION WALL LANTERN

(1) 60W A19 max. / Medium base  
Wet location rated

Dimensions: Width 6", Height 10.63",  
Ext. 8", Top to Outlet 4.5"



## 60-634

Old Bronze / Clear Seeded Glass

### PIPER WALL LANTERN

(1) 60W A19 max. / Medium base  
Wet location rated

Dimensions: Width 5", Height 10.63",  
Ext. 7", Top to Outlet 6"



## 60-632

Textured Black / Clear Seeded Glass

### ONION WALL LANTERN

(1) 60W A19 max. / Medium base  
Wet location rated

Dimensions: Width 6", Height 10.63",  
Ext. 8", Top to Outlet 4.5"



## 60-635

Textured Black / Clear Seeded Glass

### PIPER WALL LANTERN

(1) 60W A19 max. / Medium base  
Wet location rated

Dimensions: Width 5", Height 10.63",  
Ext. 7", Top to Outlet 6"



# OUTDOOR | CUBE & HOOD LANTERNS

## 60-636

White / Clear Beveled Glass

### CUBE WALL LANTERN

(1) 60W A19 max. / Medium base

Wet location rated

Dimensions: Width 4.38", Height 8.63",

Ext. 6.13", Top to Outlet 3"



## 60-639

White / Satin Frosted Glass

### HOOD WALL LANTERN

(1) 60W A19 max. / Medium base

Wet location rated

Dimensions: Width 6", Height 8.88",

Ext. 6.88", Top to Outlet 3.5"



## 60-637

Old Bronze / Clear Beveled Glass

### CUBE WALL LANTERN

(1) 60W A19 max. / Medium base

Wet location rated

Dimensions: Width 4.375", Height 8.63",

Ext. 6.13", Top to Outlet 3"



## 60-640

Old Bronze / Satin Frosted Glass

### HOOD WALL LANTERN

(1) 60W A19 max. / Medium base

Wet location rated

Dimensions: Width 6", Height 8.88",

Ext. 6.88", Top to Outlet 3.5"



## 60-638

Textured Black / Clear Beveled Glass

### CUBE WALL LANTERN

(1) 60W A19 max. / Medium base

Wet location rated

Dimensions: Width 4.38", Height 8.63",

Ext. 6.13", Top to Outlet 3"



## 60-641

Textured Black / Satin Frosted Glass

### HOOD WALL LANTERN

(1) 60W A19 max. / Medium base

Wet location rated

Dimensions: Width 6", Height 8.88",

Ext. 6.88", Top to Outlet 3.5"



# OUTDOOR

## 60-537 White

DIE CAST CAGE LANTERN

Linen Acrylic Lens

(1) 60W A19 max. / Medium base  
Wet location rated  
Dimensions: Width 7.75",  
Height 9.75", Ext. 4.25"



## 60-534 White

DIE CAST CEILING "SPIDER" CAGE

Glass Lens

(1) 60W A19 max. / Medium base  
Wet location rated  
Dimensions: Width 11.38", Height 5"



## 60-538 Old Bronze

DIE CAST CAGE LANTERN

Linen Acrylic Lens

(1) 60W A19 max. / Medium base  
Wet location rated  
Dimensions: Width 7.75",  
Height 9.75", Ext. 4.25"



## 60-535 Old Bronze

DIE CAST CEILING "SPIDER" CAGE

Glass Lens

(1) 60W A19 max. / Medium base  
Wet location rated  
Dimensions: Width 11.38", Height 5"



## 60-539 Textured Black

DIE CAST CAGE LANTERN

Linen Acrylic Lens

(1) 60W A19 max. / Medium base  
Wet location rated  
Dimensions: Width 7.75",  
Height 9.75", Ext. 4.25"



## 60-536 Textured Black

DIE CAST CEILING "SPIDER" CAGE

Glass Lens

(1) 60W A19 max. / Medium base  
Wet location rated  
Dimensions: Width 11.38", Height 5"



**60-520**  
Semi White Gloss

DIE CAST ROUND HOOD BULKHEAD

(1) 60W A19 max. / Medium base  
Wet location rated  
Dimensions: Dia. 10", Ext. 5"



**60-521**  
Architectural Bronze

DIE CAST ROUND HOOD BULKHEAD

(1) 60W A19 max. / Medium base  
Wet location rated  
Dimensions: Dia. 10", Ext. 5"



**60-522**  
Semi White Gloss

DIE CAST OVAL HOOD BULKHEAD

(1) 60W A19 max. / Medium base  
Wet location rated  
Dimensions: Width 10",  
Height 6.13", Ext. 5.5"



**60-523**  
Architectural Bronze

DIE CAST OVAL HOOD BULKHEAD

(1) 60W A19 max. / Medium base  
Wet location rated  
Dimensions: Width 10",  
Height 6.13", Ext. 5.5"



**60-524**  
Semi White Gloss

DIE CAST OVAL CAGE BULKHEAD

(1) 60W A19 max. / Medium base  
Wet location rated  
Dimensions: Width 6.13",  
Height 10", Ext. 5.5"



**60-525**  
Architectural Bronze

DIE CAST OVAL CAGE BULKHEAD

(1) 60W A19 max. / Medium base  
Wet location rated  
Dimensions: Width 6.13",  
Height 10", Ext. 5.5"



# OUTDOOR



**77-859**  
Black

ROUND CAGE  
Polysynthetic Body & Lens  
(1) 60W A19 max. / Medium base  
Wet location rated  
Dimensions: Dia. 6.13", Height 10", Ext. 5.5"

---



**77-861**  
White

ROUND CAGE  
Polysynthetic Body & Lens  
(1) 60W A19 max. / Medium base  
Wet location rated  
Dimensions: Dia. 6.13", Height 10", Ext. 5.5"



**77-857**  
Black

OVAL CAGE  
Polysynthetic Body & Lens

(1) 60W A19 max. / Medium base  
Wet location rated

Dimensions: Width 10", Height 5", Ext. 4"

---



**77-858**  
White

OVAL CAGE  
Polysynthetic Body & Lens

(1) 60W A19 max. / Medium base  
Wet location rated

Dimensions: Width 10", Height 5", Ext. 4"

# OUTDOOR

## 60-530

Semi Gloss White

DIE CAST RECTANGLE  
BULKHEAD

- (1) 60W A19 max. / Medium base
- Wet location rated
- Dimensions: Width 6.5",  
Height 10", Ext. 4.88"



## 60-531

Architectural Bronze

DIE CAST RECTANGLE  
BULKHEAD

- (1) 60W A19 max. / Medium base
- Wet location rated
- Dimensions: Width 6.5",  
Height 10", Ext. 4.88"



## 60-526

Semi Gloss White

DIE CAST LARGE OVAL  
BULKHEAD

- (1) 60W A19 max. / Medium base
- Wet location rated
- Dimensions: Width 9",  
Height 11", Ext. 4.38"



## 60-527

Architectural Bronze

DIE CAST LARGE OVAL  
BULKHEAD

- (1) 60W A19 max. / Medium base
- Wet location rated
- Dimensions: Width 9",  
Height 11", Ext. 4.38"



## 60-516

Semi Gloss White

DIE CAST OBLONG ROUND  
BULKHEAD

- (1) 60W A19 max. / Medium base
- Wet location rated
- Dimensions: Width 9.13",  
Height 10.5", Ext. 4.5"



## 60-517

Architectural Bronze

DIE CAST OBLONG ROUND  
BULKHEAD

- (1) 60W A19 max. / Medium base
- Wet location rated
- Dimensions: Width 9.13",  
Height 10.5", Ext. 4.5"



## BULKHEADS

### 60-532

Semi White Gloss

DIE CAST RECTANGLE CAGE

- (1) 60W A19 max. / Medium base  
Dimensions: Width 6.5",  
Height 10", Ext. 4.88"



### 60-533

Architectural Bronze

DIE CAST RECTANGLE CAGE

- (1) 60W A19 max. / Medium base  
Wet location rated  
Dimensions: Width 6.5",  
Height 10", Ext. 4.88"



### 60-528

Semi White Gloss

DIE CAST LARGE OVAL CAGE

- (1) 60W A19 max. / Medium base  
Wet location rated  
Dimensions: Width 8.5",  
Height 12.5", Ext. 5"



### 60-529

Architectural Bronze

DIE CAST LARGE OVAL CAGE

- (1) 60W A19 max. / Medium base  
Wet location rated  
Dimensions: Width 8.5",  
Height 12.5", Ext. 5"



### 60-518

Semi White Gloss

DIE CAST ROUND CAGE

- (1) 60W A19 max. / Medium base  
Wet location rated  
Dimensions: Dia. 10", Ext. 5"



### 60-519

Architectural Bronze

DIE CAST ROUND CAGE

- (1) 60W A19 max. / Medium base  
Wet location rated  
Dimensions: Dia. 10", Ext. 5"



# OUTDOOR

## 76-618

White Frosted Glass

LARGE DIE-CAST INDUSTRIAL STYLE  
Ceiling Mount

(1) 200W A19 max. / Med. base  
Wet location rated

Dimensions: Height 11", Width 5.5"



## 76-616

White Frosted Glass

SMALL DIE-CAST INDUSTRIAL STYLE  
Ceiling Mount

(1) 100W A19 max. / Med. base  
Wet location rated

Dimensions: Height 9.38", Width 4.25"



## 76-626

Metallic Silver / Frosted Glass

LARGE DIE-CAST INDUSTRIAL STYLE  
Ceiling Mount

(1) 200W A19 max. / Med. base  
Wet location rated

Dimensions: Height 11", Width 5.5"



## 76-624

Metallic Silver / Frosted Glass

SMALL DIE-CAST INDUSTRIAL STYLE  
Ceiling Mount

(1) 100W A19 max. / Med. base  
Wet location rated

Dimensions: Height 9.38", Width 4.25"



## 76-627

Old Bronze / Frosted Glass

LARGE DIE-CAST INDUSTRIAL STYLE  
Ceiling Mount

(1) 200W A19 max. / Med. base  
Wet location rated

Dimensions: Height 11", Width 5.5"



## 76-625

Old Bronze / Frosted Glass

SMALL DIE-CAST INDUSTRIAL STYLE  
Ceiling Mount

(1) 100W A19 max. / Med. base  
Wet location rated

Dimensions: Height 9.38", Width 4.25"



## INDUSTRIAL | COMMERCIAL FIXTURES

### 76-617

White Frosted Glass

LARGE DIE-CAST INDUSTRIAL STYLE  
Wall Mount

(1) 300W A19 max. / Med. base  
Wet location rated  
Dimensions: Height 11",  
Width 5.5", Ext. 6.38"

ACCESSORIES:

**76-650** White Die-cast junction box



### 76-615

White Frosted Glass

SMALL DIE-CAST INDUSTRIAL STYLE  
Wall Mount

(1) 150W A19 max. / Med. base  
Wet location rated  
Dimensions: Height 9.38",  
Width 4.25", Ext. 5.38"

ACCESSORIES:

**76-650** White Die-cast junction box



### 76-622

Metallic Silver / Frosted Glass

LARGE DIE-CAST INDUSTRIAL STYLE  
Wall Mount

(1) 300W A19 max. / Med. base  
Wet location rated  
Dimensions: Height 11",  
Width 5.5", Ext. 6.38"

ACCESSORIES:

**76-651** Metallic Silver Die-cast junction box



### 76-620

Metallic Silver / Frosted Glass

SMALL DIE-CAST INDUSTRIAL STYLE  
Wall Mount

(1) 150W A19 max. / Med. base  
Wet location rated  
Dimensions: Height 9.38",  
Width 4.25", Ext. 5.38"

ACCESSORIES:

**76-651** Metallic Silver Die-cast junction box



### 76-623

Old Bronze / Frosted Glass

LARGE DIE-CAST INDUSTRIAL STYLE  
Wall Mount

(1) 300W A19 max. / Med. base  
Wet location rated  
Dimensions: Height 11",  
Width 5.5", Ext. 6.38"

ACCESSORIES:

**76-652** Old Bronze Die-cast junction box



### 76-621

Old Bronze / Frosted Glass

SMALL DIE-CAST INDUSTRIAL STYLE  
Wall Mount

(1) 150W A19 max. / Med. base  
Wet location rated  
Dimensions: Height 9.38",  
Width 4.25", Ext. 5.38"

ACCESSORIES:

**76-652** Old Bronze Die-cast junction box



# OUTDOOR

## CARPORT FLUSH MOUNTS

METAL FRAME  
 (2) 60W A19 max. / Medium base  
 Wet location rated  
 Dimensions: Width 9.25", Height 5"



60-470  
 White w/  
 Textured Frosted  
 Glass



60-471  
 Polished Brass w/  
 Textured Frosted  
 Glass



60-472  
 Old Bronze w/  
 Textured Frosted  
 Glass



60-473  
 Black w/  
 Textured Frosted  
 Glass

## CARPORT FLUSH MOUNTS

SMALL POLY FRAME  
 (1) 60W A19 max. / Medium base  
 Wet location rated  
 Dimensions: Width 8.25", Height 4.75"



77-835  
 White w/  
 Frosted Acrylic



77-863  
 Black w/  
 Frosted Acrylic

## CARPORT FLUSH MOUNTS

LARGE POLY FRAME  
 (2) 60W A19 max. / Medium base  
 Wet location rated  
 Dimensions: Width 10.25", Height 5.5"



77-879  
 White w/  
 Frosted Acrylic



77-891  
 Black w/  
 Frosted Acrylic

## UTILITY WALL MOUNT-GLOBE

(1) 100W A19 max. / Medium base  
 Wet location rated  
 Dimensions: Width 6",  
 Height 7.25", Ext. 7"



77-531  
 White w/  
 White Glass



77-139  
 Satin Aluminum w/  
 White Glass



77-141  
 Bronze w/  
 White Glass



77-140  
 Black w/  
 White Glass

## CARPORT FLUSH MOUNTS | UTILITY WALL & CEILING MOUNTS

### UTILITY CEILING MOUNT-GLOBE

(1) 60W A19 max. / Medium base  
Wet location rated  
Dimensions: Dia. 6", Height 7.25"



77-532  
White w/  
White Glass



77-152  
Satin Aluminum w/  
White Glass



77-153  
Bronze w/  
White Glass



77-157  
Black w/  
White Glass

### UTILITY CEILING MOUNT-CYLINDER

(1) 60W A19 max. / Medium base  
Wet location rated  
Dimensions: Dia. 4.25", Height 8"



77-533  
White w/  
White Glass



77-155  
Satin Aluminum w/  
White Glass



77-156  
Bronze w/  
White Glass



77-154  
Black w/  
White Glass

### UTILITY WALL MOUNT-CYLINDER

(1) 100W A19 max. / Medium base  
Wet location rated  
Dimensions: Width 4.75", Height 8", Ext. 6"



77-530  
White w/  
White Glass



77-136  
Satin Aluminum w/  
White Glass



77-138  
Bronze w/  
White Glass



77-137  
Black w/  
White Glass

# OUTDOOR

## PORCH WALL CLEAR MASON JAR

(1) 60W A19 max. / Medium base  
Wet location rated

Dimensions: Width 4", Height 8.5", Ext. 5.5"



77-119B  
Black w/  
Clear Ribbed Glass



77-995  
Antique Brass w/  
Clear Ribbed Glass



77-996  
Polished Glass w/  
Clear Ribbed Glass

## PORCH WALL FROSTED MASON JAR

(1) 60W A19 max. / Medium base  
Wet location rated

Dimensions: Width 4", Height 8.5", Ext. 5.5"



76-700  
Old Bronze w/  
Frosted Ribbed  
Glass



76-701  
Brushed Nickel w/  
Frosted Ribbed  
Glass



76-702  
Gloss White w/  
Frosted Ribbed  
Glass

## PORCH WALL WHITE GLASS GLOBE

(1) 60W A19 max. / Medium base  
Wet location rated

Dimensions: Width. 5.5", Height 8.5", Ext. 6"



76-703  
Old Bronze w/  
White Glass



76-704  
Gloss White w/  
White Glass



76-705  
Brushed Nickel w/  
White Glass



77-992  
Black w/  
White Glass

## PORCH WALL | WALL & POST LANTERNS

### POLY COACH WALL LANTERN

(1) 60W A19 max. / Medium base  
Wet location rated  
Dimensions: Width 7.75", Height 17", Ext. 8"  
Top to Outlet 12"



77-897  
White w/  
Acrylic Panels



77-896  
Black w/  
Acrylic Panels

### POLY COACH POST LANTERN

(1) 60W A19 max. / Medium base  
Wet location rated  
Dimensions: Width 7.75", Height 12.5",



77-899  
White w/  
Acrylic Panels



77-898  
Black w/  
Acrylic Panels

### POLY MANSARD WALL LANTERN

(1) 60W A19 max. / Medium base  
Wet location rated  
Dimensions: Width 8", Height 17.5", Ext. 8",  
Top to Outlet 12"



77-853  
White w/  
Textured Acrylic  
Panels



77-852  
Black w/  
Textured Acrylic  
Panels

# OUTDOOR

## DIE CAST ALUMINUM ONE LIGHT

PAR38 Floodlights  
(1) 150W PAR38 max. / Medium base  
Wet location rated  
Dimensions: Width 4.5", Ext. 8"



77-700 Black



77-702 Gray



77-487 White



77-494 Bronze

## DIE CAST ALUMINUM TWO LIGHT

PAR38 FLOODLIGHTS  
(2) 150W PAR38 max. / Medium base  
Wet location rated  
Dimensions: Width 15", Ext. 8"



77-701 Black



77-703 Gray



77-488 White



77-495 Bronze

## ADD ON MOTION SENSOR

Fits .5" Threaded Knockouts



76-500 White



76-501 Bronze

## LED RATED ADD ON MOTION SENSOR

Fits .5" Threaded Knockouts



86-500 White



86-501 Black

**2 LT. "QUICK MOUNT ADJUSTABLE  
PAR HOLDERS**

(2) 150W PAR38 max. Wet location rated  
Dimensions: Width 8.75", Ext. 3.25"



76-684 White | 76-685 Bronze

**1 LT. "QUICK MOUNT" ADJUSTABLE  
PAR HOLDERS**

(1) 150W PAR38 max. Wet location rated  
Dimensions: Dia. 5", Ext. 3.25"



76-683 Bronze

**2 LT. PAR FLOODLIGHT**

(2) 150W PAR38 max. Wet location rated  
Dimensions: Width 10", Height 4.75", Ext. 5"



76-522 White | 76-523 Bronze

**1 LT. PAR FLOODLIGHT**

(1) 150W PAR38 max. Wet location rated  
Dimensions: Width 4.5", Height 4.75", Ext. 5"



76-520 White | 76-521 Bronze

**2 LT. PAR FLOODLIGHT  
with Motion Sensor**

(2) 150W PAR38 max. Wet location rated  
Dimensions: Width 10", Height 4.75"  
Ext. 9.5"



76-502 White | 76-503 Bronze

**2 LT. PAR38 FLOODLIGHTS  
with Motion Sensor**

(2) 150W PAR38 max. Wet location rated  
Dimensions: Width 14", Height 5", Ext. 9.5"



76-530 White | 76-531 Bronze

# OUTDOOR

## PAR38 LANDSCAPE FLOODLIGHT

(1) 150W PAR38 max. Wet location rated  
Dimensions: Dia. 5.5", Length 12.5"



76-648 Dark Bronze

76-658 Antique Verdi

## PAR30 LANDSCAPE FLOODLIGHT

(1) 75W PAR30 (Longneck). Wet location rated  
Dimensions: Dia. 4.25", Length 11.5"



76-647 Dark Bronze

76-657 Antique Verdi

## PAR20 LANDSCAPE FLOODLIGHT

(1) 50W PAR20 max. Wet location rated  
Dimensions: Dia. 2.75", Length 6.25"



76-646  
Dark Bronze

76-656  
Antique Verdi

## PAR16 LANDSCAPE FLOODLIGHT

(1) 50W PAR16 max. Wet location rated  
Dimensions: Dia. 2.5", Length 5.5"



76-645  
Dark Bronze

76-655  
Antique Verdi

## 6W LED LANDSCAPE FLOODLIGHT (PAR16 SIZE)

640 Lumens, 3000K, 80+ CRI.  
Wet location rated  
Dimensions: Dia. 2.45", Length 5.5"

- 62-1200  
Bronze
- 62-1202  
Light Grey
- 62-1197  
Matte Black



62-1201  
Dark Gray (shown)

## 9W LED LANDSCAPE FLOODLIGHT (PAR20 SIZE)

900 Lumens, 3000K, 80+ CRI.  
Wet location rated  
Dimensions: Dia. 2.63", Length 6.25"

- 62-1203  
Dark Grey
- 62-1205  
Bronze
- 62-1198  
Matte Black



62-1204  
Light Gray (shown)

## 12W LED LANDSCAPE FLOODLIGHT (PAR30 SIZE)

900 Lumens, 3000K, 80+ CRI.  
Wet location rated  
Dimensions: Dia. 5.51", Length 12.2"

- 62-1207  
Dark Grey
- 62-1208  
Light Grey
- 62-1199  
Matte Black



62-1206  
Bronze (shown)

**THREE LOUVER SMALL HOOD**

(1) 100W A19 max. / Medium base  
Wet location rated  
Dimensions: Height 8.63", Dia. 6.13"



76-633 Old Bronze



77-324 Green

**TWO LOUVER SMALL HOOD**

(1) 75W A19 max. / Medium base  
Wet location rated  
Dimensions: Height 7.13", Dia. 6.13"



76-632 Old Bronze



77-323 Green

**THREE LOUVER LARGE HOOD**

(1) 100W A19 max. / Medium base.  
Wet location rated  
Dimensions: Height 8.63", Dia. 9.63"



76-637 Old Bronze



76-636 Green

**TWO LOUVER LARGE HOOD**

(1) 75W A19 max. / Medium base.  
Wet location rated  
Dimensions: Height 7.13", Dia. 9.63"



76-635 Old Bronze



76-634 Green

# OUTDOOR



60-673

60-674

76-665

76-666



60-675

60-676

76-667

76-668

## 1 AND 2 LIGHT DIE CAST MOUNTING PLATES

60-673 1 Light / Light Gray

60-674 2 Light / Light Gray

60-675 1 Light / Dark Gray

60-676 2 Light / Dark Gray

76-665 1 Light / Dark Bronze

76-666 2 Light / Dark Bronze

76-667 1 Light / Antique Verdi

76-668 2 Light / Antique Verdi



90-1278



90-1279



## 12" X .5" STEEL MOUNTING POST

90-1278 Green Finish

90-1279 Old Bronze Finish  
(Mounting Posts are threaded on both ends)

## 3" DIAMETER PVC MOUNTING POST

Dimensions: Height 18", Dia. 3"



60-678  
Dark Gray



60-680  
Light Gray



60-641  
Dark Bronze



## 2" DIAMETER PVC MOUNTING POST

Dimensions: Height 18", Diameter 2"



60-677  
Dark Gray



60-679  
Light Gray



76-638  
Green



76-639  
Old Bronze



76-640  
Dark Bronze



76-644  
Antique Verdi



**DIE CAST JUNCTION BOXES**

(can be added to industrial style wall mount fixtures)

Dimensions: Height 1.75", Dia. 4"



76-650  
White



76-651  
Metallic Silver



76-652  
Old Bronze

**6" SQUARE PIER MOUNT BASES**

With 3" Fitter



25-1200 Textured Black



25-1203 Old Bronze



25-1205 White



25-4908 Rustic Bronze

**NOT SHOWN**

25-5605 Stone Black | 25-5615 Classic Bronze

**INCANDESCENT TWIST LOCK HOLDERS**

MAXIMUM WATTAGES

10" Globes - 60 watt max.

12" to 14" Globes - 100 watt max.

16" Globes - 150 watt max.

77-693 4" White

77-969 5.5" White



# INDEX

25-1200	459	60-343	283	60-675	458	60-3162	282
25-1203	459	60-344	283	60-676	458	60-3163	282
25-1205	459	60-345	283	60-677	458	60-3164	282
25-4091	47	60-346	283	60-678	458	60-3165	283
25-4908	459	60-347	283	60-679	458	60-3166	283
25-5605	459	60-356	256	60-680	458	60-3167	283
25-5615	459	60-358	256	60-712	273	60-3168	283
60-044	286	60-365	280	60-885	432	60-3169	257
60-127	266	60-366	280	60-886	432	60-3172	280
60-128	266	60-370	278	60-887	432	60-3173	278
60-129	266	60-371	278	60-888	432	60-3174	279
60-181	258	60-390	278	60-889	432	60-3175	265
60-182	258	60-391	279	60-890	432	60-3176	265
60-183	258	60-394	279	60-891	433	60-3177	265
60-184	258	60-395	279	60-892	433	60-3240	259
60-197	263	60-470	450	60-893	433	60-3241	259
60-198	263	60-471	450	60-894	434	60-3244	260
60-199	263	60-472	450	60-895	434	60-3245	260
60-200	260	60-473	450	60-896	434	60-3246	260
60-201	260	60-487	439	60-897	435	60-3249	273
60-202	260	60-488	439	60-898	435	60-3255	257
60-203	278	60-489	439	60-899	435	60-3257	280
60-204	278	60-516	446	60-985	436	60-3258	279
60-205	262	60-517	446	60-986	436	60-3259	279
60-206	262	60-518	447	60-987	436	60-3261	263
60-207	262	60-519	447	60-988	436	60-3262	263
60-208	261	60-520	443	60-989	436	60-3263	263
60-209	261	60-521	443	60-990	436	60-3264	283
60-210	261	60-522	443	60-991	437	60-3265	283
60-221	266	60-523	443	60-992	437	60-3266	283
60-222	266	60-524	443	60-993	437	60-3271	264
60-223	266	60-525	443	60-994	437	60-3272	264
60-245	273	60-526	446	60-995	437	60-3273	264
60-247	273	60-527	446	60-996	437	60-3277	283
60-257	273	60-528	447	60-1284	284	60-3278	282
60-270	264	60-529	447	60-1285	284	60-3279	282
60-271	264	60-530	446	60-1286	284	60-3281	282
60-280	265	60-531	446	60-1287	284	60-3282	282
60-281	265	60-532	447	60-1703	76	60-3283	282
60-282	265	60-533	447	60-1707	76	60-4001	185
60-283	264	60-534	442	60-1708	76	60-4002	185
60-284	264	60-535	442	60-1709	76	60-4003	185
60-285	264	60-536	442	60-1711	76	60-4004	185
60-290	282	60-537	442	60-1822	176	60-4081	157
60-291	282	60-538	442	60-1824	176	60-4082	157
60-292	282	60-539	442	60-1825	176	60-4083	157
60-295	273	60-540	438	60-1826	176	60-4084	157
60-296	284	60-541	438	60-1831	176	60-4085	157
60-297	284	60-542	438	60-1834	176	60-4086	157
60-298	284	60-546	439	60-1835	176	60-4087	157
60-299	284	60-547	439	60-2851	159	60-4088	157
60-300	284	60-548	439	60-2853	159	60-4091	157
60-301	284	60-608	178	60-2857	159	60-4141	168
60-302	284	60-609	178	60-2859	159	60-4142	168
60-303	284	60-611	178	60-2862	159	60-4143	168
60-316	282	60-612	178	60-2864	159	60-4145	168
60-317	282	60-613	178	60-2866	159	60-4147	168
60-318	282	60-614	178	60-2868	159	60-4148	168
60-319	282	60-615	178	60-2871	159	60-4151	168
60-320	282	60-630	440	60-2873	159	60-4152	168
60-321	282	60-631	440	60-2875	159	60-4153	168
60-322	282	60-632	440	60-2932	47	60-4581	182
60-323	282	60-633	440	60-2934	47	60-4582	182
60-324	282	60-634	440	60-2936	47	60-4583	182
60-325	282	60-635	440	60-3141	259	60-4584	182
60-326	282	60-636	441	60-3142	259	60-4588	182
60-327	282	60-637	441	60-3145	262	60-4591	182
60-336	283	60-638	441	60-3146	262	60-4593	182
60-337	283	60-639	441	60-3147	262	60-4641	183
60-338	283	60-640	441	60-3148	261	60-4642	183
60-339	283	60-641	441	60-3149	261	60-4643	183
60-340	283	60-641	458	60-3151	261	60-4644	183
60-341	283	60-673	458	60-3155	282	60-4648	183
60-342	283	60-674	458	60-3161	282	60-4651	183

60-4737	113	60-5131	170	60-5507	87	60-5927	164
60-4738	113	60-5132	170	60-5508	87	60-5928	164
60-4741	113	60-5133	170	60-5509	87	60-5932	381
60-4754	111	60-5134	170	60-5511	87	60-5933	381
60-4756	111	60-5135	170	60-5512	87	60-5934	381
60-4758	111	60-5137	170	60-5513	87	60-5943	372
60-4761	111	60-5138	170	60-5514	87	60-5944	372
60-4801	274	60-5141	170	60-5515	87	60-5945	372
60-4802	274	60-5143	170	60-5516	87	60-5946	372
60-4803	274	60-5144	170	60-5586	249	60-5951	431
60-4804	274	60-5181	186	60-5601	404	60-5952	431
60-4901	422	60-5182	186	60-5602	404	60-5953	431
60-4902	422	60-5183	186	60-5603	404	60-5954	431
60-4903	422	60-5184	186	60-5604	404	60-5955	431
60-4904	422	60-5201	179	60-5605	404	60-5956	431
60-4905	422	60-5202	179	60-5606	404	60-5957	374
60-4906	422	60-5203	179	60-5611	411	60-5958	374
60-4907	423	60-5204	179	60-5612	411	60-5959	374
60-4908	423	60-5207	179	60-5613	411	60-5974	164
60-4909	423	60-5261	81	60-5614	411	60-5975	164
60-4911	423	60-5262	81	60-5615	411	60-5976	164
60-4912	423	60-5263	81	60-5616	411	60-5995	373
60-4913	423	60-5301	179	60-5621	406	60-5996	373
60-4921	424	60-5302	179	60-5622	406	60-5997	373
60-4922	424	60-5303	179	60-5623	406	60-5998	373
60-4923	424	60-5304	179	60-5624	406	60-6115	378
60-4924	424	60-5307	179	60-5625	406	60-6116	378
60-4925	424	60-5331	175	60-5626	406	60-6117	378
60-4926	424	60-5332	175	60-5758	379	60-6118	378
60-4927	425	60-5333	175	60-5759	379	60-6119	378
60-4928	425	60-5335	175	60-5760	379	60-6121	142
60-4929	425	60-5336	175	60-5801	166	60-6122	142
60-4931	425	60-5337	175	60-5802	166	60-6123	142
60-4932	425	60-5361	81	60-5803	166	60-6124	142
60-4933	425	60-5362	81	60-5804	166	60-6125	142
60-4951	430	60-5363	81	60-5805	166	60-6126	142
60-4952	430	60-5373	185	60-5806	166	60-6127	142
60-4953	430	60-5374	287	60-5807	166	60-6128	142
60-4954	431	60-5375	287	60-5808	166	60-6129	142
60-4955	431	60-5376	287	60-5821	164	60-6381	226
60-4956	431	60-5377	287	60-5822	164	60-6382	226
60-4957	430	60-5378	286	60-5823	164	60-6401	382
60-4958	430	60-5379	286	60-5824	164	60-6402	382
60-4959	430	60-5381	286	60-5825	164	60-6403	382
60-4961	427	60-5382	286	60-5826	164	60-6405	382
60-4962	427	60-5401	85	60-5827	164	60-6406	382
60-4963	427	60-5402	85	60-5828	164	60-6411	152
60-4964	427	60-5403	85	60-5831	408	60-6412	152
60-4965	427	60-5404	85	60-5832	408	60-6413	152
60-4966	427	60-5405	85	60-5833	408	60-6414	152
60-4967	426	60-5406	85	60-5834	408	60-6415	152
60-4968	426	60-5407	85	60-5835	408	60-6416	152
60-4969	426	60-5408	85	60-5836	408	60-6417	152
60-4971	426	60-5409	85	60-5851	173	60-6431	114
60-4972	426	60-5411	85	60-5854	173	60-6432	114
60-4973	426	60-5412	85	60-5855	173	60-6434	114
60-4974	428	60-5413	85	60-5856	173	60-6435	114
60-4975	428	60-5414	85	60-5859	173	60-6436	114
60-4976	428	60-5415	85	60-5860	173	60-6501	387
60-4977	428	60-5416	85	60-5871	166	60-6502	387
60-4978	428	60-5450	180	60-5874	164	60-6503	387
60-4979	428	60-5451	180	60-5875	164	60-6504	387
60-5031	170	60-5452	180	60-5876	164	60-6511	380
60-5032	170	60-5453	180	60-5891	56	60-6512	380
60-5033	170	60-5454	180	60-5892	56	60-6513	380
60-5034	170	60-5457	180	60-5893	56	60-6514	380
60-5035	170	60-5460	180	60-5894	56	60-6543	112
60-5036	170	60-5486	249	60-5895	56	60-6544	112
60-5037	170	60-5501	87	60-5921	164	60-6545	112
60-5038	170	60-5502	87	60-5922	164	60-6571	384
60-5041	170	60-5503	87	60-5923	164	60-6572	384
60-5042	170	60-5504	87	60-5924	164	60-6573	384
60-5043	170	60-5505	87	60-5925	164	60-6574	384
60-5044	170	60-5506	87	60-5926	164	60-6575	384

# INDEX

60-6578	419	60-6860	79	60-7116	141	60-7289	162
60-6579	419	60-6861	103	60-7117	63	60-7290	162
60-6581	392	60-6862	103	60-7118	63	60-7291	162
60-6582	392	60-6865	80	60-7121	100	60-7311	147
60-6583	392	60-6866	80	60-7122	100	60-7312	147
60-6584	392	60-6867	82	60-7123	100	60-7313	147
60-6585	392	60-6868	82	60-7124	99	60-7314	147
60-6591	391	60-6869	79	60-7125	99	60-7315	147
60-6592	391	60-6870	79	60-7126	100	60-7321	51
60-6593	391	60-6871	103	60-7127	63	60-7322	51
60-6594	391	60-6872	103	60-7128	63	60-7323	51
60-6595	391	60-6875	80	60-7131	100	60-7324	51
60-6641	150	60-6876	80	60-7132	100	60-7331	51
60-6642	150	60-6877	82	60-7133	100	60-7332	51
60-6643	150	60-6878	82	60-7134	99	60-7333	51
60-6644	150	60-6879	79	60-7135	99	60-7334	51
60-6651	150	60-6880	79	60-7136	100	60-7341	102
60-6652	150	60-6971	149	60-7137	63	60-7342	102
60-6653	150	60-6972	149	60-7138	63	60-7343	102
60-6654	150	60-6973	149	60-7140	52	60-7344	102
60-6671	98	60-6974	149	60-7141	52	60-7351	102
60-6672	98	60-6975	149	60-7142	83	60-7352	102
60-6673	98	60-6976	149	60-7143	83	60-7353	102
60-6681	231	60-6977	149	60-7150	52	60-7354	102
60-6682	231	60-6980	50	60-7151	52	60-7361	239
60-6687	230	60-6991	104	60-7152	83	60-7362	239
60-6688	230	60-6992	104	60-7153	83	60-7363	239
60-6689	230	60-6993	104	60-7160	52	60-7367	238
60-6691	232	60-6994	104	60-7161	52	60-7368	238
60-6692	232	60-6996	250	60-7168	160	60-7369	238
60-6693	232	60-6997	250	60-7169	160	60-7371	394
60-6697	94	60-6998	250	60-7170	160	60-7372	394
60-6698	94	60-7001	416	60-7171	160	60-7375	395
60-6699	94	60-7002	416	60-7172	160	60-7376	395
60-6707	233	60-7003	416	60-7173	160	60-7377	395
60-6708	233	60-7004	416	60-7174	160	60-7378	395
60-6709	233	60-7011	416	60-7175	160	60-7391	237
60-6717	229	60-7012	416	60-7176	160	60-7392	237
60-6718	229	60-7013	416	60-7177	160	60-7393	237
60-6719	229	60-7014	416	60-7178	160	60-7394	237
60-6730	105	60-7021	416	60-7179	160	60-7408	74
60-6731	95	60-7022	416	60-7180	162	60-7409	74
60-6732	95	60-7023	416	60-7181	162	60-7410	74
60-6733	95	60-7024	416	60-7182	162	60-7411	74
60-6734	95	60-7046	109	60-7183	162	60-7412	74
60-6735	95	60-7047	109	60-7184	162	60-7413	74
60-6736	95	60-7048	109	60-7185	162	60-7414	74
60-6748	93	60-7056	109	60-7186	162	60-7415	74
60-6749	93	60-7057	109	60-7187	162	60-7416	74
60-6757	92	60-7058	109	60-7188	162	60-7417	74
60-6758	92	60-7059	91	60-7189	162	60-7418	74
60-6759	92	60-7060	91	60-7190	162	60-7419	74
60-6771	235	60-7066	109	60-7191	162	60-7420	74
60-6772	235	60-7067	109	60-7268	160	60-7421	74
60-6773	235	60-7068	109	60-7269	160	60-7422	74
60-6778	252	60-7069	91	60-7270	160	60-7445	74
60-6779	252	60-7070	91	60-7271	160	60-7446	74
60-6781	235	60-7076	62	60-7272	160	60-7449	74
60-6782	235	60-7077	62	60-7273	160	60-7458	73
60-6783	235	60-7086	62	60-7274	160	60-7459	73
60-6784	235	60-7087	62	60-7275	160	60-7460	73
60-6785	235	60-7096	62	60-7276	160	60-7461	73
60-6786	235	60-7097	62	60-7277	160	60-7462	73
60-6791	235	60-7101	141	60-7278	160	60-7463	73
60-6792	235	60-7102	141	60-7279	160	60-7464	73
60-6793	235	60-7103	141	60-7280	162	60-7465	73
60-6797	253	60-7104	141	60-7281	162	60-7467	61
60-6798	253	60-7105	141	60-7282	162	60-7468	61
60-6799	253	60-7106	141	60-7283	162	60-7469	61
60-6855	80	60-7111	141	60-7284	162	60-7470	61
60-6856	80	60-7112	141	60-7285	162	60-7471	61
60-6857	82	60-7113	141	60-7286	162	60-7472	61
60-6858	82	60-7114	141	60-7287	162	60-7473	61
60-6859	79	60-7115	141	60-7288	162	60-7474	61

60-7475	61	60-7775	69	60-7918	70	60-8132	375
60-7476	61	60-7776	64	60-7921	72	60-8133	375
60-7477	61	60-7777	64	60-7922	72	60-8134	375
60-7478	61	60-7778	64	60-7923	72	60-8135	375
60-7480	59	60-7780	69	60-7931	107	60-8201	133
60-7481	59	60-7781	69	60-7932	107	60-8202	133
60-7482	59	60-7782	69	60-7938	53	60-8203	133
60-7483	59	60-7783	69	60-7939	53	60-8204	133
60-7484	59	60-7784	69	60-7941	107	60-8205	133
60-7485	59	60-7785	69	60-7942	107	60-8206	133
60-7486	59	60-7800	89	60-7948	53	60-8207	133
60-7487	59	60-7801	89	60-7949	53	60-8208	133
60-7488	59	60-7802	89	60-7951	107	60-8209	133
60-7490	59	60-7803	89	60-7952	107	60-8211	133
60-7491	59	60-7804	89	60-7961	117	60-8212	133
60-7492	59	60-7805	89	60-7962	117	60-8213	133
60-7493	59	60-7806	89	60-7971	117	60-8214	133
60-7494	59	60-7807	89	60-7972	117	60-8215	133
60-7495	59	60-7808	89	60-8001	66	60-8216	133
60-7496	59	60-7810	184	60-8002	66	60-8217	133
60-7497	59	60-7811	184	60-8003	66	60-8218	133
60-7498	59	60-7812	184	60-8011	66	60-8219	133
60-7519	65	60-7813	184	60-8012	66	60-8220	123
60-7520	65	60-7815	88	60-8013	66	60-8221	123
60-7521	65	60-7816	88	60-8021	138	60-8222	123
60-7522	65	60-7817	88	60-8022	138	60-8223	123
60-7523	65	60-7818	88	60-8023	138	60-8224	123
60-7524	65	60-7819	88	60-8024	138	60-8225	123
60-7525	65	60-7820	88	60-8025	138	60-8226	123
60-7526	65	60-7821	88	60-8026	138	60-8227	123
60-7529	126	60-7822	88	60-8027	138	60-8228	123
60-7530	126	60-7823	88	60-8031	144	60-8229	123
60-7531	126	60-7840	55	60-8032	144	60-8230	123
60-7532	126	60-7841	55	60-8033	144	60-8231	123
60-7533	126	60-7842	55	60-8034	144	60-8232	123
60-7534	126	60-7843	55	60-8035	144	60-8233	123
60-7535	126	60-7844	55	60-8036	144	60-8234	123
60-7536	126	60-7850	55	60-8037	144	60-8235	123
60-7537	126	60-7851	55	60-8038	144	60-8236	123
60-7538	126	60-7852	55	60-8041	97	60-8237	123
60-7540	402	60-7853	55	60-8042	97	60-8238	123
60-7541	402	60-7854	55	60-8043	97	60-8239	123
60-7542	402	60-7860	71	60-8044	97	60-8251	129
60-7543	401	60-7861	71	60-8051	97	60-8252	129
60-7544	401	60-7862	71	60-8052	97	60-8253	129
60-7545	401	60-7863	71	60-8053	97	60-8254	129
60-7629	126	60-7870	71	60-8054	97	60-8255	129
60-7630	126	60-7871	71	60-8061	137	60-8256	129
60-7631	126	60-7872	71	60-8062	137	60-8257	129
60-7632	126	60-7873	71	60-8063	137	60-8258	129
60-7633	126	60-7875	68	60-8064	137	60-8259	129
60-7634	126	60-7876	68	60-8065	137	60-8261	129
60-7635	126	60-7877	68	60-8066	137	60-8262	129
60-7636	126	60-7878	68	60-8071	155	60-8263	129
60-7637	126	60-7881	125	60-8072	155	60-8264	129
60-7638	126	60-7882	124	60-8073	155	60-8265	129
60-7696	110	60-7883	124	60-8074	155	60-8266	129
60-7697	110	60-7884	124	60-8075	155	60-8267	129
60-7750	248	60-7885	125	60-8101	389	60-8268	129
60-7751	248	60-7886	124	60-8102	389	60-8269	129
60-7752	248	60-7887	125	60-8103	389	60-8331	121
60-7753	248	60-7901	72	60-8104	389	60-8332	121
60-7760	248	60-7902	72	60-8105	389	60-8333	121
60-7761	248	60-7903	72	60-8111	388	60-8334	121
60-7762	248	60-7905	70	60-8112	388	60-8335	121
60-7763	248	60-7906	70	60-8113	388	60-8336	121
60-7766	64	60-7907	70	60-8114	388	60-8337	121
60-7767	64	60-7908	70	60-8115	388	60-8338	121
60-7768	64	60-7911	72	60-8121	376	60-8341	121
60-7770	69	60-7912	72	60-8122	376	60-8342	121
60-7771	69	60-7913	72	60-8123	376	60-8343	121
60-7772	69	60-7915	70	60-8124	376	60-8344	121
60-7773	69	60-7916	70	60-8125	376	60-8345	121
60-7774	69	60-7917	70	60-8131	375	60-8346	121

# INDEX

60-8347	121	60-8739	119	62-744	203	62-1455R1	31
60-8348	121	62-102	225	62-816	44	62-1456R1	31
60-8501	399	62-105	48	62-817	44	62-1457R1	31
60-8502	399	62-106	48	62-818	44	62-1458R1	31
60-8503	399	62-116	48	62-819	44	62-1464R1	361
60-8504	399	62-122	225	62-820	44	62-1465R1	361
60-8505	399	62-125	48	62-826	45	62-1466R1	361
60-8510	397	62-126	48	62-827	45	62-1467R1	361
60-8511	397	62-136	48	62-828	45	62-1501	222
60-8512	397	62-185	224	62-829	45	62-1502	222
60-8513	397	62-186	224	62-830	45	62-1503	222
60-8514	397	62-245	227	62-871	192	62-1511	222
60-8520	415	62-246	227	62-872	192	62-1512	222
60-8521	415	62-247	227	62-873	192	62-1513	222
60-8530	415	62-311	212	62-874	192	62-1534	200
60-8531	415	62-312	212	62-875	192	62-1535	200
60-8540	415	62-313	212	62-876	192	62-1536	200
60-8541	415	62-314	212	62-921	189	62-1537	197
60-8550	413	62-315	212	62-922	189	62-1538	197
60-8551	413	62-316	212	62-923	189	62-1539	197
60-8560	413	62-317	212	62-924	189	62-1541	196
60-8561	413	62-318	212	62-925	189	62-1542	196
60-8570	413	62-319	212	62-926	189	62-1543	196
60-8571	413	62-524	245	62-931	194	62-1580	305
60-8601	135	62-525	245	62-932	194	62-1581	305
60-8602	135	62-526	245	62-933	194	62-1582	305
60-8603	135	62-558	241	62-934	194	62-1583	305
60-8604	135	62-559	241	62-935	194	62-1584	305
60-8605	135	62-560	241	62-936	194	62-1590	305
60-8606	135	62-568	241	62-951	46	62-1591	210
60-8607	135	62-569	241	62-952	46	62-1592	210
60-8608	135	62-570	241	62-953	46	62-1593	210
60-8609	135	62-609	243	62-954	46	62-1601	211
60-8610	135	62-631	366	62-955	46	62-1602	211
60-8611	135	62-632	366	62-992	223	62-1603	211
60-8641	131	62-633	366	62-993	223	62-1611	355
60-8642	131	62-634	366	62-994	223	62-1612	355
60-8643	131	62-635	366	62-1081	191	62-1613	355
60-8644	131	62-641	365	62-1082	191	62-1614	355
60-8645	131	62-642	365	62-1083	191	62-1615	351
60-8646	131	62-643	365	62-1101	193	62-1616	351
60-8647	131	62-644	365	62-1102	193	62-1617	351
60-8648	131	62-645	365	62-1103	193	62-1618	351
60-8649	131	62-651	362	62-1105	316	62-1619	349
60-8650	131	62-652	362	62-1106	316	62-1620	349
60-8651	131	62-653	362	62-1107	316	62-1653	353
60-8661	131	62-654	362	62-1108	316	62-1654	353
60-8662	131	62-655	362	62-1197	456	62-1655	353
60-8663	131	62-656	197	62-1198	456	62-1690	247
60-8664	131	62-658	197	62-1199	456	62-1691	247
60-8665	131	62-659	197	62-1200	456	62-1692	247
60-8666	131	62-666	196	62-1201	456	62-1693	247
60-8667	131	62-668	196	62-1202	456	62-1695	246
60-8668	131	62-669	196	62-1203	456	62-1696	246
60-8669	131	62-676	200	62-1204	456	62-1697	246
60-8670	131	62-678	200	62-1205	456	62-1698	246
60-8671	131	62-679	200	62-1206	456	62-1700	294
60-8721	119	62-686	311	62-1207	456	62-1701	294
60-8722	119	62-687	311	62-1208	456	62-1702	294
60-8723	119	62-688	311	62-1321	188	62-1703	294
60-8724	119	62-689	311	62-1322	188	62-1704	294
60-8725	119	62-700	309	62-1323	188	62-1705	294
60-8726	119	62-709	243	62-1327	190	62-1706	294
60-8727	119	62-721	203	62-1328	190	62-1707	294
60-8728	119	62-722	203	62-1329	190	62-1710	294
60-8729	119	62-723	203	62-1330	187	62-1711	294
60-8731	119	62-724	203	62-1331	187	62-1712	294
60-8732	119	62-731	203	62-1332	187	62-1713	294
60-8733	119	62-732	203	62-1425	360	62-1714	294
60-8734	119	62-733	203	62-1426	360	62-1715	294
60-8735	119	62-734	203	62-1451R1	31	62-1716	294
60-8736	119	62-741	203	62-1452R1	31	62-1717	294
60-8737	119	62-742	203	62-1453R1	31	62-1718	295
60-8738	119	62-743	203	62-1454R1	31	62-1719	295

62-1720	294	62-1874	303	62-2062	37	62-2337	221
62-1721	294	62-1875	300	62-2063	37	62-2340	221
62-1722	294	62-1876	300	62-2064	37	62-2341	221
62-1723	294	62-1877	300	62-2071	43	62-2342	221
62-1724	294	62-1878	300	62-2072	43	62-2345	221
62-1725	294	62-1879	301	62-2073	43	62-2346	221
62-1726	294	62-1880	301	62-2074	43	62-2347	221
62-1727	294	62-1881	300	62-2081	43	62-2350	215
62-1728	295	62-1885	302	62-2082	43	62-2351	215
62-1729	295	62-1886	302	62-2083	43	62-2352	215
62-1733	295	62-1890	300	62-2084	43	62-2355	215
62-1734	295	62-1891	300	62-2091	43	62-2356	215
62-1743	295	62-1900	298	62-2092	43	62-2357	215
62-1744	295	62-1901	298	62-2093	43	62-2360	215
62-1746	295	62-1902	298	62-2094	43	62-2361	215
62-1747	295	62-1903	298	62-2101	240	62-2362	215
62-1748	295	62-1904	299	62-2111	240	62-2365	217
62-1749	295	62-1905	299	62-2121	240	62-2366	217
62-1756	295	62-1906	299	62-2131	41	62-2367	217
62-1757	295	62-1907	299	62-2132	41	62-2370	217
62-1758	295	62-1910	298	62-2141	32	62-2371	217
62-1759	295	62-1911	298	62-2151	32	62-2372	217
62-1770	297	62-1912	298	62-2161	32	62-2375	217
62-1771	297	62-1913	298	62-2171	36	62-2376	217
62-1772	297	62-1914	299	62-2172	36	62-2377	217
62-1773	297	62-1915	299	62-2181	36	62-2380	205
62-1774	297	62-1916	299	62-2182	36	62-2381	205
62-1775	297	62-1917	299	62-2191	36	62-2382	205
62-1776	296	62-1920	298	62-2192	36	62-2385	205
62-1777	296	62-1921	298	62-2201	199	62-2386	205
62-1778	296	62-1922	298	62-2202	199	62-2387	205
62-1779	297	62-1923	298	62-2203	199	62-2390	205
62-1780	297	62-1924	299	62-2211	199	62-2391	205
62-1781	297	62-1925	299	62-2212	199	62-2392	205
62-1782	297	62-1926	299	62-2213	199	62-2401	19
62-1783	297	62-1927	299	62-2221	201	62-2402	19
62-1784	297	62-1942	242	62-2222	201	62-2403	19
62-1785	297	62-1943	242	62-2223	201	62-2404	19
62-1786	296	62-1944	242	62-2231	201	62-2405	19
62-1787	296	62-1971	303	62-2232	201	62-2406	19
62-1788	296	62-1972	303	62-2233	201	62-2407	19
62-1789	297	62-1975	300	62-2242	195	62-2408	19
62-1796	296	62-1976	300	62-2243	195	62-2411	17
62-1799	297	62-1977	300	62-2244	195	62-2412	17
62-1801R1	306	62-1978	300	62-2252	195	62-2413	17
62-1802R1	306	62-1979	301	62-2253	195	62-2414	17
62-1803R1	306	62-1980	301	62-2254	195	62-2415	17
62-1804R1	306	62-1981	300	62-2261	33	62-2421	29
62-1805R1	306	62-1985	302	62-2262	33	62-2422	29
62-1811R1	306	62-2001	30	62-2263	33	62-2431	29
62-1812R1	306	62-2002	30	62-2271	199	62-2432	29
62-1813R1	306	62-2003	30	62-2272	199	62-2441	27
62-1814R1	306	62-2011	30	62-2281	21	62-2442	27
62-1815R1	306	62-2012	30	62-2282	21	62-2443	27
62-1820R1	306	62-2013	30	62-2283	21	62-2444	28
62-1821R1	306	62-2021	25	62-2284	21	62-2445	28
62-1842	242	62-2022	25	62-2301	359	62-2446	28
62-1843	242	62-2023	25	62-2302	359	62-2447	28
62-1844	242	62-2024	25	62-2310	357	62-2451	35
62-1850	307	62-2025	25	62-2311	357	62-2452	35
62-1851	307	62-2031	20	62-2312	357	62-2453	35
62-1852	307	62-2032	20	62-2313	357	62-2520	209
62-1853	307	62-2033	20	62-2314	357	62-2521	209
62-1854	307	62-2034	20	62-2320	219	62-2522	209
62-1855	307	62-2035	23	62-2321	219	62-2530	209
62-1856	307	62-2036	23	62-2322	219	62-2531	209
62-1857	307	62-2037	23	62-2325	219	62-2532	209
62-1858	307	62-2041	22	62-2326	219	62-2620	207
62-1859	307	62-2042	22	62-2327	219	62-2621	207
62-1860	307	62-2051	37	62-2330	219	62-2622	207
62-1861	307	62-2052	37	62-2331	219	62-2630	207
62-1871	303	62-2053	37	62-2332	219	62-2631	207
62-1872	303	62-2054	37	62-2335	221	62-2632	207
62-1873	303	62-2061	37	62-2336	221	62-2640	207

# INDEX

62-2641	207	76-523	455	77-087	288	77-996	452
62-2642	207	76-530	455	77-088	288	86-500	454
62-2932	47	76-531	455	77-097	275	86-501	454
62-2934	47	76-600	270	77-098	275	90-1278	458
62-2936	47	76-601	272	77-099	275	90-1279	458
62-3001	42	76-602	270	77-100	275	TH200	334
62-3002	42	76-603	272	77-101	275	TH201	334
62-3011	42	76-604	270	77-102	275	TH202	334
62-3012	42	76-605	272	77-108	273	TH203	334
62-3021	42	76-606	268	77-119B	452	TH204	334
62-3022	42	76-607	268	77-120B	289	TH205	334
62-5944	369	76-608	268	77-121B	289	TH206	334
62-5945	369	76-609	268	77-125	269	TH207	334
62-5996	371	76-610	268	77-126	276	TH208	334
62-5997	371	76-611	268	77-136	451	TH209	334
62-6001	39	76-615	449	77-137	451	TH210	335
62-6002	39	76-616	448	77-138	451	TH211	335
62-6003	39	76-617	449	77-139	450	TH216	335
65-1210	308	76-618	448	77-140	450	TH217	335
65-1211	308	76-620	449	77-141	450	TH218	335
65-1212	308	76-621	449	77-152	451	TH219	335
65-1213	308	76-622	449	77-153	451	TH220	335
65-1214	308	76-623	449	77-154	451	TH221	335
65-1215	308	76-624	448	77-155	451	TH222	335
65-1220	310	76-625	448	77-156	451	TH223	335
65-1221	310	76-626	448	77-157	451	TH224	336
65-1222	310	76-627	448	77-188	285	TH225	336
65-1223	310	76-632	457	77-189	285	TH226	336
65-1224	310	76-633	457	77-190	285	TH227	336
65-1225	310	76-634	457	77-191	285	TH232	337
65-1226	310	76-635	457	77-192	285	TH233	337
65-1227	310	76-636	457	77-193	285	TH234	337
65-1228	310	76-637	457	77-194	285	TH235	337
76-091	268	76-638	458	77-195	285	TH238	337
76-092	268	76-639	458	77-323	457	TH239	337
76-093	268	76-640	458	77-324	457	TH279	336
76-124	267	76-644	458	77-487	454	TH280	336
76-125	267	76-645	456	77-488	454	TH284	336
76-126	267	76-646	456	77-494	454	TH300	335
76-127	267	76-647	456	77-495	454	TH301	335
76-128	267	76-648	456	77-530	451	TH302	336
76-129	267	76-650	459	77-531	450	TH303	334
76-130	269	76-651	459	77-532	451	TH304	334
76-131	269	76-652	459	77-533	451	TH305	334
76-132	269	76-655	456	77-693	459	TH306	335
76-133	269	76-656	456	77-700	454	TH307	334
76-191	269	76-657	456	77-701	454	TH308	334
76-192	269	76-658	456	77-702	454	TH312	337
76-193	269	76-660	281	77-703	454	TH313	337
76-243	266	76-661	281	77-823	276	TH314	337
76-244	266	76-662	281	77-824	276	TH315	337
76-245	266	76-663	281	77-835	450	TH316	337
76-251	272	76-665	458	77-852	453	TH317	337
76-253	272	76-666	458	77-853	453	TH321	337
76-257	272	76-667	458	77-857	445	TH322	337
76-268	276	76-668	458	77-858	445	TH323	337
76-269	276	76-670	271	77-859	444	TH324	336
76-270	276	76-671	271	77-861	444	TH331	336
76-273	288	76-673	271	77-863	450	TH332	336
76-276	288	76-674	271	77-879	450	TH333	336
76-277	288	76-676	271	77-891	450	TH341	334
76-283	281	76-677	271	77-896	453	TH342	334
76-284	281	76-683	455	77-897	453	TH343	334
76-412	277	76-684	455	77-898	453	TH344	334
76-416	277	76-685	455	77-899	453	TH345	334
76-418	277	76-700	452	77-932	276	TH346	335
76-422	277	76-701	452	77-947	273	TH347	335
76-500	454	76-702	452	77-969	459	TH348	335
76-501	454	76-703	452	77-987	270	TH349	336
76-502	455	76-704	452	77-989	288	TH351	337
76-503	455	76-705	452	77-990	288	TH352	337
76-520	455	77-060	270	77-991	288	TH401	322
76-521	455	77-062	270	77-992	452	TH402	322
76-522	455	77-086	288	77-995	452	TH403	322

TH404	322	TH602	323	TK319	340	TP177	344
TH405	322	TH603	323	TK320	340	TP185	342
TH407	322	TH604	323	TK321	340	TP201	343
TH411	324	TH611	323	TK322	340	TP202	343
TH412	324	TH612	323	TK323	340	TP203	343
TH413	324	TH613	323	TK340	340	TP205	343
TH414	324	TH614	323	TK341	340	TP206	343
TH415	324	TH621	323	TK342	340	TP207	343
TH417	324	TH622	323	TK343	340	TP208	343
TH421	317	TH623	323	TK345	341	TP209	343
TH422	317	TH624	323	TK346	341	TP211	343
TH423	317	TH631	327	TK347	341	TP215	344
TH424	317	TH632	327	TK348	341	TP216	344
TH425	317	TH633	327	TK349	341	TP217	344
TH427	317	TH634	327	TK352	341	TP218	343
TH431	318	TH635	322	TK353	341	TP219	343
TH432	318	TH636	322	TK354	341	TP220	343
TH433	318	TH637	319	TK355	341	TP231	344
TH434	318	TH638	319	TK361	340	TP232	344
TH435	318	TH641	327	TK362	340	TP233	344
TH437	318	TH642	327	TK403	339	TP234	343
TH441	320	TH643	327	TK404	339	TP235	343
TH442	320	TH644	327	TK407	339	TP236	343
TH443	320	TH645	322	TK413	339	TP237	343
TH444	320	TH646	322	TK414	339	TP238	343
TH445	320	TH647	319	TK417	339	TP239	343
TH447	320	TH648	319	TK423	339	TP240	344
TH451	325	TH651	328	TK424	339	TP241	344
TH452	325	TH652	328	TK427	339	TP242	344
TH453	325	TH653	328	TL100	343	TP244	344
TH454	325	TH661	328	TL101	343	TP245	344
TH455	325	TH662	328	TL102	343	TP246	344
TH457	325	TH663	328	TL103	343	TP247	344
TH461	321	TH701	330	TL104	343	TP248	344
TH462	321	TH702	330	TL105	343	TP249	344
TH463	321	TH703	330	TL106	343	TP250	344
TH464	321	TH704	330	TL110	343	TP251	344
TH465	321	TH711	330	TL111	343	TP252	344
TH467	321	TH712	330	TL112	343	TP253	344
TH471	319	TH713	330	TL113	343	TP254	344
TH472	319	TH714	330	TL114	343	TP255	344
TH473	319	TH721	330	TL115	343	TP256	344
TH474	319	TH722	330	TL116	343	TP257	344
TH475	319	TH723	330	TP142	344	TP258	344
TH477	319	TH724	330	TP143	344	TP259	344
TH480	320	TH731	332	TP144	343	TP260	344
TH481	320	TH732	332	TP145	343	TP269	343
TH482	320	TH741	332	TP146	343	TP270	343
TH483	320	TH742	332	TP147	343	TR118	342
TH484	321	TH903	314	TP148	343	TR119	342
TH485	321	TH904	314	TP149	343	TR120	342
TH486	321	TH913	314	TP150	343	TR121	342
TH487	321	TH914	314	TP151	343	TR122	342
TH488	326	TH5001	331	TP152	343	TR123	342
TH489	326	TH5002	331	TP153	343	TR124	342
TH490	326	TH5003	331	TP154	343	TR125	342
TH491	326	TH5004	331	TP155	343	TR126	342
TH492	326	TH5011	331	TP156	343	TR127	342
TH493	326	TH5012	331	TP157	343	TR128	342
TH494	329	TH5013	331	TP159	342	TR129	342
TH495	329	TH5014	331	TP160	342	TR131	342
TH496	329	TH5021	331	TP161	342	TR132	342
TH497	329	TH5022	331	TP162	342	TR133	342
TH498	329	TH5023	331	TP163	342	TR134	342
TH499	329	TH5024	331	TP164	342		
TH500	333	TH5031	332	TP165	342		
TH501	333	TH5032	332	TP166	342		
TH502	333	TH5041	332	TP167	343		
TH503	333	TH5042	332	TP168	343		
TH504	333	TK310	341	TP169	343		
TH505	333	TK315	341	TP170	343		
TH506	333	TK316	340	TP171	343		
TH507	333	TK317	340	TP172	343		
TH601	323	TK318	340	TP176	344		

To learn more about SATCO|NUVO, visit [www.satco.com](http://www.satco.com) or contact 1-800-437-2826



Like us on Facebook



Connect with us on LinkedIn



Follow us on Instagram

National Toll-Free: **1.800.437.SATCO** (1.800.437.2826)

Corporate Offices &

Distribution Center: NEW YORK 110 Heartland Blvd., Brentwood, NY 11717 | 800.437.2826 | 631.243.2022 | Fax 631.243.2027

Distribution Centers:

FLORIDA 1694 NW 215th St. Miami Gardens, FL 33056 | Tel. 305.624.2044 FAX 305.623.0286

CALIFORNIA 31288 San Benito St. Hayward, CA 94544 | Tel. 510.487.4822 FAX 510.487.8955

WASHINGTON 4710 116th St. S.W., Mukilteo, WA 98275 | Tel. 425.789.3300 FAX 425.789.3310

TEXAS 2000 Valwood Parkway, Farmers Branch, TX 75234 | Tel. 972.247.2437 FAX 972.247.5408

PUERTO RICO Campeche St. 23, Julio N. Matos Industrial Park, Carolina, PR 00984 | Tel. 787.757.3510 FAX 787.757.3540

Catalog NU4050-2 9/25

© Copyright 2025, SATCO Products, Inc

Product specifications and availability are subject to change without notice.

Please visit us online at [www.satco.com](http://www.satco.com) for our full product line and ordering details, or consult factory for additional information

