

LED ARCHITECTURAL DOWNLIGHTS

3.5" | REMOTE DRIVER



CCT Selectable Switch



ColorQuick
Selectable Color Technology

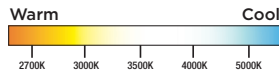

5-CCT SELECTABLE

EXCELLENT COLOR RENDERING

ROUND & SQUARE TRIMS IN WHITE, BLACK, AND BRUSHED NICKEL

DURABLE ALUMINUM TRIM AND ACRYLIC LENS

SUGGESTED APPLICATIONS

- Residential
- Multifamily
- Hospitality
- Retail

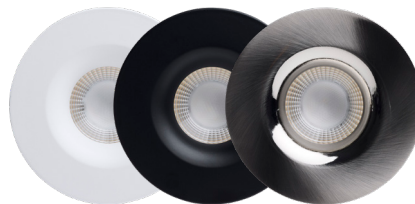

Available in White, Black, and Brushed Nickel Finish



Available in White, Black, and Brushed Nickel Finish

SATCO|NUVO's LED Architectural Downlights with Remote Driver offers an option for a small aperture aesthetic with the energy savings of LED technology. The 40° beam angle provides focused illumination while creating the ambiance of your choice with five CCT choices from warm 2700K to cool 5000K at installation. Choose from round or square trims in white, black, or brushed nickel to easily complement any décor.



GENERAL SPECIFICATIONS

Input Voltage: 120V
Frequency: 50/60Hz
Power Factor: >0.9
THD %: <30%
Dimming: Phase-Cut Dimmable Down to 10%
Efficacy: 84 LPW
CRI: 90
Location Rating: Wet









Ambient Operating Temperature:
 -20°C (-4°F) to +45°C (+113°F)
IC Rated: Yes
AT Rated: Yes
Construction: Aluminum
Lens Construction: Acrylic
Functional Life: 50,000 Hours
Warranty: 5 Years

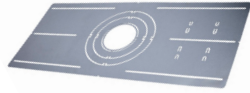

ITEM SPECIFICATIONS / ORDER INFO

Item	Shape	Finish	Beam Angle	Lumens	Wattage	Incandescent Replacement Wattage	Input Current	CCT
S11630R1	Round	White	40°	840	10W	75W	0.10A	2700K/3000K/3500K/4000K/5000K
S11631R1	Round	Black	40°	840	10W	75W	0.10A	2700K/3000K/3500K/4000K/5000K
S11632R1	Round	Brushed Nickel	40°	840	10W	75W	0.10A	2700K/3000K/3500K/4000K/5000K
S11633R1	Square	White	40°	840	10W	75W	0.10A	2700K/3000K/3500K/4000K/5000K
S11634R1	Square	Black	40°	840	10W	75W	0.10A	2700K/3000K/3500K/4000K/5000K
S11635R1	Square	Brushed Nickel	40°	840	10W	75W	0.10A	2700K/3000K/3500K/4000K/5000K

OPTIONAL ACCESSORIES (SOLD SEPARATELY)

Item	Description	
80-867	Universal New Construction Recessed Downlight Mounting Plate	
80-942	New Construction Mounting Plate with Hanger Bars	
80-949	Remote Driver Extension Cable - 6'	
80-973	Emergency Driver Enclosure	
80-987	Emergency Remote Test Switch - Single Gang Plate - White	
86-216	Remote Driver Temp Light	
S8000	5W Emergency LED Driver	
S8002	10W Emergency LED Driver	

This device complies with Part 15 of the FCC Rules. Operation is subject to the following two conditions: (1) this device may not cause harmful interference, and (2) this device must accept any interference received, including interference that may cause undesired operation.
 Fixture may not be compatible with all dimmers. See satco.com for details.
 WARNING: Some products included in this specification sheet may be subject to the warning requirements of California's Proposition 65.
 Please refer to your product packaging for more information.
 Replacement wattage shown depends on application and fixture.
 Specifications are subject to change without prior notice.

DIMENSIONS / WEIGHTS

Item	Length (A)	Width (B)	Depth (C)	Weight
S11630R1	--	4.38"	2.17"	1.01 Lbs.
S11631R1	--	4.38"	2.17"	1.01 Lbs.
S11632R1	--	4.38"	2.17"	1.01 Lbs.
S11633R1	4.38"	4.38"	2.17"	1.01 Lbs.
S11634R1	4.38"	4.38"	2.17"	1.01 Lbs.
S11635R1	4.38"	4.38"	2.17"	1.01 Lbs.

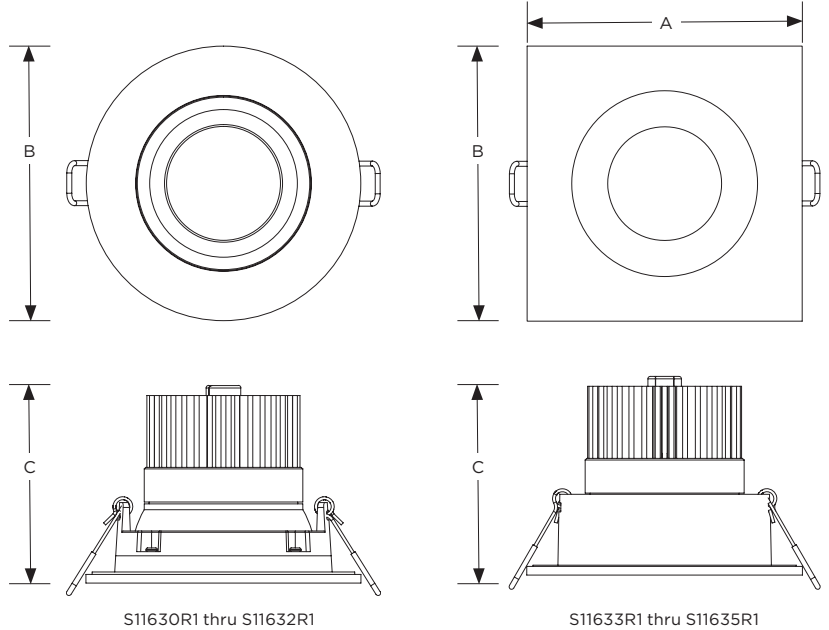

PHOTOMETRICS

SATCO Item: S11630R1 - S11635R1

Description: 10W/DW/DNL3/CCT/RND/RD/WH
 ColorQuick Setting: 2700K
 863 LM, 9.8 W, 88 LPW
 Beam Angle: 40°
 Field Angle: 95°
 Spacing Criteria (0°-180°): 0.60
 Spacing Criteria (90°-270°): 0.62

Zonal Lumens		
Zone	Lumens	%Luminaire
0-30°	514	59.6%
0-40°	671	77.8%
0-60°	833	96.6%
0-90°	862	100.0%
90-180°	0	0.0%
0-180°	862	100.0%

Lumen Multiplier				
2700K	3000K	3500K	4000K	5000K
1.00	1.08	1.16	1.19	1.13

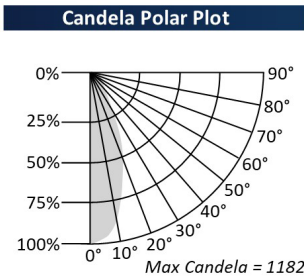

Illumination at Distance		
Distance	Center Beam	Beam Spread
4ft	74fc	2.9ft
6ft	33fc	4.3ft
8ft	19fc	5.8ft
10ft	12fc	7.2ft
12ft	8fc	8.6ft