



LED UFO HIGH BAY WITH Q-BASE

PRO series

► **DESIGN** - LED UFO HIGH BAY with Q-base PRO Series is extremely efficient with up to 170lm/W output. Die-cast aluminum housing with excellent heat dissipation along with an anti-glare PC lens provide many years of use. It can operate in temperatures ranging from -40 to 140°F. It is designed to operate on 120-277V or 277-480V circuits with a 0-10V dimmable driver. Surge protection 6kV protects the fixture from voltage spikes and current surges.

► **IP69K** - Rating provides protection against ingress of dust and high temperature, high pressure water.

► **COLOR AND POWER SELECTABLE** - You can choose either a 3,500K neutral white, 4,000K cool white or 5,000K daylight color temperature, and change the power with a simple switch.

► **INSTALLATION** - This fixture has three different mounting options: suspended, surface, and pendant. It comes with 4 ft cord. Perfect commercial or industrial solution for warehouses, supermarkets, retail stores, gyms, and many other applications.

► **ADVANTAGES** - With calculated lifespan up to 143,000 hours, these fixtures are made to last decades under normal operation! ASD provides a 5-year limited warranty along with UL and DLC Premium certifications to guarantee top quality products and safety!

Catalog number	
Notes	
Type	

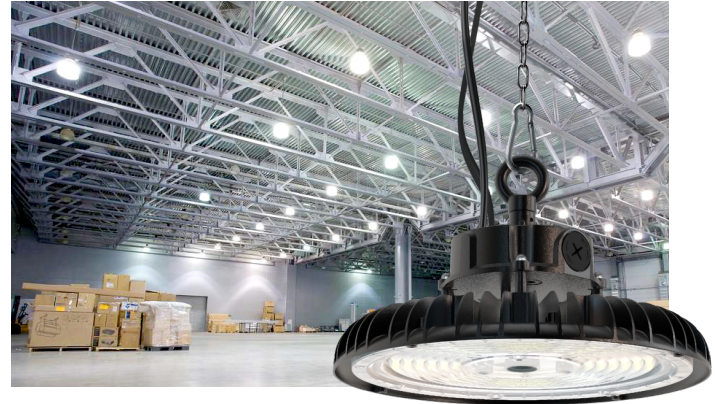

Model	Watts	Voltage	Dimmable	Lumens	CCT	Finish	Dimensions (LxWxH)	Cord	
UHB2A-PRO 170lm/W									
ASD-UHB2A-PRO-150-BK	100/120/150W	120-277 V	0-10 V	up to 24,980 lm	3CCT (3,000/4,000/5,000 K)	Black	11" x 11" x 6-3/4"	4 ft	
ASD-UHB2A-PRO-200-BK	100/150/200W	120-277 V	0-10 V	up to 33,083 lm	3CCT (3,000/4,000/5,000 K)	Black	11" x 11" x 6-3/4"	4 ft	
ASD-UHB2A-PRO-240-BK	150/200/240W	120-277 V	0-10 V	up to 40,182 lm	3CCT (3,000/4,000/5,000 K)	Black	12-5/8" x 12-5/8" x 6-3/4"	4 ft	
ASD-UHB2A-PRO-300-BK	200/240/300W	120-277 V	0-10 V	up to 49,327 lm	3CCT (3,000/4,000/5,000 K)	Black	12-5/8" x 12-5/8" x 7-15/16"	4 ft	
ASD-UHB2A-PRO-500-BK	300/400/500W	120-277 V	0-10 V	up to 82,242 lm	3CCT (3,000/4,000/5,000 K)	Black	14-9/16" x 14-9/16" x 10-1/16"	4 ft	
UHB2AHV-PRO HIGH VOLTAGE 170lm/W									
ASD-UHB2AHV-PRO-150-BK	100/120/150W	277-480 V	0-10 V	up to 24,980 lm	3CCT (3,000/4,000/5,000 K)	Black	11" x 11" x 6-7/8"	4 ft	
ASD-UHB2AHV-PRO-200-BK	100/150/200W	277-480 V	0-10 V	up to 33,083 lm	3CCT (3,000/4,000/5,000 K)	Black	11" x 11" x 6-7/8"	4 ft	
ASD-UHB2AHV-PRO-240-BK	150/200/240W	277-480 V	0-10 V	up to 40,182 lm	3CCT (3,000/4,000/5,000 K)	Black	12-5/8" x 12-5/8" x 6-7/8"	4 ft	
ASD-UHB2AHV-PRO-300-BK	200/240/300W	277-480 V	0-10 V	up to 49,327 lm	3CCT (3,000/4,000/5,000 K)	Black	12-5/8" x 12-5/8" x 7-3/8"	4 ft	
ASD-UHB2AHV-PRO-500-BK	300/400/500W	277-480 V	0-10 V	up to 82,242 lm	3CCT (3,000/4,000/5,000 K)	Black	14-9/16" x 14-9/16" x 10-1/16"	4 ft	
SENSORS AND REMOTE									
ASD-09MW-WH	Microwave motion sensor 3pin white							2-1/8" x 2-1/8" x 1-5/16"	-
ASD-09MW-BK	Microwave motion sensor 3pin black							2-1/8" x 2-1/8" x 1-5/16"	-
ASD-09IR-WH	Infrared motion sensor 3pin white							2-1/8" x 2-1/8" x 1-11/16"	-
ASD-09IR-BK	Infrared motion sensor 3pin black							2-1/8" x 2-1/8" x 1-11/16"	-
ASD-09IR50-WH	Infrared motion sensor 3pin 50ft white							2-1/8" x 2-1/8" x 1-11/16"	-
ASD-06RC	Remote control for motion sensor							5-11/16" x 1-3/4" x 13/16"	-
ASD-09MW-NLS-WH	Microwave motion sensor smart 3pin white							2-1/8" x 2-1/8" x 1-3/8"	-
ASD-09IR-NLS-WH	Infrared motion sensor smart 3pin white							2-1/8" x 2-1/8" x 1-11/16"	-
ASD-06RC-NLS	Remote control for NLS devices							5-11/16" x 1-3/4" x 13/16"	-

For detailed luminous flux information please refer to Annex 1, page 2.

For most up-to-date spec sheets please refer to asd-lighting.com



LED UFO HIGH BAY WITH Q-BASE

PRO series

PRODUCT SPECIFICATIONS:

Construction & Materials						
Housing	Aluminum					
Lens	PC					
Finish	Black					
Weight	ASD-UHB2A-PRO-150-BK	4.4 lbs (2 kg)	ASD-UHB2A-PRO-300-BK	6.8 lbs (3.1 kg)	ASD-UHB2AHV-PRO-200-BK	4.9 lbs (2.2 kg)
	ASD-UHB2A-PRO-200-BK		ASD-UHB2A-PRO-500-BK	16.8 lbs (7.6 kg)	ASD-UHB2AHV-PRO-240-BK	6 lbs (2.7 kg)
	ASD-UHB2A-PRO-240-BK	5.7 lbs (2.6 kg)	ASD-UHB2AHV-PRO-150-BK	4.4 lbs (2 kg)	ASD-UHB2AHV-PRO-300-BK	6.6 lbs (3 kg)
					ASD-UHB2AHV-PRO-500-BK	16.8 lbs (7.6 kg)
Environmental system						
Work environment	Suitable for Wet Locations, IP69K					
Operating temperature	-40°F to 140°F (-40°C to 60°C) *					
L-70 Life	ASD-UHB2A-PRO-150-BK	R > 54,000 hrs; C > 146,000 hrs	ASD-UHB2AHV-PRO-150-BK	R > 54,000 hrs; C > 146,000 hrs		
	ASD-UHB2A-PRO-200-BK		ASD-UHB2AHV-PRO-200-BK			
	ASD-UHB2A-PRO-240-BK	R > 54,000 hrs; C > 145,000 hrs	ASD-UHB2AHV-PRO-240-BK	R > 54,000 hrs; C > 145,000 hrs		
	ASD-UHB2A-PRO-300-BK	R > 54,000 hrs; C > 142,000 hrs	ASD-UHB2AHV-PRO-300-BK	R > 54,000 hrs; C > 142,000 hrs		
	ASD-UHB2A-PRO-500-BK	R > 54,000 hrs; C > 138,000 hrs	ASD-UHB2AHV-PRO-500-BK	R > 54,000 hrs; C > 146,000 hrs		
Optical system						
Color temperature	3CCT switch (3,000/4,000/5,000 K), 5,000 K by default					
CRI	> 70					
Electrical system						
Input voltage	Regular voltage: 120-277 V					
	High voltage: 277-480 V					
Max input current	ASD-UHB2A-PRO-150-BK	1.7 A	ASD-UHB2A-PRO-300-BK	2.8 A	ASD-UHB2AHV-PRO-200-BK	0.82 A
	ASD-UHB2A-PRO-200-BK	2.3 A	ASD-UHB2A-PRO-500-BK	5.6 A	ASD-UHB2AHV-PRO-240-BK	0.96 A
	ASD-UHB2A-PRO-240-BK	2.7 A	ASD-UHB2AHV-PRO-150-BK	0.6 A	ASD-UHB2AHV-PRO-300-BK	1.21 A
Inrush current (Action time)					ASD-UHB2AHV-PRO-500-BK	2.8 A
	ASD-UHB2A-PRO-150-BK	88 A (0.12 S)	ASD-UHB2A-PRO-300-BK	100 A (0.7 S)	ASD-UHB2AHV-PRO-200-BK	80 A (0.54 S)
	ASD-UHB2A-PRO-200-BK	94.5 A (0.16 S)	ASD-UHB2A-PRO-500-BK	96 A (0.47 S)	ASD-UHB2AHV-PRO-240-BK	60 A (0.65 S)
	ASD-UHB2A-PRO-240-BK	92 A (0.2 S)	ASD-UHB2AHV-PRO-150-BK	120 A (0.58 S)	ASD-UHB2AHV-PRO-300-BK	50 A (0.76 S)
					ASD-UHB2AHV-PRO-500-BK	110 A (2.4 S)
Off state power	0W					
Power consumption	ASD-UHB2A-PRO-150-BK	100/120/150W	ASD-UHB2A-PRO-300-BK	200/240/300W	ASD-UHB2AHV-PRO-200-BK	100/150/200W
	ASD-UHB2A-PRO-200-BK	100/150/200W	ASD-UHB2A-PRO-500-BK	300/400/500W	ASD-UHB2AHV-PRO-240-BK	150/200/240W
	ASD-UHB2A-PRO-240-BK	150/200/240W	ASD-UHB2AHV-PRO-150-BK	100/120/150W	ASD-UHB2AHV-PRO-300-BK	200/240/300W
				ASD-UHB2AHV-PRO-500-BK	300/400/500W	
Power factor	> 0.9					
Output voltage	252 V					
Max output current	ASD-UHB2A-PRO-150-BK	0.56 A	ASD-UHB2A-PRO-300-BK	1.13 A	ASD-UHB2AHV-PRO-200-BK	0.76 A
	ASD-UHB2A-PRO-200-BK	0.75 A	ASD-UHB2A-PRO-500-BK	1.88 A	ASD-UHB2AHV-PRO-240-BK	0.91 A
	ASD-UHB2A-PRO-240-BK	0.91 A	ASD-UHB2AHV-PRO-150-BK	0.56 A	ASD-UHB2AHV-PRO-300-BK	1.13 A
				ASD-UHB2AHV-PRO-500-BK	1.88 A	
Surge protection DM/CM	6 kV / 6 kV		for 500W models: 6 kV / 15 kV			

Dimming compatible controls				
Brand	Leviton		Lutron	
Models	ZS057-DOZ	DD710	MS-Z101	NTSTV
	DS710	IP710	DVSTV	DVTV
Regular and voluntary certifications				
5-year limited warranty				
DesignLights Consortium (DLC) listed (Classification: Premium)				
Main: Indoor luminaires; General application: High-bay;				
Primary use: High-bay luminaires for commercial and industrial buildings.				
UL certified E473804				

* Under extreme conditions fixture may enter protection mode. If ambient temperature exceeds 140°F (60°C) for an extended period, lumen output will decrease to 60% capacity. At higher sustained temperatures protection mode will terminate power to the fixture.

PACKAGE CONTENTS:

Description	Q-ty
LED UFO High Bay with Q-base	1
Safety cable (A)	1
Mounting ring (B)	1
Box	1

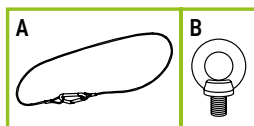

ANNEX 1

Model	Watts	3,000 K	4,000 K	5,000 K
ASD-UHB2A-PRO-150-BK ASD-UHB2AHV-PRO-150-BK	100W	15,255 lm	17,238 lm	15,636 lm
	120W	17,984 lm	20,300 lm	19,043 lm
	150W	21,714 lm	24,980 lm	22,950 lm
ASD-UHB2A-PRO-200-BK ASD-UHB2AHV-PRO-200-BK	100W	15,255 lm	17,238 lm	15,636 lm
	150W	21,714 lm	24,980 lm	22,951 lm
	200W	29,533 lm	33,083 lm	29,648 lm
ASD-UHB2A-PRO-240-BK ASD-UHB2AHV-PRO-240-BK	150W	23,397 lm	25,793 lm	24,879 lm
	200W	29,152 lm	32,876 lm	30,799 lm
	240W	35,060 lm	40,182 lm	36,861 lm
ASD-UHB2A-PRO-300-BK ASD-UHB2AHV-PRO-300-BK	200W	31,643 lm	35,103 lm	33,659 lm
	240W	36,330 lm	41,068 lm	38,847 lm
	300W	43,367 lm	49,327 lm	44,237 lm
ASD-UHB2A-PRO-500-BK ASD-UHB2AHV-PRO-500-BK	300W	46,847 lm	50,718 lm	49,330 lm
	400W	59,754 lm	66,244 lm	63,081 lm
	500W	72,554 lm	82,242 lm	76,843 lm







For most up-to-date spec sheets please refer to asd-lighting.com

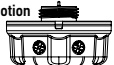
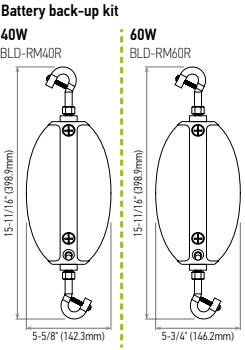
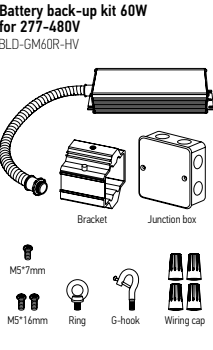
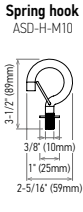
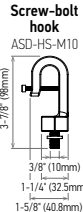
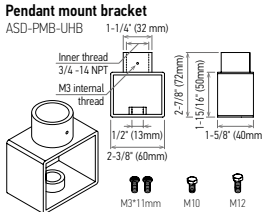
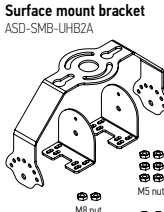
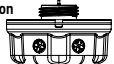
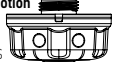
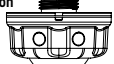

LED UFO HIGH BAY WITH Q-BASE

PRO series

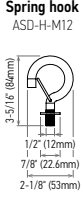
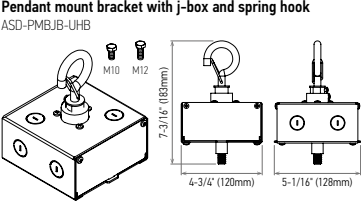
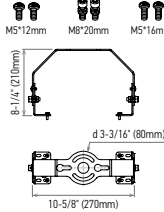
ACCESSORIES (sold separately):

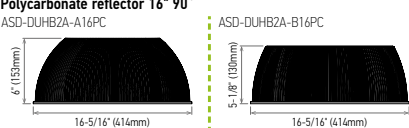
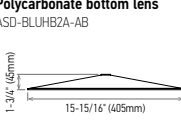
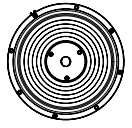
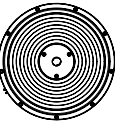
Microwave motion sensor 3pin ASD-09MW 	Battery back-up kit 40W BLD-RM40R 60W BLD-RM60R 	Battery back-up kit 60W for 277-480V BLD-GM60R-HV 	Spring hook ASD-H-M10 	Screw-bolt hook ASD-HS-M10 	Pendant mount bracket ASD-PMB-UHB 1-1/4" (32mm) 	Surface mount bracket ASD-SMB-UHB2A 
Infrared motion sensor 3pin ASD-09IR 						
Microwave motion sensor smart 3pin ASD-09MW-NLS 						
Infrared motion sensor smart 3pin ASD-09IR-NLS 						
Infrared motion sensor 3pin 50ft ASD-09IR50 	Remote test switch for battery back-up kit RN1 	Remote test switch for battery back-up kit RN1 	Spring hook ASD-H-M12 	Pendant mount bracket with j-box and spring hook ASD-PMBJB-UHB 	Surface mount bracket 	
Remote control for motion sensor ASD-06RC for NLS devices ASD-06RC-NLS 	Polycarbonate reflector 16" 90° ASD-DUHB2A-A16PC ASD-DUHB2A-B16PC 	Polycarbonate bottom lens ASD-BLUHB2A-AB 	Clear lens for 150-200W ASD-L60A-UHB2A 	Clear lens for 240-300W ASD-L60B-UHB2A 		

ACCESSORY COMPATIBILITY LIST:

Accessories	Models																	
	Microwave motion sensor 3pin ASD-09MW	Infrared motion sensor 3pin ASD-09IR ASD-09IR50	Microwave motion sensor smart 3pin ASD-09MW-NLS-WH	Infrared motion sensor smart 3pin ASD-09IR-NLS-WH	Battery back-up kit 40W BLD-RM40R	Battery back-up kit 60W BLD-RM60R	Battery back-up kit 60W for 277-480V BLD-GM60R-HV	Spring hook M10 ASD-H-M10	Spring hook M12 ASD-H-M12	Screw-bolt hook M10 ASD-HS-M10	Pendant mount bracket ASD-PMB-UHB	Pendant mount bracket with j-box and spring hook ASD-PMBJB-UHB	Surface mount bracket ASD-SMB-UHB2A	Polycarbonate bottom lens ASD-BLUHB2A-AB	Polycarbonate reflector 16" 90° ASD-DUHB2A-A16PC	Polycarbonate reflector 16" 90° ASD-DUHB2A-B16PC	Clear lens ASD-L60A-UHB2A	Clear lens ASD-L60B-UHB2A
ASD-UHB2A-PRO-150-BK	•	•	•	•	•	•	•	•	•	•	•	•	•	•	•	•	•	•
ASD-UHB2A-PRO-200-BK	•	•	•	•	•	•	•	•	•	•	•	•	•	•	•	•	•	•
ASD-UHB2A-PRO-240-BK	•	•	•	•	•	•	•	•	•	•	•	•	•	•	•	•	•	•
ASD-UHB2A-PRO-300-BK	•	•	•	•	•	•	•	•	•	•	•	•	•	•	•	•	•	•
ASD-UHB2A-PRO-500-BK	•	•	•	•	•	•	•	•	•	•	•	•	•	•	•	•	•	•
ASD-UHB2AHV-PRO-150-BK	•	•	•	•	•	•	•	•	•	•	•	•	•	•	•	•	•	•
ASD-UHB2AHV-PRO-200-BK	•	•	•	•	•	•	•	•	•	•	•	•	•	•	•	•	•	•
ASD-UHB2AHV-PRO-240-BK	•	•	•	•	•	•	•	•	•	•	•	•	•	•	•	•	•	•
ASD-UHB2AHV-PRO-300-BK	•	•	•	•	•	•	•	•	•	•	•	•	•	•	•	•	•	•
ASD-UHB2AHV-PRO-500-BK	•	•	•	•	•	•	•	•	•	•	•	•	•	•	•	•	•	•

Note: Battery back-up kit and the motion sensor cannot be installed on the same fixture.

For most up-to-date spec sheets please refer to asd-lighting.com



LED UFO HIGH BAY WITH Q-BASE

PRO series

MOTION SENSOR INFORMATION

REMOTE CONTROL **ASD-06RC** **ASD-06RC-NLS** sold separately:

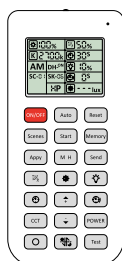

Button	Remarks	Button	Remarks	Button	Remarks
ON/OFF	ON/OFF Turn the sensor ON/OFF.	M H	Mounting height Adjust detection area/sensitivity levels according to real installation situations, higher or lower.	↑	Up The main functional buttons to adjust the factors to desired level.
Auto	Auto Enter "sensor mode" and perform previous settings.	Send	Send Memorize and send out the previous setting of individual parameters.	↓	Down Press + - button to dim light directly in non-detection mode.
Reset	Reset Enter "sensor mode" and perform the default settings.	%	Detection range Also known as "sensitivity", 100 % means the highest sensitivity and longest distance. Use this button and the + - buttons to adjust.	CCT	CCT Selectable Not applicable to this product.
Scenes	Scenes Shows current settings saved in remote.	☀	Daylight sensor The preset lux level at which motion will be detected. Use this button and the + - buttons to adjust.	POWER	Power Adjust brightness in both ON/OFF mode & sensor mode, minimum 10%, max 100%, each time this button is pressed it changes by 5%.
Start	Start Press this to begin scene setup.	⏸	Stand-by dimming After hold time, the light will dim from 100 % to optional standby dimming levels. Use this button and the + - buttons to adjust.	⏸	Reserved Button Not applicable to this product.
Memory	Memory Saves the scene settings.	⏸	Hold time The period that light will stay illuminated 100 % after no motion is detected. Use this button and the + - buttons to adjust.	☀	Daylight Harvesting Daylight harvesting function enabled or disabled.
Apply	Apply Applies current scene settings to the fixture.	⏸	Stand-by period The period after holdtime, during which the light keeps standby dimming level. Use this button and the + - buttons to adjust.	Test	Test button Press this button to test the sensor; it will temporarily change the hold time to 2s. This setting cannot be saved.

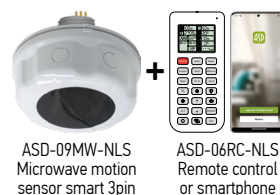
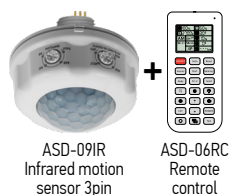
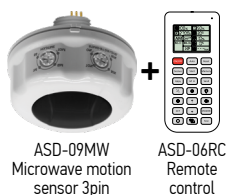

ASD-09MW, ASD-09MW-NLS:

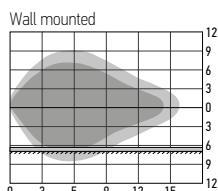
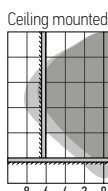

- Highest mounting height is 49.2 ft (15 m)
 - This figure indicates the maximum distance at the highest mounting height with 100 % sensitivity.
- Well detected area
 Possibly detected area

ASD-09IR, ASD-09IR50, ASD-09IR-NLS:

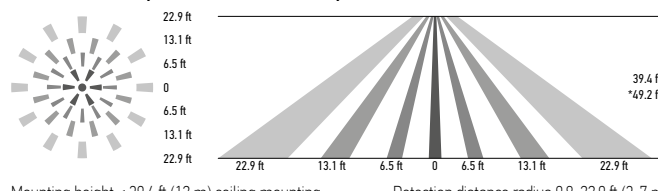

Mounting height < 39.4 ft (12 m) ceiling mounting * for ASD-09IR50 < 49.2 ft (15 m)

User notes:

1. Microwaves can penetrate walls or glass thinner than 0.8" but will be impaired if thicker than 0.8".
2. The driver voltage shall be stable and float within 10 %.
3. Detection area will be affected by speed of motion, mounting height and movement volume.
4. Conduct testing with adequate ambient lighting for best results.
5. Dimming performance differs when connected to different drivers; if the driver can't completely turn OFF, sensor can't either.
6. The first time powering ON the sensor, light will be ON 100% for about 10S then dims to standby level or OFF.

Installation precautions:

1. Designed for ceiling mount installation. If installing on a side wall, adjust the sensitivity settings accordingly, as it will become more sensitive.
2. Make sure the microwave module is completely exposed.
3. The detection surface of the sensor module should be installed facing the detection area.

Application environment:

1. Suitable for indoor application, partial/completely outdoor environment conditions might trigger the sensor.
2. Shall be mounted securely, to avoid any false triggers caused by movement of the fixture itself.
3. Keep the sensor module away from AC input and DC output to avoid high/low frequency signal interference.

User notes:

1. The driver voltage shall be stable and float within 10%.
2. Detection area options may not function as expected because they depend on the Fresnel lens, which physically determines their operation.
3. Detection distance performance works better when moving parallel to the sensor as opposed to towards it.
4. Conduct testing with adequate ambient lighting for best results.
5. Dimming performance differs when connected to different drivers; if the driver can't completely turn OFF, sensor can't either.
6. The first time powering ON the sensor, light will be ON 100% for about 45S then dims to standby level or OFF.

Installation precautions:

1. PIR sensor can't be placed inside any material, fresnel lens must be completely exposed in air.
2. Fresnel lens of the PIR sensor must be lower than the lighting fixture.
3. Designed for ceiling mount installation. If installing on a side wall, adjust the sensitivity settings accordingly, as it will become more sensitive.

Application environment:

1. Suitable for indoor application, partial/completely outdoor environment conditions might trigger the sensor.
2. The PIR sensor is not suitable for environments with sudden changes in temperature or airflow.
3. Not suitable environment if there's shelves between the sensor and target area.
4. Shall be mounted securely, to avoid any false triggers caused by movement of the fixture itself.

Specifications	Models: ASD-09MW, ASD-09MW-NLS	Models: ASD-09IR, ASD-09IR-NLS	Models: ASD-09IR50
Operating voltage	10-15 V		
Operating current	< 30 mA	< 15 mA	< 30 mA
Detection area	25 %/50 %/75 %/100 %		
Hold time	Remote control: 5 s/30 s/1 min/3 min/5 min/10 min/20 min/30 min	Built-in switch: 5 s/1 min/5 min/10 min	
Daylight threshold	2 lux (0.2 fc)/10 lux (0.9 fc)/30 lux (2.8 fc)/50 lux (4.7 fc)/80 lux (7.4 fc)/120 lux (11.2 fc)/200 lux (18.6 fc)/250 lux (23.2 fc)/300 lux (27.9 fc)/350 lux (32.5 fc)/400 lux (37.2 fc)/disable		
Standby period	0 s/10 s/30 s/1 min/5 min/10 min/30 min/60 min/+ ∞		
Standby dimming level	Remote control: 10 %/20 %/30 %/50 %	Built-in switch: 0 %/10 %/30 %/50 %	
Mounting height	max 49.2 ft (15 m)	≤ 39.4 ft (12 m)	max 49.2 ft (15 m)
Detection range	≥ 9 ft (3 m)		
Operating frequency	5.8 GHz ± 75 MHz	-	-
Transmitting power	< 0.3 mW	-	-

DEFAULT SETTING:

Specifications	
Detection area	100 %
Hold time	10 min
Daylight threshold	Disable
Stand-by period	0 s
Stand-by dimming level	10 %

For most up-to-date spec sheets please refer to asd-lighting.com



LED UFO HIGH BAY WITH Q-BASE

PRO series

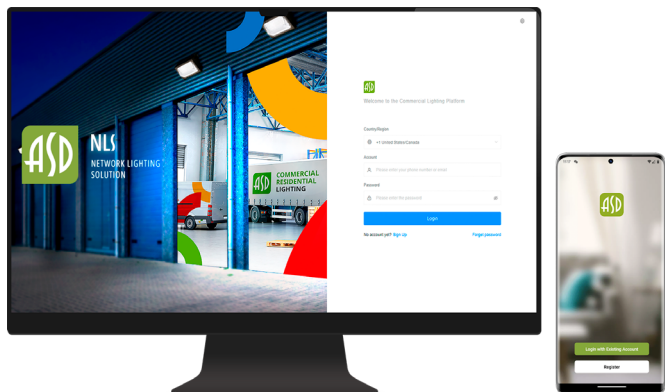

ASD NLS is a professional-grade smart control application designed to manage and control lighting fixtures in commercial properties. With ASD NLS, you can conveniently control your lights from your smartphone or PC, anytime and anywhere.

You can group fixtures by rooms, floors and objects, and create schedules based on day and time. You can also grant permanent or temporary permissions to employees and guests with different access levels. Our smart platform enables you to monitor energy usage statistics, view the status of each fixture, and much more.

► For **ASD-NLS sensors** download ASD NLS app and add the fixture to it according to the manual (download manuals and app from the links or scan the QR codes on the right).



ASD-09MW-NLS
Microwave motion sensor smart 3pin



ASD-09IR-NLS
Infrared motion sensor smart 3pin 39ft



[Desktop manual](#)



[Smartphone manual](#)



[ASD NLS app download Android](#)



[ASD NLS app download iOS](#)



FIXTURE CONTROL

Set brightness, standby time and dimming level, or apply scenes and schedules.



SCHEDULING

Set a variety of customizable start / end actions based on time of day and days of the week.



ADVANCED AREA MANAGEMENT

Create and customize projects for different types of areas, buildings, floors and zones.



CONTROL PERMISSIONS

Give your staff or installers control over the lighting.



ADVANCED ENERGY CONSUMPTION

Monitor equipment status and receive daily reports.



PROJECT OVERVIEW

Monitor device status and daily reports.

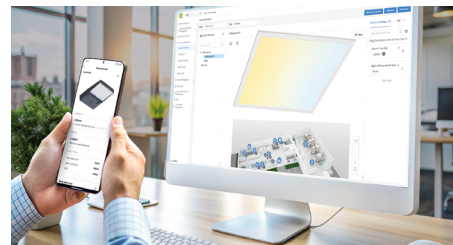

For most up-to-date spec sheets please refer to asd-lighting.com



LED UFO HIGH BAY WITH Q-BASE

PRO series

WITH DUSK/DAWN FUNCTION:

1. With insufficient ambient brightness, sensor turns on light and keeps it at standby dimming level even if there is no motion or presence.
2. When sensor detects motion or presence it will bring the light level up to 100%.
3. After motion is no longer detected, fixture remains at 100% for hold time.
4. After the preset hold time period, it will dim to the standby dimming level and maintain it indefinitely.
5. With sufficient ambient brightness, sensor will turn OFF light automatically.



WITH DAYLIGHT DISABLED:

1. Sensor turns ON light when motion is detected.
2. Light will stay on after detecting motion for the desired hold time.
3. Sensor dims light to standby dimming level after hold time if there is still no motion.
4. Sensor turns OFF light after standby period.

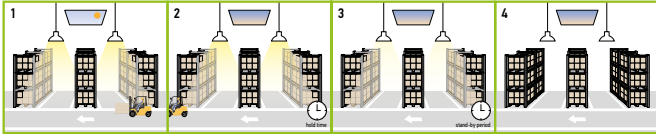

WITH DAYLIGHT THRESHOLD:

1. With sufficient daylight, the light remains OFF even after motion is detected.
2. With insufficient daylight, the sensor turns light ON when motion is detected.
3. After there's no motion detected, the sensor keeps light ON 100% for holdtime.
4. After holdtime, sensor dims light to standby dimming level for standby period. If the standby period has been set as 0s, sensor turns light OFF automatically after holdtime.
5. The sensor turns OFF light automatically after the standby period when there's no motion detected.

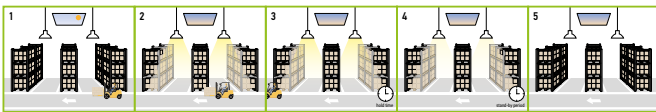

DAYLIGHT HARVESTING:

1. When the ambient brightness is lower than the preset lux level, the sensor will automatically turn on the light and adjust the dimming according to changes in ambient brightness. As it gets darker outside, the fixtures will brighten, and as it gets brighter outside, the fixtures will dim.
2. When the ambient brightness exceeds the preset lux level, the light will turn OFF.

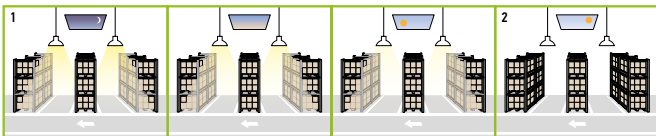

MICROWAVE MOTION SENSOR:

To avoid blocking the microwave emission, the microwave sensor can not be covered with metal materials, be sprayed with a coating of metal components, or have attached metal material or stickers etc.

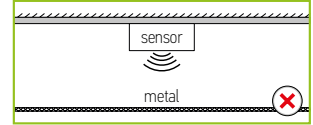

The distance between the antenna and the glass (dielectric material) should be no less than 0.4 ft when the sensor is within the glass lampshade. Otherwise, the microwave motion sensor will not penetrate the glass easily.

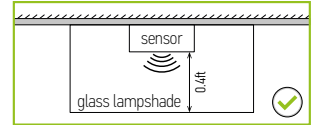

Avoid placing the sensor inside a metal chamber, this may cause a mis-trigger.

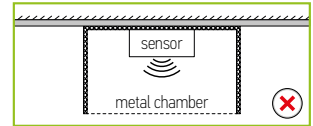

The sensor should not be placed in a small confined space. To avoid increasing the sensor detection range or abnormal operation, the sensor should be kept away from large areas of metal and glass reflectors (separation distance at least 3.3 ft). Reduce the detection area setting.

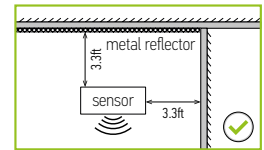

To avoid affecting the microwave signal transmission, the microwave antenna should be higher than the surrounding metal surface.

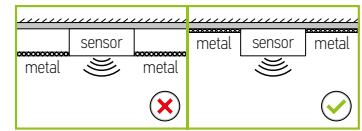

Any vibration or movement may trigger the sensor. Ensure the sensor is far from any constant movement.

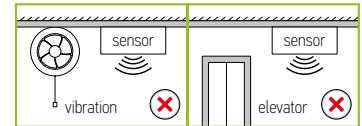

There must be at least 6.5ft between microwave sensors; There must be at least 4.9ft between the sensor and other wireless devices such as routers to avoid possible radio interference.

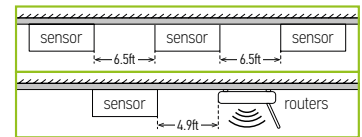

DAYLIGHT HARVESTING SETTING:

1. Adjust "daylight" value higher than 50lux.
2. Preset "standby period" 0S.
3. Press "daylight harvesting" button on remote control to activate.

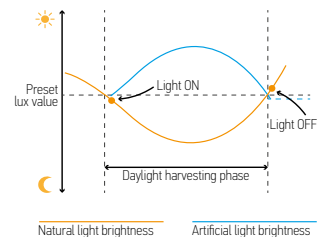

For most up-to-date spec sheets please refer to asd-lighting.com



LED UFO HIGH BAY WITH Q-BASE

PRO series

BATTERY BACK-UP KIT INFORMATION

BLD-RM40R **BLD-RM60R** sold separately:

BLD-RM40R, BLD-RM60R listed for field and factory installation, provides constant power output to the load during emergency mode operation. They maintain illumination in emergency mode for a minimum of 90 minutes. It is an ideal emergency solution for UFO LED highbay lights.

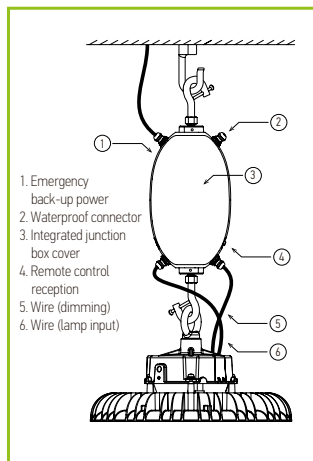

REMOTE TEST SWITCH

RN1 sold separately:

Button	Remarks
ON	Press this button to switch battery to the back-up mode. The indicator light will turn off and fixture will decrease light output.
OFF	Press this button to switch the fixture to normal operation mode.



INSTALLATION STEPS:

1. Install the G-hook to the top thread hole of the battery back-up and secure with the screw. Attach the battery back-up with G-hook to the ceiling hook.
2. Loosen the screw on the enclosed hook at the bottom of the emergency back-up, attach the ring on the fixture to the hook, and tighten screw back. Open the cover, remove the plastic covers, and install the five waterproof connectors.
3. Pull all wires through the waterproof connectors into the chamber of emergency driver. Connect wires: Brown, Blue, Green with AC input wires of the fixture. Connect dimming wires Purple and Pink with LED driver input dimming wires. Connect Black, White and Red wires of the battery back-up with AC main Power cord. Secure connection with wire nuts and close the cover of junction box.

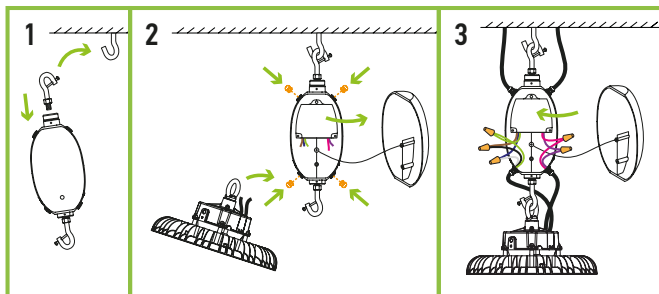

Specifications	BLD-RM40R	BLD-RM60R
Input voltage	100-347 V	
Input current	≤ 200 mA	
Input power	max 15W	
Standby input power	< 0.8W (finished charging)	
Maximum standby time between recharges	6 months	
Driver type	Constant power	
Output power (emergency mode)	40W	60W
Output voltage range	≤ 170 Vdc	
Lumens	6,000 lm	
Maximum load power	300W (when dimming to a minimum, the power needs to be less than 36W)	
Peak output power (emergency mode)	100W (lasts for 10 seconds)	
Number of output channels	1 channel	
RFI/EMI	FCC part 15 class B	
Output type	LED class 1	
Battery type	Li-ion	
Battery capacity available	2600 mAh (9% WH)	
Battery recharge time	24 hours	
Battery discharge time	90 min	
Maximum lighting fixture weight	44.1 lbs (20 kg)	
Self-diagnostic test system	<p>In the normal charging mode, the system performs a self-diagnostic test every 30 days, the system switches to emergency mode for 30S, and then automatically switches back to the normal charging mode.</p> <p>In the normal charging mode, the system switches to emergency mode every 360 days (after 11 monthly self-diagnostic test) and works until the end of discharge. Automatically switches back to normal charging mode after discharge.</p>	
Operating temperature	40°F to 122°F (5°C to 50°C)	
Service life	50,000 hours	
Input surge protection	2 kV	
Protections	Battery over discharge protection, output short circuit protection	
Approvals/class	RoHS, UL924 listed, CEC title 20 Dry/Wet Locations, IP65	

ELECTRICAL SCHEMATIC DIAGRAM:

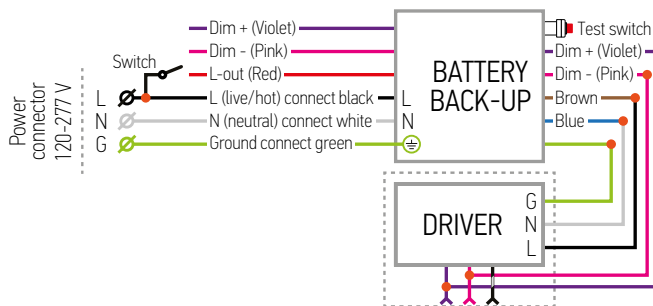

For most up-to-date spec sheets please refer to asd-lighting.com

ASD LIGHTING CORP

E-mail: orders@asd-lighting.com | Web site: www.asd-lighting.com





LED UFO HIGH BAY WITH Q-BASE

PRO series

BATTERY BACK-UP HIGH VOLTAGE KIT INFORMATION

BLD-GM60R-HV sold separately:

BLD-GM60R-HV listed for field and factory installation, provides constant power output to the load during emergency mode operation. It maintains illumination in emergency mode for a minimum of 90 minutes. It is an ideal emergency solution for UFO LED highbay lights.

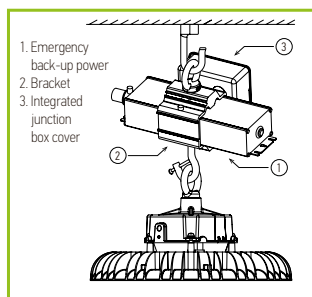
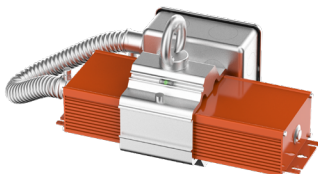

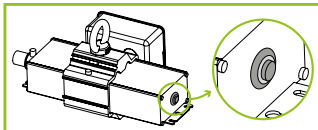

STANDARD OPERATION DISPLAY STATUS:





AC operation: AC power is present. The AC driver operates the LED load as designed. The emergency driver is charging in standby mode. The charging indicator will be lit, showing that the battery is charging.

Emergency operation: When the AC power goes out, the emergency driver detects the AC power outage and automatically switches to emergency mode. When red LED light is OFF, that means driver is discharging. When the AC power is restored, the emergency driver goes back to AC power and starts recharging.

Charging	
Emergency mode	

REMOTE TEST SWITCH

RN1 sold separately:

Button	Remarks
	ON Press this button to switch battery to the back-up mode. The indicator light will turn off and fixture will decrease light output.
	OFF Press this button to switch the fixture to normal operation mode.



ELECTRICAL SCHEMATIC DIAGRAM:

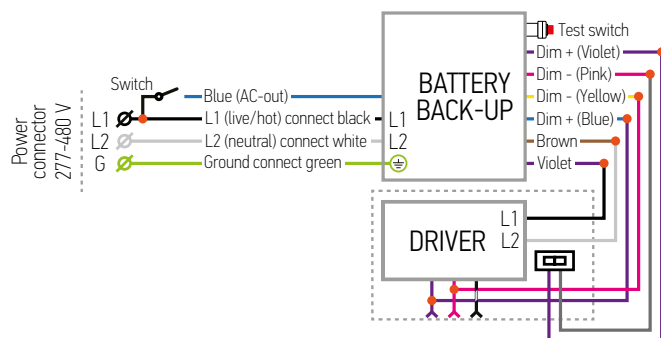

Specifications	BLD-GM60R-HV
Input voltage	277-480 V
Input current	max 100 mA
Input power	max 20W
Standby input power	< 6W (finished charging)
Maximum standby time between recharges	6 months
Driver type	Constant power
Output power (emergency mode)	60W
Output voltage range	400 Vdc
Lumens	6,000 lm
Maximum load power	300W (when dimming to a minimum, the power needs to be less than 36W)
Peak output power (emergency mode)	65W
Number of output channels	1 channel
RFI/EMI	FCC part 15 class B
Output type	LED class 1
Battery type	Li-ion
Battery capacity available	4000 mAh (115 WH)
Battery recharge time	24 hours
Battery discharge time	90 min
Maximum lighting fixture weight	44.1 lbs (20 kg)
Self-diagnostic test system	In the normal charging mode, the system performs a self-diagnostic test every 30 days, the system switches to emergency mode for 30S, and then automatically switches back to the normal charging mode. In the normal charging mode, the system switches to emergency mode every 360 days (after 11 monthly self-diagnostic test) and works until the end of discharge. Automatically switches back to normal charging mode after discharge.
Operating temperature	40°F to 122°F (5°C to 50°C)
Service life	50,000 hours
Input surge protection	2 kV
Protections	Battery over discharge protection, output short circuit protection
Approvals/class	RoHS, UL924 listed, CEC title 20 Dry/Wet Locations, IP65

INSTALLATION STEPS:

1. Insert battery back-up into the bracket and secure it with three screws. Attach junction box to the side of the bracket with two screws. Screw the mounting ring into the top and the mounting hook into the bottom of the bracket, securing them at a 45° angle.
2. Attach bracket with battery to the ceiling using mounting ring. Attach lighting fixture to the mounting hook on the bottom of the bracket and secure it with screw.
3. Plug the fixture's power cable and circuit cable into the junction box. Wire according to the wiring diagram inside the junction box. Close junction box with cover and secure it with two screws.

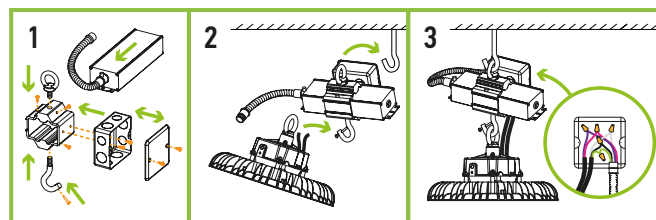

For most up-to-date spec sheets please refer to asd-lighting.com

ASD LIGHTING CORP

E-mail: orders@asd-lighting.com | Web site: www.asd-lighting.com





LED UFO HIGH BAY WITH Q-BASE

PRO series

INSTALLATION GUIDE

IMPORTANT SAFETY INFORMATION:

Please read all the instructions below before installation.

- ▶ Make sure that the supply voltage corresponds to the rated product voltage.
- ▶ The product must be installed by a qualified electrician in accordance with the National Electrical Code and corresponding local codes.
- ▶ If the product is damaged, do not use it.

⚠ WARNING

Risk of personal injury – read and follow all warnings and installation instructions. Keep or give to the owner for future reference.

Risk of cuts: Wear gloves to prevent cuts or abrasions when removing from carton, handling, installing, and maintaining this product.

Risk of electric shock: This product must be installed in accordance with the applicable installation code by a person familiar with the construction and operation of the product and the hazards involved.

Risk of Fire: Minimum 194°F supply conductors. Consult a qualified electrician to ensure correct branch circuit conductor.

ASD® assumes no responsibility for claims arising out of improper or careless installation or handling of this product.

INSTALLATION STEPS:

1. Screw on the mounting ring (included) and tighten it. For 100-300W models, unscrew the knockout on the driver box and adjust color temperature and power using the simple switch. For 500W models, open the rubber caps in the middle of the lens, remove the inner caps, and adjust color temperature and power using the simple switch.
2. Clip the fixture on the hook in the ceiling using the mounting ring. Secure the luminaire with a safety cable.
3. Connect the wires: Black to Black, White to White, Green to Green. Secure the connection with wire nuts.

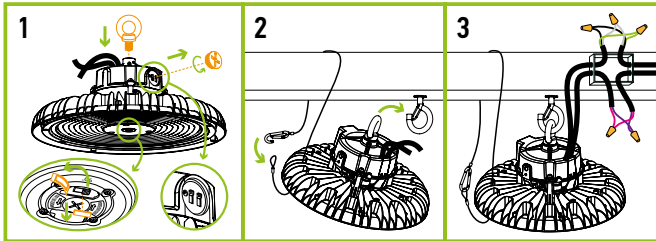

SURFACE MOUNT BRACKET INSTALLATION

ASD-SMB-UHB2A sold separately:

1. Use four M5x5/8" screws (included) to install bracket swivel on the top of the lamp body.
2. Use two M5x7/16" screws (included) to secure the bracket to the swivels.
3. Adjust the light direction and secure it using two M8x13/16" screws (included).

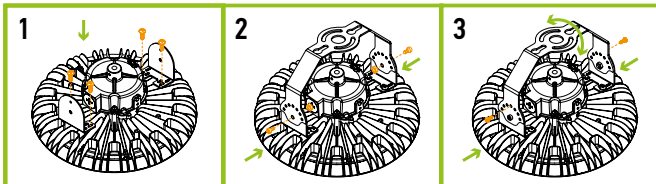

ELECTRICAL SCHEMATIC DIAGRAM:

UHB2A-PRO

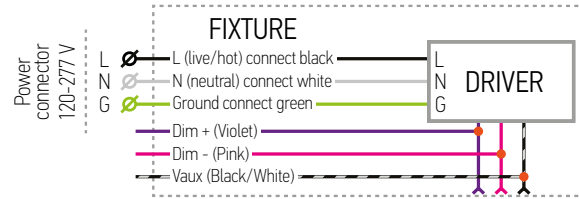

UHB2AHV-PRO

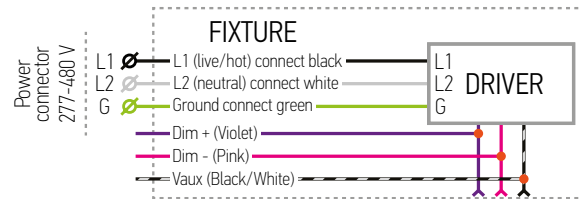

PENDANT MOUNT BRACKET INSTALLATION

ASD-PMB-UHB sold separately:

1. Remove the original ring from the driver.
2. Install the bracket and secure it to the driver using an M10 or M12 screw (included with the bracket).
3. Screw the bracket with the fixture onto a pole and secure it with an M3 screw (included with the bracket).

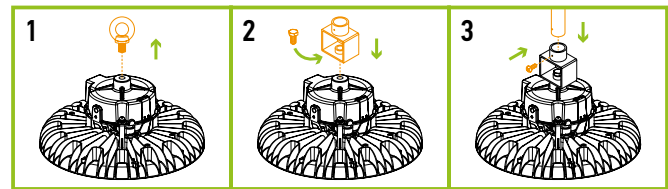

PENDANT MOUNT BRACKET WITH J-BOX AND SPRING HOOK INSTALLATION

ASD-PMBJB-UHB sold separately:

1. Uninstall the mounting ring from the fixture. Unscrew the two screws and open the side plate on the Pendant Junction box. Install M10 or M12 Mounting screw depending on the fixture's thread size.
2. **Mounting hook installation:** Loosen security screw and install the spring hook into the upper installation hole of the Pendant J-Box, then secure it with screw. Secure Pendant J-box to the fixture, and then to the ceiling. Close and secure side plate back into place.
3. **Pendant installation:** Uninstall adapter from pole mounting hole. Secure the Pendant J-box and fixture to the pole. Secure fixture to the Pendant J-box. Close and secure side plate back into place.

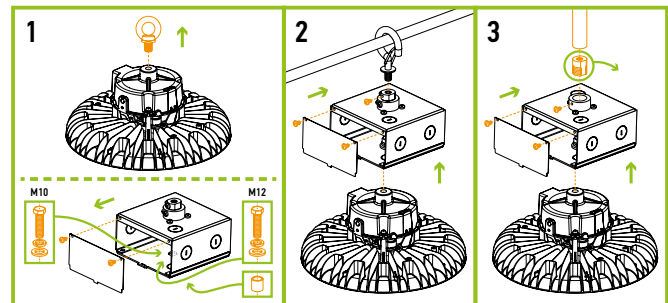

For most up-to-date spec sheets please refer to asd-lighting.com



LED UFO HIGH BAY WITH Q-BASE

PRO series

DIFFUSER AND LENS INSTALLATION

ASD-DUHB2A-A16PC ASD-DUHB2A-B16PC

ASD-BLUHB2A-AB sold separately:

1. Install the diffuser, tighten the screws.
2. Attach the conical lens to the included clamp.

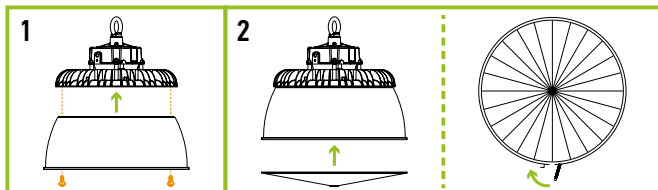

MOTION SENSOR INSTALLATION

ASD-09MW ASD-09MW-NLS

ASD-09IR ASD-09IR-NLS

ASD-09IR50 sold separately:

1. Unscrew the microwave sensor base cap.
2. Insert and twist the sensor until it is tight on the base surface.

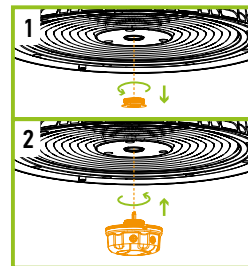

ORDERING INFORMATION

Model	UPC	Pcs. per carton	Carton size	Carton weight
UHB2A-PRO 170lm/W				
ASD-UHB2A-PRO-150-BK	810128116916	1	11.6" x 11.6" x 6.3"	5.7 lbs
ASD-UHB2A-PRO-200-BK	810128116923	1	11.6" x 11.6" x 6.3"	5.7 lbs
ASD-UHB2A-PRO-240-BK	810128116930	1	13.2" x 13.2" x 6.3"	7.1 lbs
ASD-UHB2A-PRO-300-BK	810128116947	1	13.2" x 13.2" x 6.9"	8.2 lbs
ASD-UHB2A-PRO-500-BK	810128116954	1	17.3" x 16.9" x 10.2"	18.3 lbs
UHB2AHV-PRO HIGH VOLTAGE 170lm/W				
ASD-UHB2AHV-PRO-150-BK	810128116961	1	11.6" x 11.6" x 6.3"	5.7 lbs
ASD-UHB2AHV-PRO-200-BK	810128115629	1	11.6" x 11.6" x 6.3"	6.2 lbs
ASD-UHB2AHV-PRO-240-BK	810128115636	1	13.2" x 13.2" x 6.3"	7.3 lbs
ASD-UHB2AHV-PRO-300-BK	810128115643	1	13.2" x 13.2" x 6.9"	7.9 lbs
ASD-UHB2AHV-PRO-500-BK	810128116978	1	17.3" x 16.9" x 10.2"	18.3 lbs

ACCESSORIES:

Model	Description	UPC	Pcs. in middle box	Middle box size	Middle box weight	GTIN 14 in middle box	Pcs. per carton	Carton size	Carton weight	GTIN 14
ASD-09MW-WH	Microwave motion sensor 3pin white	810128113700	10	5.5" x 2.6" x 11.4"	1.2 lbs	20810128113704	120	17.3" x 11.8" x 11"	12.1 lbs	30810128113701
ASD-09MW-BK	Microwave motion sensor 3pin black	810128113717	10	5.5" x 2.6" x 11.4"	1.2 lbs	20810128113711	120	17.3" x 11.8" x 11"	12.1 lbs	30810128113718
ASD-09IR-WH	Infrared motion sensor 3pin white	810128113694	10	5.5" x 2.6" x 11.4"	1.2 lbs	20810128113698	120	17.3" x 11.8" x 11"	12.1 lbs	30810128113695
ASD-09IR-BK	Infrared motion sensor 3pin black	810128114349	10	5.5" x 2.6" x 11.4"	1.2 lbs	20810128114343	120	17.3" x 11.8" x 11"	12.1 lbs	30810128114340
ASD-09IR50-WH	Infrared motion sensor 3pin 50ft white	810128116794	10	5.5" x 2.6" x 11.4"	0.9 lbs	10810128116791	120	17.3" x 11.8" x 11"	10.7 lbs	20810128116798
ASD-06RC	Remote control for motion sensor	810128114370	10	6.3" x 2.9" x 11.4"	0.5 lbs	30810128114371	60	15.8" x 11.8" x 9.3"	24.7 lbs	40810128114378
ASD-09MW-NLS-WH	Microwave motion sensor smart 3pin white	810128113762	10	5.5" x 2.6" x 11.4"	1.2 lbs	20810128113766	120	17.3" x 11.8" x 11"	12.1 lbs	30810128113763
ASD-09IR-NLS-WH	Infrared motion sensor smart 3pin white	810128113755	10	5.5" x 2.6" x 11.4"	1.2 lbs	20810128113759	120	17.3" x 11.8" x 11"	12.1 lbs	30810128113756
ASD-06RC-NLS	Remote control for NLS devices	810128114387	10	6.3" x 2.9" x 11.4"	0.5 lbs	20810128114381	60	15.8" x 11.8" x 9.3"	24.7 lbs	30810128114388
BLD-RM40R	Battery back-up kit 40W	810050738507	-	-	-	-	4	23.6" x 13.8" x 7.9"	32.5 lbs	20810050738501
BLD-RM60R	Battery back-up kit 60W	810128112154	-	-	-	-	4	23.6" x 13.8" x 7.9"	37.7 lbs	20810128112158
BLD-GM60R-HV	Battery back-up kit 60W for 277-480V	810128112147	-	-	-	-	5	20.5" x 10.8" x 16.7"	41.9 lbs	10810128112144
RN1	Remote test switch for battery back-up kit	810050735223	-	-	-	-	50	13" x 9.8" x 6.5"	8.3 lbs	20810050735227
ASD-H-M10	Spring hook M10	819201025312	-	-	-	-	50	12.6" x 7.7" x 6.9"	12.1 lbs	20819201025316
ASD-H-M12	Spring hook M12	810050730556	-	-	-	-	50	12.6" x 7.7" x 6.9"	17.6 lbs	10810050730553
ASD-HS-M10	Screw-bolt hook M10	810050731164	-	-	-	-	50	11.4" x 11.4" x 8.3"	12.6 lbs	10810050731161
ASD-PMB-UHB	Pendant mount bracket	810050731522	-	-	-	-	50	13.9" x 9.7" x 7.1"	33.7 lbs	10810050731529
ASD-PMBJB-UHB	Pendant mount bracket with J-box and spring hook	810050736992	-	-	-	-	40	17.7" x 11.4" x 21.3"	34.4 lbs	20810050736996
ASD-SMB-UHB2A-WH	Surface mount bracket white for 150-300W	810128115698	-	-	-	-	20	20.3" x 17.1" x 15.8"	41.5 lbs	10810128115695
ASD-SMB-UHB2A-BK	Surface mount bracket black for 150-300W	810128115681	-	-	-	-	20	20.3" x 17.1" x 15.8"	41.5 lbs	10810128115688
ASD-BLUHB2A-AB	Polycarbonate bottom lens	810128115674	-	-	-	-	20	17.3" x 17.3" x 9.8"	18.5 lbs	10810128115671
ASD-DUHB2A-A16PC	Polycarbonate reflector 16" 90° for 150-200W	810128115650	-	-	-	-	10	16.9" x 16.9" x 19.7"	12.1 lbs	10810128115657
ASD-DUHB2A-B16PC	Polycarbonate reflector 16" 90° for 240-300W	810128115667	-	-	-	-	10	16.9" x 16.9" x 19.7"	11 lbs	10810128115664
ASD-L60A-UHB2A	Clear lens for 150-200W	810128115889	-	-	-	-	20	12.3" x 11.7" x 8.7"	9.3 lbs	10810128115886
ASD-L60B-UHB2A	Clear lens for 240-300W	810128115896	-	-	-	-	20	12.2" x 12.2" x 9.5"	11.9 lbs	10810128115893

For most up-to-date spec sheets please refer to asd-lighting.com

ASD LIGHTING CORP

E-mail: orders@asd-lighting.com | Web site: www.asd-lighting.com

