

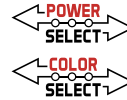

SENTINEL  
WALL MOUNT CYLINDER

FormFIT  
optic swap



# KT-CYLEDXXPS-XA-WDI-OSG-8CSB-VDIM-X

## DIRECT/INDIRECT WALL MOUNT CYLINDER

**DESCRIPTION**

Wall Mount Cylinder | Power Select | Color Select | Direct and/or Indirect Lighting | Interchangeable Optics | 120-277V Input | Multiple Finish Options

**APPLICATION**

Functional and decorative up direct/indirect outdoor wall cylinder for entryway, façade, awning, and wall washer applications



RoHS Compliant

10 YEAR LIMITED WARRANTY

**PRODUCT FEATURES**

- Keystone Power Select technology (see *PRODUCT SPECIFICATIONS for details*)
- Keystone Color Select technology (3000/4000/5000K)
- Screw-on cap and three sets of reflectors for easy optic swap (40° installed, 25° and 60° included)
- Easy-to-access dip switch for direct, indirect, or full illumination
- Compatible with slip-on shells in various finishes
- Built-in dusk-to-dawn photocell
- Die-cast aluminum housing in a modern aesthetic
- UL Certified, IP65 rated
- Ambient operating temperature: -40°C/-40°F - 45°C/113°F
- LED chip lifetime: L70 > 100,000 hrs @ 25°C/77°F ambient
- Rated life: 50,000 hours
- Meets FCC Part 15, Part B, Class A standards for conducted and radiated emissions



3" Cylinder Fixture  
Bronze



3" Cylinder Fixture  
White



3" Cylinder Fixture  
Black



4" Cylinder Fixture  
Bronze



4" Cylinder Fixture  
White



4" Cylinder Fixture  
Black



6" Cylinder Fixture  
Bronze



6" Cylinder Fixture  
White



6" Cylinder Fixture  
Black

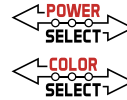

# KT-CYLEDXXPS-XA-WDI-OSG-8CSB-VDIM-X

## DIRECT/INDIRECT WALL MOUNT CYLINDER

**PRODUCT SPECIFICATIONS (SETTING: FULL)**

Catalog Number	Selectable Wattage	Selectable CCT	Lumens	Efficacy	Input Voltage	Dimming	CRI	Optics	Light Direction Control
KT-CYLED36PS-6A-WDI-OSG-8CSB-VDIM KT-CYLED36PS-6A-WDI-OSG-8CSB-VDIM-W KT-CYLED36PS-6A-WDI-OSG-8CSB-VDIM-B	36W	3000K	3,050	85 lm/W	120-277V	0-10V	> 80	40° lens installed 25° and 60° included	
		4000K	3,100	86 lm/W					
		5000K	3,200	89 lm/W					
	28W	3000K	2,500	89 lm/W					
		4000K	2,700	96 lm/W					
		5000K	2,750	98 lm/W					
	21W	3000K	2,010	96 lm/W					
		4000K	2,150	102 lm/W					
		5000K	2,210	105 lm/W					
KT-CYLED20PS-4A-WDI-OSG-8CSB-VDIM KT-CYLED20PS-4A-WDI-OSG-8CSB-VDIM-W KT-CYLED20PS-4A-WDI-OSG-8CSB-VDIM-B	20W	3000K	1,840	92 lm/W	120-277V	0-10V	> 80	40° lens installed 25° and 60° included	
		4000K	1,950	98 lm/W					
		5000K	2,050	103 lm/W					
	16W	3000K	1,500	94 lm/W					
		4000K	1,570	98 lm/W					
		5000K	1,650	103 lm/W					
	12W	3000K	1,160	97 lm/W					
		4000K	1,220	102 lm/W					
		5000K	1,290	108 lm/W					
KT-CYLED10PS-3A-WDI-OSG-8CSB-VDIM KT-CYLED10PS-3A-WDI-OSG-8CSB-VDIM-W KT-CYLED10PS-3A-WDI-OSG-8CSB-VDIM-B	10W	3000K	965	97 lm/W	120-277V	0-10V	> 80	40° lens installed 25° and 60° included	
		4000K	1,000	100 lm/W					
		5000K	1,050	105 lm/W					
	8W	3000K	785	98 lm/W					
		4000K	810	101 lm/W					
		5000K	840	105 lm/W					
	6W	3000K	605	101 lm/W					
		4000K	620	103 lm/W					
		5000K	600	100 lm/W					

(Product Specifications continued on next page)

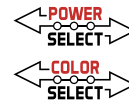

# KT-CYLEDXXPS-XA-WDI-OSG-8CSB-VDIM-X

## DIRECT/INDIRECT WALL MOUNT CYLINDER

**PRODUCT SPECIFICATIONS** (SETTING: *DIRECT OR INDIRECT*)

Catalog Number	Selectable Wattage	Selectable CCT	Lumens	Efficacy	Input Voltage	Dimming	CRI	Optics	Light Direction Control
KT-CYLED36PS-6A-WDI-OSG-8CSB-VDIM KT-CYLED36PS-6A-WDI-OSG-8CSB-VDIM-W KT-CYLED36PS-6A-WDI-OSG-8CSB-VDIM-B	18W	3000K	1,525	85 lm/W	120-277V	0-10V	> 80	40° lens installed 25° and 60° included	
		4000K	1,550	86 lm/W					
		5000K	1,600	89 lm/W					
	14W	3000K	1,250	89 lm/W					
		4000K	1,350	96 lm/W					
		5000K	1,375	98 lm/W					
	10.5W	3000K	1,005	96 lm/W					
		4000K	1,075	102 lm/W					
		5000K	1,105	105 lm/W					
KT-CYLED20PS-4A-WDI-OSG-8CSB-VDIM KT-CYLED20PS-4A-WDI-OSG-8CSB-VDIM-W KT-CYLED20PS-4A-WDI-OSG-8CSB-VDIM-B	10W	3000K	920	92 lm/W	120-277V	0-10V	> 80	40° lens installed 25° and 60° included	
		4000K	975	98 lm/W					
		5000K	1,025	103 lm/W					
	8W	3000K	750	94 lm/W					
		4000K	785	98 lm/W					
		5000K	825	103 lm/W					
	6W	3000K	580	97 lm/W					
		4000K	610	102 lm/W					
		5000K	645	108 lm/W					
KT-CYLED10PS-3A-WDI-OSG-8CSB-VDIM KT-CYLED10PS-3A-WDI-OSG-8CSB-VDIM-W KT-CYLED10PS-3A-WDI-OSG-8CSB-VDIM-B	5W	3000K	483	97 lm/W	120-277V	0-10V	> 80	40° lens installed 25° and 60° included	
		4000K	500	100 lm/W					
		5000K	525	105 lm/W					
	4W	3000K	393	98 lm/W					
		4000K	405	101 lm/W					
		5000K	420	105 lm/W					
	3W	3000K	303	101 lm/W					
		4000K	310	103 lm/W					
		5000K	300	100 lm/W					

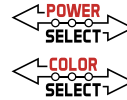

# KT-CYLEDXXPS-XA-WDI-OSG-8CSB-VDIM-X

## DIRECT/INDIRECT WALL MOUNT CYLINDER

### PHOTOMETRIC SPECIFICATIONS KT-CYLED10PS-3A-WDI-OSG-8CSB-VDIM (25° REFLECTOR WITH FULL ILLUMINATION)

**ISOCANDELA PLOT**

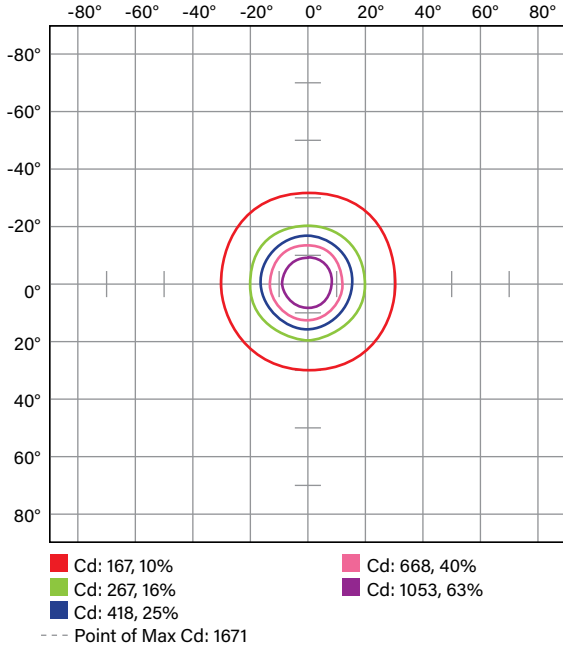

**LUMINOUS INTENSITY DISTRIBUTION**

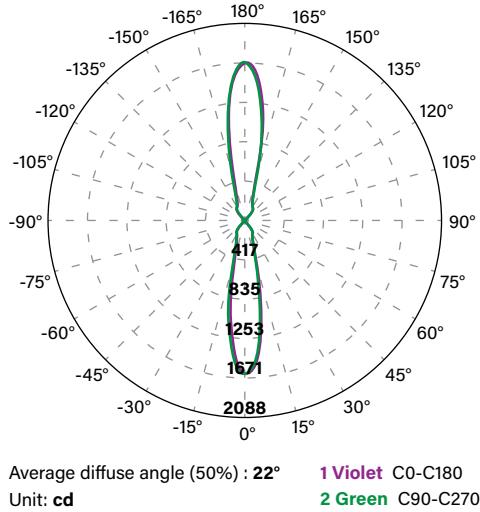

**FLUX DISTRIBUTION**

Zone	Lumens	% Luminaire
<b>Forward Light</b>	229 lm	24.5%
0°-30°	174 lm	18.6%
30°-60°	52 lm	5.6%
60°-80°	2 lm	0.2%
80°-90°	1 lm	0.1%
<b>Back Light</b>	230 lm	24.6%
0°-30°	174 lm	18.6%
30°-60°	52 lm	5.6%
60°-80°	2 lm	0.2%
80°-90°	1 lm	0.1%
<b>Up Light</b>	477 lm	50.9%
90°-100°	2 lm	0.2%
100°-180°	475 lm	50.8%

BUG* Rating	
<b>Asymmetrical Luminaire Types</b>	
Type I, II, III, IV	B1 U3 G0
<b>Quadrilateral Symmetrical Luminaire Types</b>	
Type V, Area Light	B1 U3 G0

\* Backlight, Uplight, Glare

### PHOTOMETRIC SPECIFICATIONS KT-CYLED10PS-3A-WDI-OSG-8CSB-VDIM (40° REFLECTOR WITH FULL ILLUMINATION)

**ISOCANDELA PLOT**

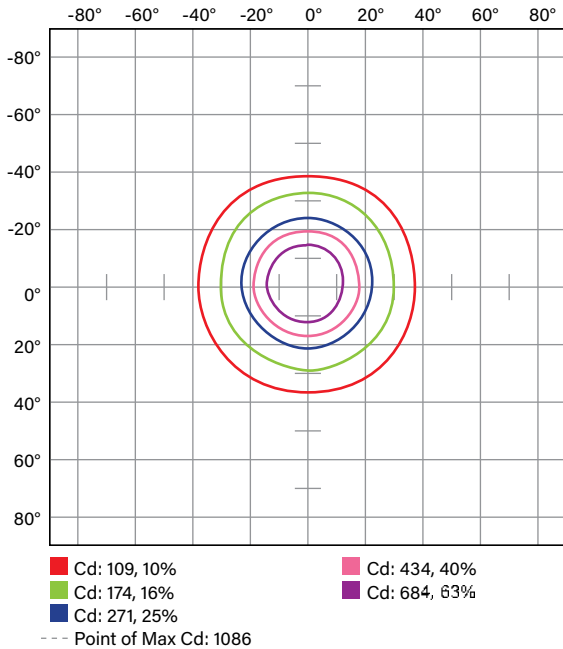

**LUMINOUS INTENSITY DISTRIBUTION**

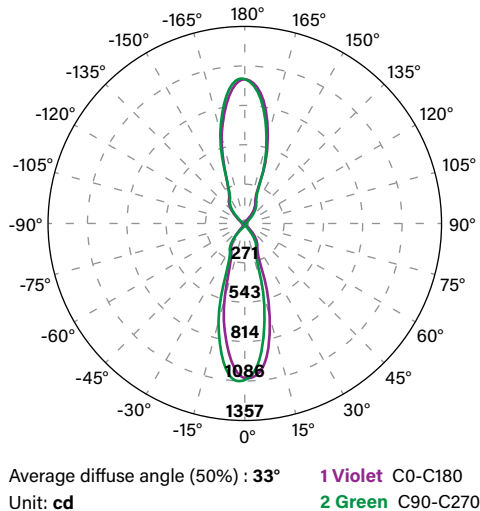

**FLUX DISTRIBUTION**

Zone	Lumens	% Luminaire
<b>Forward Light</b>	215 lm	22.8%
0°-30°	166 lm	17.6%
30°-60°	46 lm	4.9%
60°-80°	2 lm	0.2%
80°-90°	1 lm	0.1%
<b>Back Light</b>	257 lm	27.1%
0°-30°	195 lm	20.6%
30°-60°	59 lm	6.2%
60°-80°	2 lm	0.2%
80°-90°	1 lm	0.1%
<b>Up Light</b>	474 lm	50.1%
90°-100°	2 lm	0.2%
100°-180°	472 lm	49.9%

BUG* Rating	
<b>Asymmetrical Luminaire Types</b>	
Type I, II, III, IV	B1 U3 G0
<b>Quadrilateral Symmetrical Luminaire Types</b>	
Type V, Area Light	B1 U3 G0

\* Backlight, Uplight, Glare

(Photometric Specifications continued on next page)

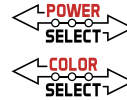

# KT-CYLEDXXPS-XA-WDI-OSG-8CSB-VDIM-X

## DIRECT/INDIRECT WALL MOUNT CYLINDER

### PHOTOMETRIC SPECIFICATIONS KT-CYLED10PS-3A-WDI-OSG-8CSB-VDIM (60° REFLECTOR WITH FULL ILLUMINATION)

#### ISOCANDELA PLOT

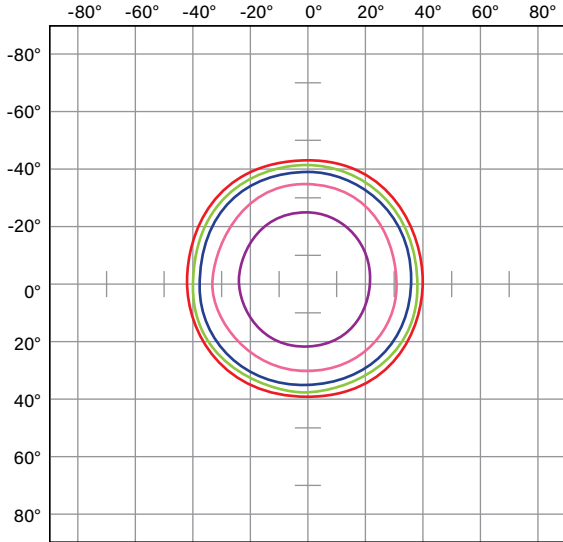

- Cd: 56, 10%
- Cd: 89, 16%
- Cd: 139, 25%
- Point of Max Cd: 558
- Cd: 223, 40%
- Cd: 352, 63%

#### LUMINOUS INTENSITY DISTRIBUTION

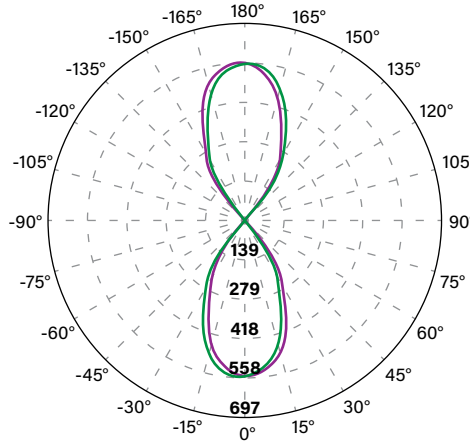

Average diffuse angle (50%) : 56°  
Unit: cd

- 1 Violet C0-C180
- 2 Green C90-C270

#### FLUX DISTRIBUTION

Zone	Lumens	% Luminaire
<b>Forward Light</b>	213 lm	23.1%
0°-30°	159 lm	17.2%
30°-60°	54 lm	5.9%
60°-80°	1 lm	0.1%
80°-90°	0 lm	0.0%
<b>Back Light</b>	243 lm	26.3%
0°-30°	169 lm	18.4%
30°-60°	72 lm	7.8%
60°-80°	1 lm	0.1%
80°-90°	0 lm	0.0%
<b>Up Light</b>	466 lm	50.6%
90°-100°	0 lm	0.2%
100°-180°	466 lm	50.6%

BUG* Rating	
<b>Asymmetrical Luminaire Types</b>	
Type I, II, III, IV	B1 U3 G0
<b>Quadrilateral Symmetrical Luminaire Types</b>	
Type V, Area Light	B1 U3 G0

\* Backlight, Uplight, Glare

### LIGHT DISTRIBUTION PATTERN

Photometric layouts for general reference only. Squares are 10ft x 10ft.

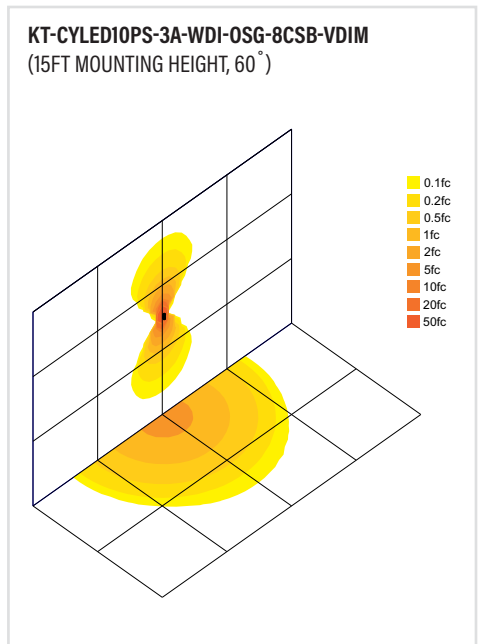
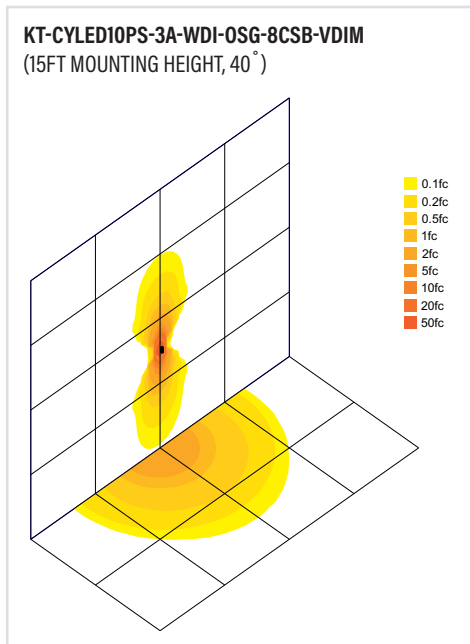
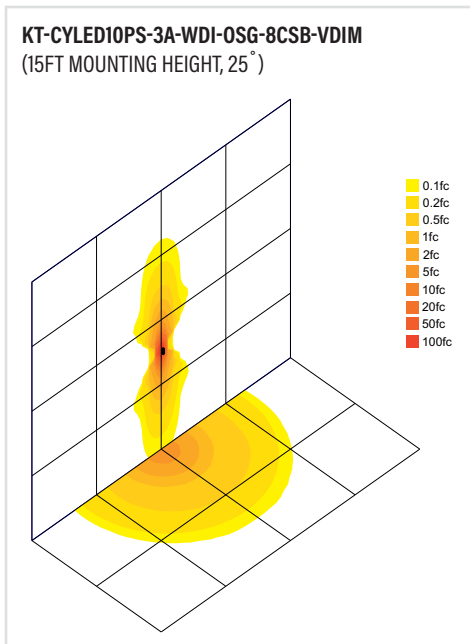



# KT-CYLEDXXPS-XA-WDI-OSG-8CSB-VDIM-X

## DIRECT/INDIRECT WALL MOUNT CYLINDER

### PHOTOMETRIC SPECIFICATIONS KT-CYLED20PS-4A-WDI-OSG-8CSB-VDIM (25° REFLECTOR WITH FULL ILLUMINATION)

ISOCANDELA PLOT

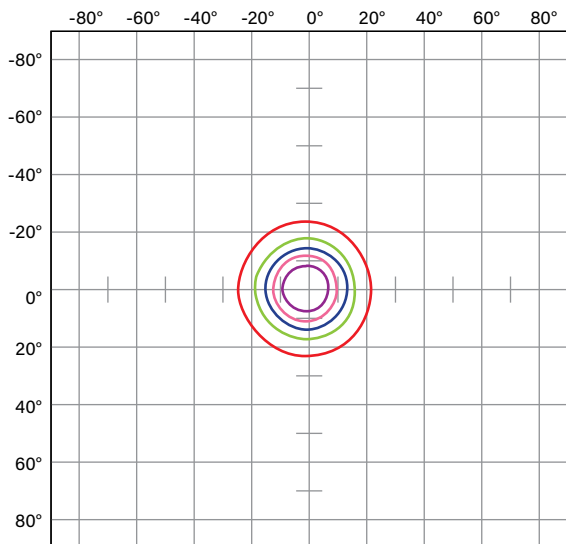

- Cd: 382, 10%
  - Cd: 612, 16%
  - Cd: 956, 25%
  - Cd: 1530, 40%
  - Cd: 2410, 63%
- Point of Max Cd: 3825

LUMINOUS INTENSITY DISTRIBUTION

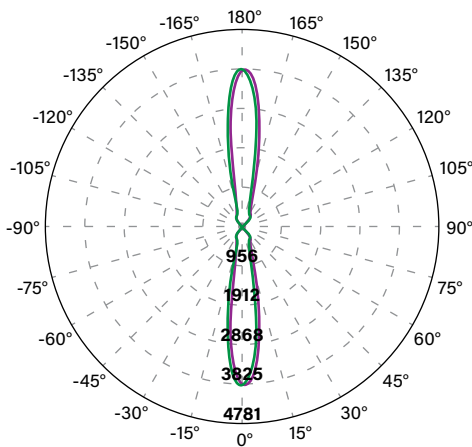

Average diffuse angle (50%) : 20°  
Unit: cd

- 1 Violet C0-C180
- 2 Green C90-C270

FLUX DISTRIBUTION

Zone	Lumens	% Luminaire
<b>Forward Light</b>	471 lm	24.8%
0°-30°	331 lm	17.4%
30°-60°	119 lm	6.3%
60°-80°	14 lm	0.7%
80°-90°	7 lm	0.4%
<b>Back Light</b>	488 lm	25.7%
0°-30°	346 lm	18.2%
30°-60°	122 lm	6.4%
60°-80°	14 lm	0.7%
80°-90°	6 lm	0.3%
<b>Up Light</b>	939 lm	49.5%
90°-100°	10 lm	0.5%
100°-180°	929 lm	48.9%

BUG* Rating	
<b>Asymmetrical Luminaire Types</b>	
Type I, II, III, IV	B1 U4 G0
<b>Quadrilateral Symmetrical Luminaire Types</b>	
Type V, Area Light	B1 U4 G0

\* Backlight, Uplight, Glare

### PHOTOMETRIC SPECIFICATIONS KT-CYLED20PS-4A-WDI-OSG-8CSB-VDIM (40° REFLECTOR WITH FULL ILLUMINATION)

ISOCANDELA PLOT

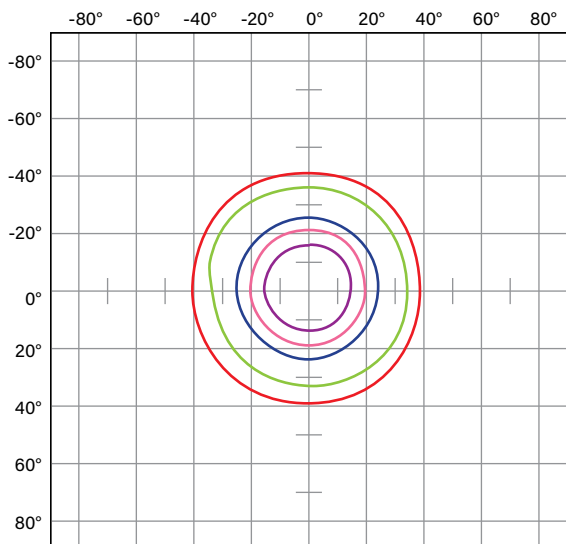

- Cd: 195, 10%
  - Cd: 312, 16%
  - Cd: 488, 25%
  - Cd: 781, 40%
  - Cd: 1230, 63%
- Point of Max Cd: 1952

LUMINOUS INTENSITY DISTRIBUTION

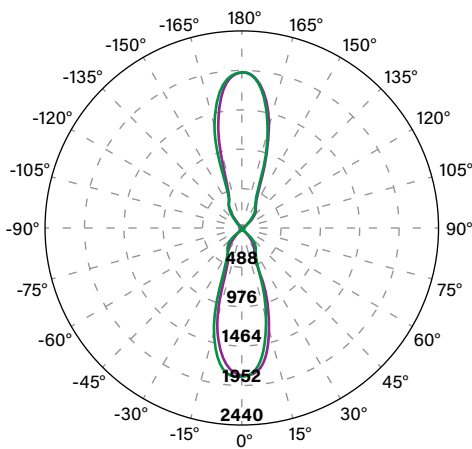

Average diffuse angle (50%) : 36°  
Unit: cd

- 1 Violet C0-C180
- 2 Green C90-C270

FLUX DISTRIBUTION

Zone	Lumens	% Luminaire
<b>Forward Light</b>	459 lm	23.6%
0°-30°	343 lm	17.6%
30°-60°	111 lm	5.7%
60°-80°	4 lm	0.2%
80°-90°	1 lm	0.1%
<b>Back Light</b>	521 lm	26.8%
0°-30°	384 lm	19.7%
30°-60°	132 lm	6.8%
60°-80°	4 lm	0.2%
80°-90°	1 lm	0.1%
<b>Up Light</b>	967 lm	49.7%
90°-100°	2 lm	0.1%
100°-180°	965 lm	49.6%

BUG* Rating	
<b>Asymmetrical Luminaire Types</b>	
Type I, II, III, IV	B1 U4 G0
<b>Quadrilateral Symmetrical Luminaire Types</b>	
Type V, Area Light	B1 U4 G0

\* Backlight, Uplight, Glare

(Photometric Specifications continued on next page)

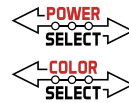

# KT-CYLEDXXPS-XA-WDI-OSG-8CSB-VDIM-X

## DIRECT/INDIRECT WALL MOUNT CYLINDER

### PHOTOMETRIC SPECIFICATIONS KT-CYLED20PS-4A-WDI-OSG-8CSB-VDIM (60° REFLECTOR WITH FULL ILLUMINATION)

#### ISOCANDELA PLOT

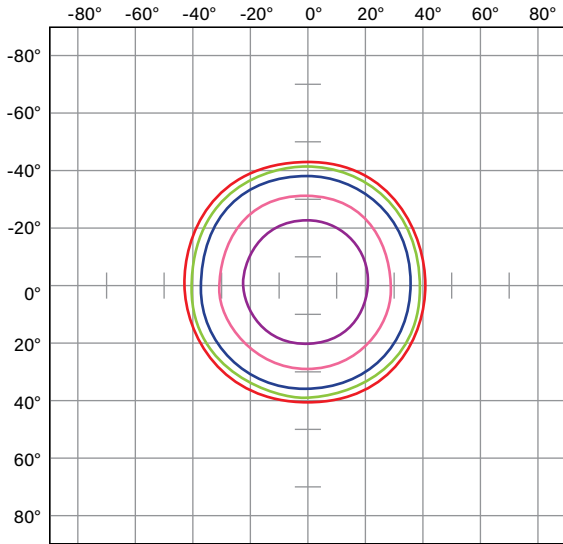

- Cd: 129, 10%
- Cd: 207, 16%
- Cd: 323, 25%
- Cd: 517, 40%
- Cd: 814, 63%
- Point of Max Cd: 1292

#### LUMINOUS INTENSITY DISTRIBUTION

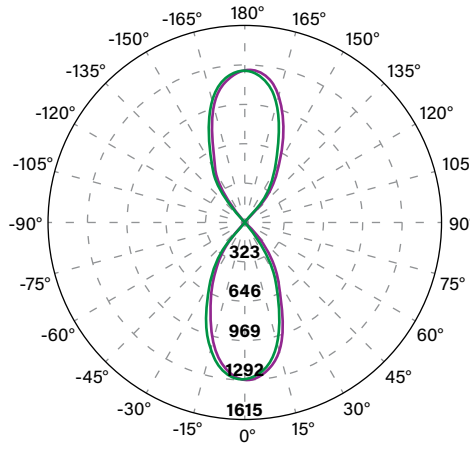

Average diffuse angle (50%) : 52°  
Unit: cd

- 1 Violet C0-C180
- 2 Green C90-C270

#### FLUX DISTRIBUTION

Zone	Lumens	% Luminaire
<b>Forward Light</b>	483 lm	24.2%
0°-30°	352 lm	17.6%
30°-60°	129 lm	6.5%
60°-80°	2 lm	0.1%
80°-90°	0 lm	0.0%
<b>Back Light</b>	523 lm	26.2%
0°-30°	369 lm	18.5%
30°-60°	152 lm	7.6%
60°-80°	2 lm	0.1%
80°-90°	0 lm	0.0%
<b>Up Light</b>	991 lm	49.6%
90°-100°	0 lm	0.0%
100°-180°	991 lm	49.6%

BUG* Rating	
<b>Asymmetrical Luminaire Types</b>	
Type I, II, III, IV	B1 U4 G0
<b>Quadrilateral Symmetrical Luminaire Types</b>	
Type V, Area Light	B1 U4 G0

\* Backlight, Uplight, Glare

### LIGHT DISTRIBUTION PATTERN

Photometric layouts for general reference only. Squares are 10ft x 10ft.

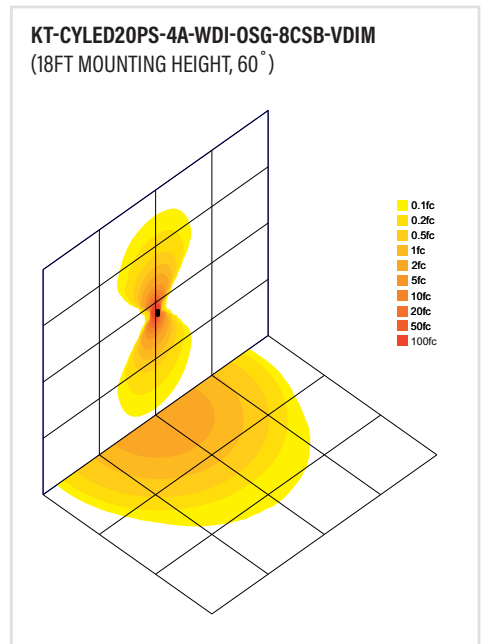
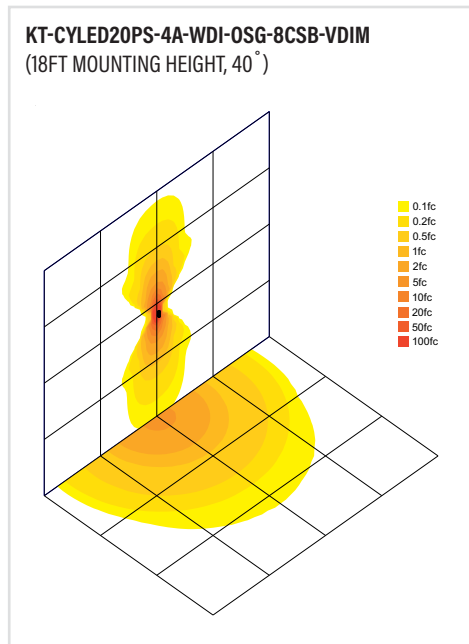
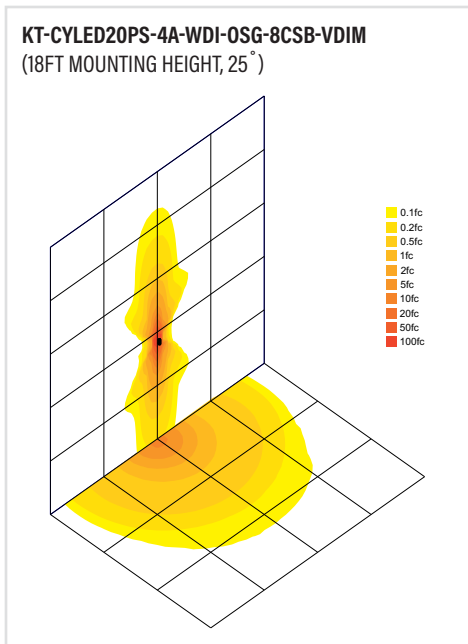

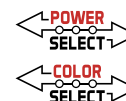

# KT-CYLEDXXPS-XA-WDI-OSG-8CSB-VDIM-X

## DIRECT/INDIRECT WALL MOUNT CYLINDER

### PHOTOMETRIC SPECIFICATIONS KT-CYLED36PS-6A-WDI-OSG-8CSB-VDIM (25° REFLECTOR WITH FULL ILLUMINATION)

ISOCANDELA PLOT

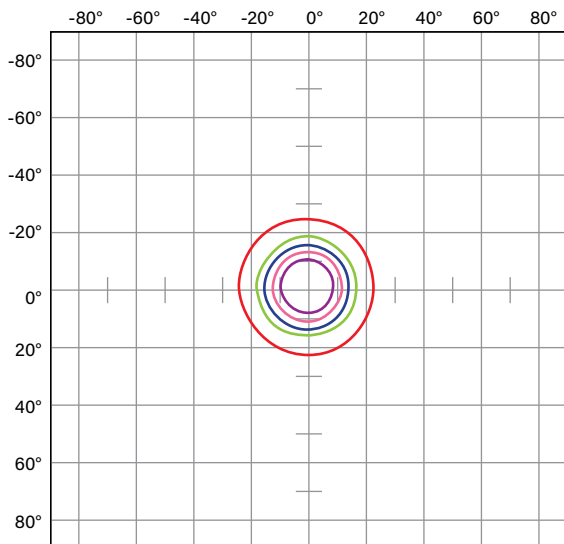

- Cd: 599, 10%
- Cd: 958, 16%
- Cd: 1497, 25%
- Cd: 2396, 40%
- Cd: 3773, 63%
- Point of Max Cd: 5989

LUMINOUS INTENSITY DISTRIBUTION

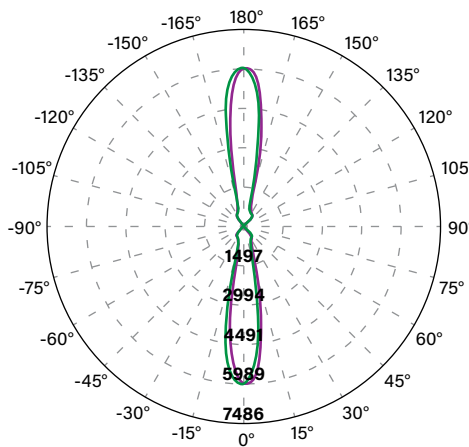

Average diffuse angle (50%) : 22°  
Unit: cd

- 1 Violet C0-C180
- 2 Green C90-C270

FLUX DISTRIBUTION

Zone	Lumens	% Luminaire
<b>Forward Light</b>	758 lm	23.4%
0°-30°	529 lm	16.3%
30°-60°	207 lm	6.4%
60°-80°	15 lm	0.5%
80°-90°	7 lm	0.2%
<b>Back Light</b>	862 lm	26.6%
0°-30°	605 lm	18.7%
30°-60°	234 lm	7.2%
60°-80°	15 lm	0.5%
80°-90°	7 lm	0.2%
<b>Up Light</b>	1623 lm	50.0%
90°-100°	13 lm	0.4%
100°-180°	1610 lm	49.6%

BUG* Rating	
<b>Asymmetrical Luminaire Types</b>	
Type I, II, III, IV	B2 U5 G0
<b>Quadrilateral Symmetrical Luminaire Types</b>	
Type V, Area Light	B2 U5 G0

\* Backlight, Uplight, Glare

### PHOTOMETRIC SPECIFICATIONS KT-CYLED36PS-6A-WDI-OSG-8CSB-VDIM (40° REFLECTOR WITH FULL ILLUMINATION)

ISOCANDELA PLOT

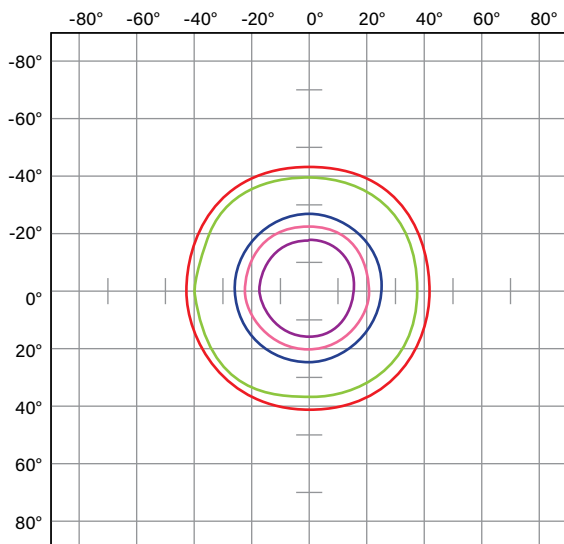

- Cd: 277, 10%
- Cd: 443, 16%
- Cd: 692, 25%
- Cd: 1107, 40%
- Cd: 1743, 63%
- Point of Max Cd: 2767

LUMINOUS INTENSITY DISTRIBUTION

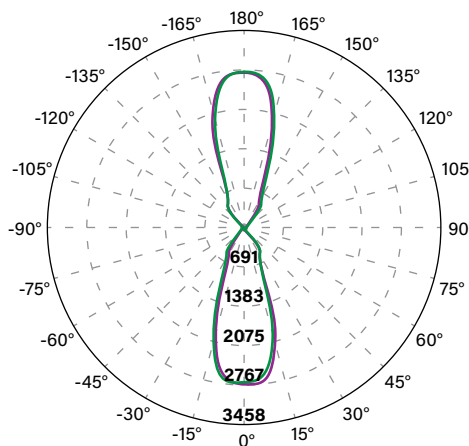

Average diffuse angle (50%) : 39°  
Unit: cd

- 1 Violet C0-C180
- 2 Green C90-C270

FLUX DISTRIBUTION

Zone	Lumens	% Luminaire
<b>Forward Light</b>	779 lm	24.1%
0°-30°	563 lm	17.5%
30°-60°	210 lm	6.5%
60°-80°	4 lm	0.1%
80°-90°	1 lm	0.0%
<b>Back Light</b>	826 lm	25.6%
0°-30°	595 lm	18.4%
30°-60°	225 lm	7.0%
60°-80°	5 lm	0.1%
80°-90°	1 lm	0.0%
<b>Up Light</b>	1623 lm	50.3%
90°-100°	2 lm	0.1%
100°-180°	1621 lm	50.2%

BUG* Rating	
<b>Asymmetrical Luminaire Types</b>	
Type I, II, III, IV	B2 U5 G0
<b>Quadrilateral Symmetrical Luminaire Types</b>	
Type V, Area Light	B2 U5 G0

\* Backlight, Uplight, Glare

(Photometric Specifications continued on next page)

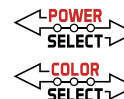

# KT-CYLEDXXPS-XA-WDI-OSG-8CSB-VDIM-X

## DIRECT/INDIRECT WALL MOUNT CYLINDER

### PHOTOMETRIC SPECIFICATIONS KT-CYLED36PS-6A-WDI-OSG-8CSB-VDIM (60° REFLECTOR WITH FULL ILLUMINATION)

#### ISOCANDELA PLOT

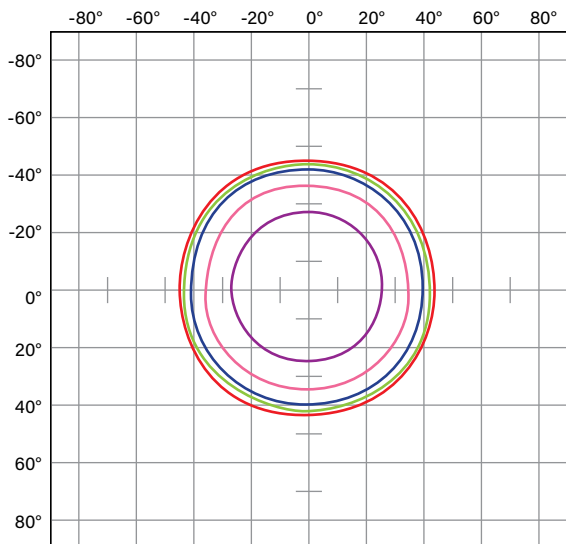

- Cd: 164 10%
- Cd: 263, 16%
- Cd: 410, 25%
- Cd: 1034, 63%
- Cd: 657, 40%
- Point of Max Cd: 1642

#### LUMINOUS INTENSITY DISTRIBUTION

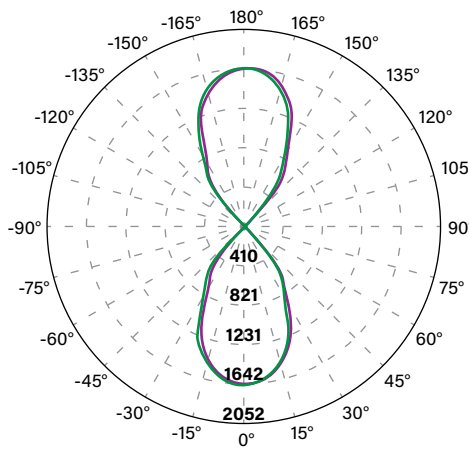

Average diffuse angle (50%) : 62°  
Unit: cd

- 1 Violet C0-C180
- 2 Green C90-C270

#### FLUX DISTRIBUTION

Zone	Lumens	% Luminaire
<b>Forward Light</b>	783 lm	24.1%
0°-30°	522 lm	16.1%
30°-60°	255 lm	7.9%
60°-80°	6 lm	0.2%
80°-90°	0 lm	0.0%
<b>Back Light</b>	840 lm	25.9%
0°-30°	541 lm	16.7%
30°-60°	292 lm	9.0%
60°-80°	7 lm	0.2%
80°-90°	0 lm	0.0%
<b>Up Light</b>	1623 lm	50.0%
90°-100°	0 lm	0.0%
100°-180°	1623 lm	50.0%

BUG* Rating	
<b>Asymmetrical Luminaire Types</b>	
Type I, II, III, IV	B2 U5 G0
<b>Quadrilateral Symmetrical Luminaire Types</b>	
Type V, Area Light	B2 U5 G0

\* Backlight, Uplight, Glare

### LIGHT DISTRIBUTION PATTERN

Photometric layouts for general reference only. Squares are 10ft x 10ft.

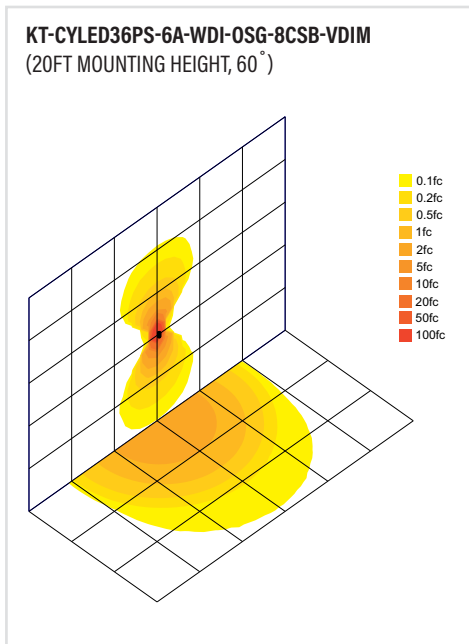
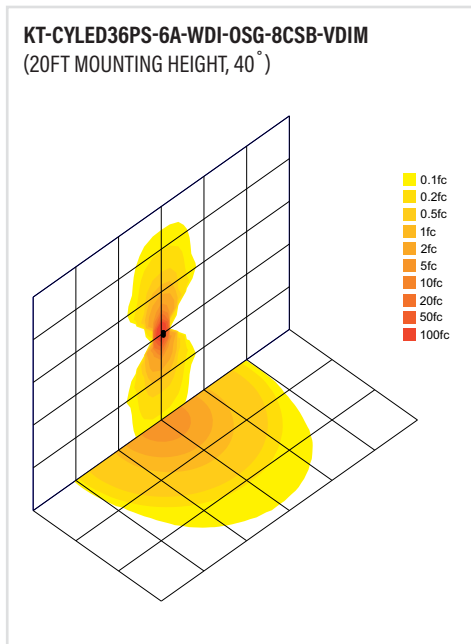
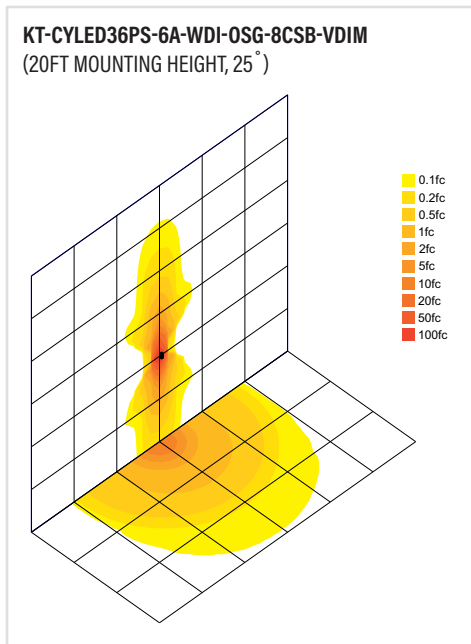

# KT-CYLEDXXPS-XA-WDI-OSG-8CSB-VDIM-X

## DIRECT/INDIRECT WALL MOUNT CYLINDER

### ACCESSORIES

*Note: All shell options are available for 3", 4", and 6" fixture sizes. See last page for ordering details.*

**BRONZE FIXTURE WITH SHELL**



**WHITE FIXTURE WITH SHELL**



**BLACK FIXTURE WITH SHELL**

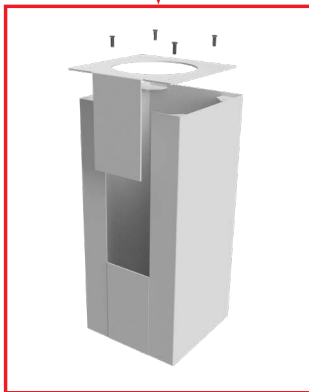



SENTINEL  
WALL MOUNT CYLINDER

Form FIT  
optic swap

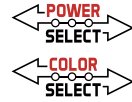

# KT-CYLEDXXPS-XA-WDI-OSG-8CSB-VDIM-X

## DIRECT/INDIRECT WALL MOUNT CYLINDER

### REFLECTOR REPLACEMENT



### WATTAGE, CCT, PHOTOCELL, AND DIRECTION SELECTION

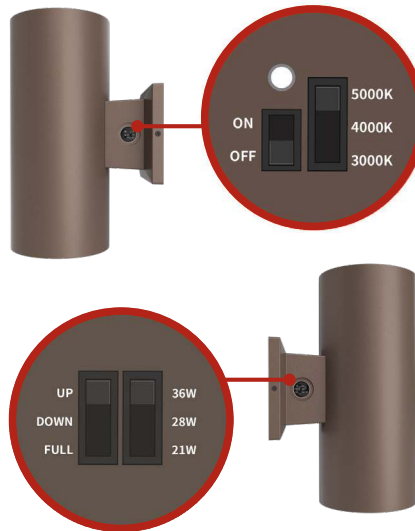

### FORM FIT SHELL ACCESSORY



**Note:** Fixtures are factory preset to their highest wattage and CCT values. Photocell preset to: ON. Direct/Indirect/Full preset to: Full

### PHYSICAL SPECIFICATIONS

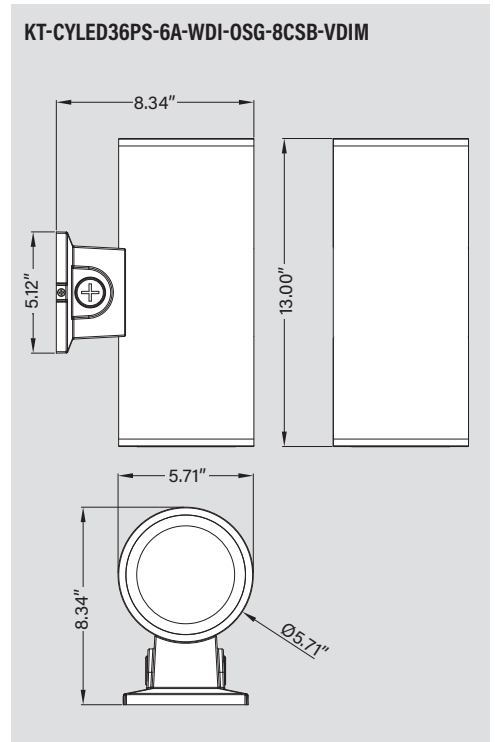
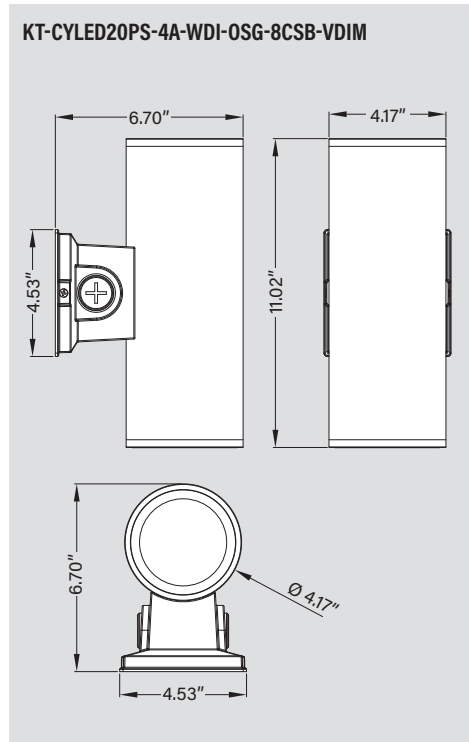
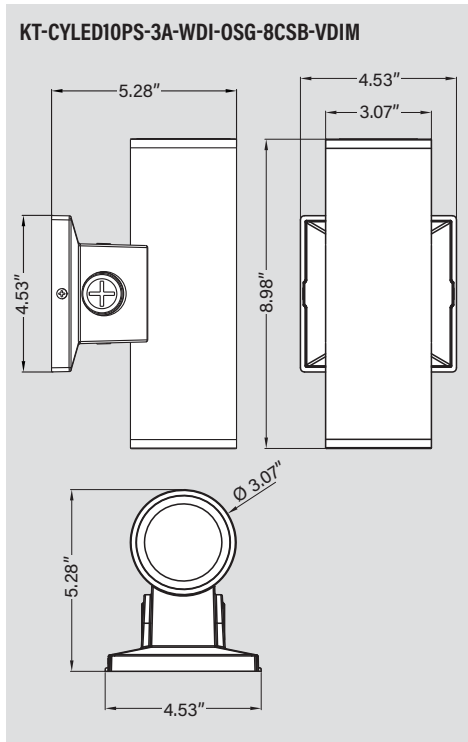

(Physical Specifications continued on next page)

# KT-CYLEDXXPS-XA-WDI-OSG-8CSB-VDIM-X

## DIRECT/INDIRECT WALL MOUNT CYLINDER

### PHYSICAL SPECIFICATIONS (continued)

#### 3" & 4" MOUNTING PLATE

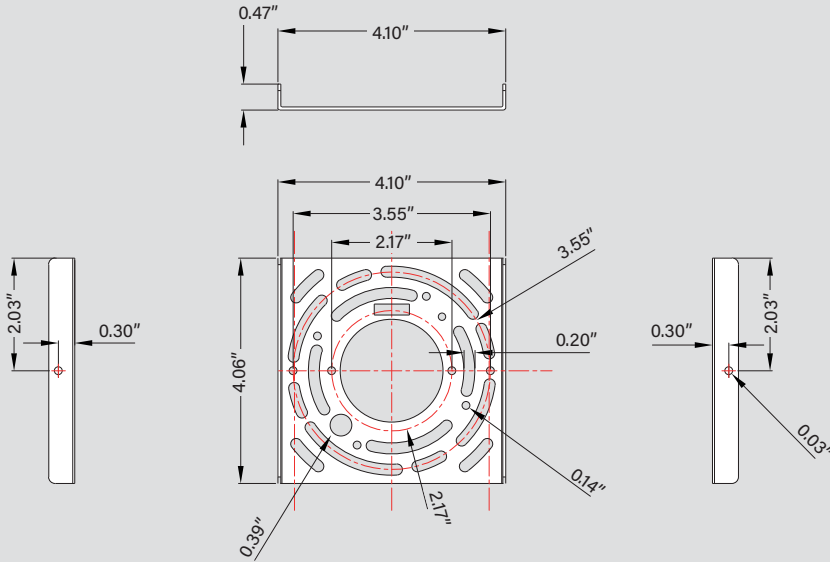

#### 6" MOUNTING PLATE

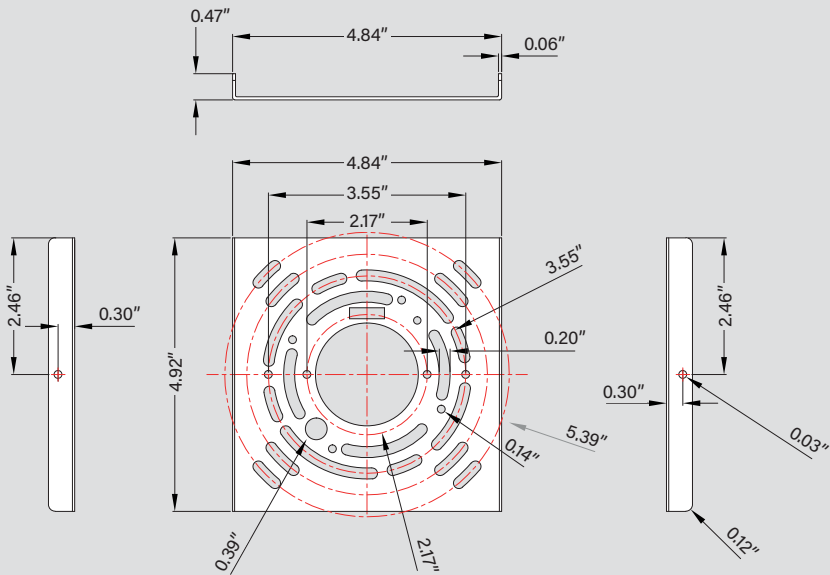

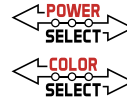

# KT-CYLEDXXPS-XA-WDI-OSG-8CSB-VDIM-X

## DIRECT/INDIRECT WALL MOUNT CYLINDER

**ACCESSORIES**

**SHELLS**

Field-Installable / Field-Use ONLY (purchased separately)

✓	CATALOG NUMBER	DESCRIPTION	HOUSING COLOR	UPC	EASY CODE
	KT-CYLED-6A-SQ-1-KIT	Square shell   Used on 6" wall mount cylinders	Bronze	843654162645	UME-71
	KT-CYLED-6A-SQ-1-KIT-W	Square shell   Used on 6" wall mount cylinders	White	843654162652	QFQ-38
	KT-CYLED-6A-SQ-1-KIT-B	Square shell   Used on 6" wall mount cylinders	Black	843654162669	JHI-09
	KT-CYLED-6A-SQ-1-KIT-U*	Square shell   Used on 6" wall mount cylinders	Unpainted	843654162676	LJE-49
	KT-CYLED-4A-SQ-1-KIT	Square shell   Used on 4" wall mount cylinders	Bronze	843654162683	DVY-80
	KT-CYLED-4A-SQ-1-KIT-W	Square shell   Used on 4" wall mount cylinders	White	843654162690	NGA-14
	KT-CYLED-4A-SQ-1-KIT-B	Square shell   Used on 4" wall mount cylinders	Black	843654162706	KBJ-66
	KT-CYLED-4A-SQ-1-KIT-U*	Square shell   Used on 4" wall mount cylinders	Unpainted	843654162713	CUL-90
	KT-CYLED-3A-SQ-1-KIT	Square shell   Used on 3" wall mount cylinders	Bronze	843654162720	RJL-53
	KT-CYLED-3A-SQ-1-KIT-W	Square shell   Used on 3" wall mount cylinders	White	843654162737	OSP-12
	KT-CYLED-3A-SQ-1-KIT-B	Square shell   Used on 3" wall mount cylinders	Black	843654162744	ZOK-59
	KT-CYLED-3A-SQ-1-KIT-U*	Square shell   Used on 3" wall mount cylinders	Unpainted	843654162751	AOW-72



\*Shell is unpainted. Custom color available. Must provide specific Pantone or RAL number. Lead times apply.

**ORDERING INFORMATION**

CATALOG NUMBER	UPC	EASY CODE
KT-CYLED36PS-6A-WDI-OSG-8CSB-VDIM	843654162553	JYZ-12
KT-CYLED36PS-6A-WDI-OSG-8CSB-VDIM-W	843654162560	GRG-58
KT-CYLED36PS-6A-WDI-OSG-8CSB-VDIM-B	843654162577	MAD-45
KT-CYLED20PS-4A-WDI-OSG-8CSB-VDIM	843654162584	PUZ-21
KT-CYLED20PS-4A-WDI-OSG-8CSB-VDIM-W	843654162591	XQM-86
KT-CYLED20PS-4A-WDI-OSG-8CSB-VDIM-B	843654162607	XQP-32
KT-CYLED10PS-3A-WDI-OSG-8CSB-VDIM	843654162614	ZZF-20
KT-CYLED10PS-3A-WDI-OSG-8CSB-VDIM-W	843654162621	XAN-82
KT-CYLED10PS-3A-WDI-OSG-8CSB-VDIM-B	843654162638	COV-46

**CATALOG NUMBER BREAKDOWN**

# KT-CYLEDXXPS-XA-WDI-OSG-8CSB-VDIM-X

<p><b>1</b> Keystone Technologies</p> <p><b>2</b> Cylinder LED</p> <p><b>3</b> Max Wattage</p> <p><b>4</b> Power Select</p> <p><b>5</b> Size</p> <p><b>6</b> Style A</p> <p><b>7</b> Wall Mount</p> <p><b>8</b> Orientation</p>	<p><b>9</b> Optic Swap</p> <p><b>10</b> Optic Swap Designation</p> <p><b>11</b> 80 CRI</p> <p><b>12</b> Color Select</p> <p><b>13</b> Color Select Designation</p> <p><b>14</b> Dimming</p> <p><b>15</b> Housing Color</p>	<p><b>5</b> Size</p> <table border="1" style="width: 100%;"> <tr><td>3</td><td>3" Diameter</td></tr> <tr><td>4</td><td>4" Diameter</td></tr> <tr><td>6</td><td>6" Diameter</td></tr> </table> <p><b>8</b> Orientation</p> <table border="1" style="width: 100%;"> <tr><td>DI</td><td>Direct/Indirect</td></tr> </table> <p><b>10</b> Optic Swap Designation</p> <table border="1" style="width: 100%;"> <tr><td>G</td><td>40° installed, 25° &amp; 60° included</td></tr> </table>	3	3" Diameter	4	4" Diameter	6	6" Diameter	DI	Direct/Indirect	G	40° installed, 25° & 60° included
3	3" Diameter											
4	4" Diameter											
6	6" Diameter											
DI	Direct/Indirect											
G	40° installed, 25° & 60° included											
		<p><b>11</b> Color Select Designation</p> <table border="1" style="width: 100%;"> <tr><td>B</td><td>3000/4000/5000K</td></tr> </table> <p><b>14</b> Dimming</p> <table border="1" style="width: 100%;"> <tr><td>VDIM</td><td>0-10V</td></tr> </table> <p><b>15</b> Housing Color</p> <table border="1" style="width: 100%;"> <tr><td></td><td>Bronze</td></tr> <tr><td>W</td><td>White</td></tr> <tr><td>B</td><td>Black</td></tr> </table>	B	3000/4000/5000K	VDIM	0-10V		Bronze	W	White	B	Black
B	3000/4000/5000K											
VDIM	0-10V											
	Bronze											
W	White											
B	Black											