



**HI-LITE MFG.
CO., INC**

13450 Monte Vista Avenue
Chino, California 91710
Telephone: (909) 465-1999
Toll Free: (800) 465-0211
Fax: (909) 465-0907
web: www.hilitemfg.com
e-mail: sales@hilitemfg.com

**H-2046
Mini RLM/Sign Lighter
Collection**

Job Name: _____
Type: _____
Quantity: _____

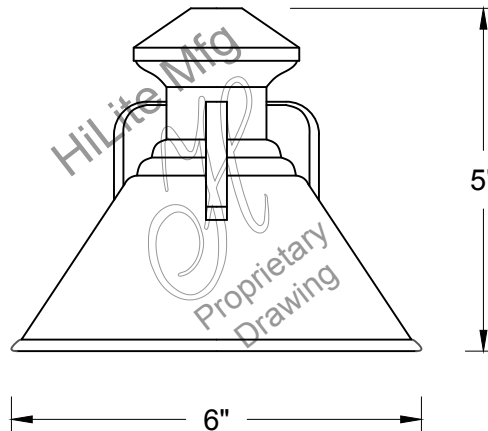

FINISH -Offered in exceptional finishes, comprised of: polyester/polished powder coat, baking enamel liquid, raw metal, or galvanized finishes.

Standard Finishes are: 91(Black), 93(White), 95(Dark Green), 96(Galvanized), BR47(Powder Coat Rust), BK01(Black Texture), GN20(Powder Coat Patina).

Upgraded Finishes are: 29, 66, 82, 90, 92, 94,97,99, 100, 103, 104, 105, 110, 110, 112, 113, 114, 115, 117, 118, 119, 120, 127, 128, 129, 133, 134, 135, 136, 11, 98, 101, 102, 137, 138, 139, 140, 121, 122, 123, 124, 125, 126, 01, 22, 25, 33, 77, 89, 24, 44, 48, 49, 15, 16, 55.

For interior finish of fixture refer to color chart on pages 344-348.

REFLECTOR - Heavy duty, spun shade, aluminum 6061-0 and/or 1100-0, galvanized 22 gauge, steel 20/22 gauge, copper 032/040 and brass 032/040 construction. Dependant on finish.

SOCKETS/LAMPS - Available in:
Incandescent
- rated 100 watt max/120 volt, medium base.

MOUNTING - Cord, Stem, Arm, and Flush mounting available.

MADE IN THE U.S.A.

Suitable for wet location.
(Except when cord mounted)

